

WPM2006

Power MOSFET and Schottky Diode

Features

- Featuring a MOSFET and Schottky Diode
- Independent Pinout to each Device to Ease Circuit Design
- Ultra Low V_F Schottky

Applications

- Li-Ion Battery Charging
- High Side DC-DC Conversion Circuits
- High Side Drive for Small Brushless DC Motors
- Power Management in Portable, Battery Powered Products

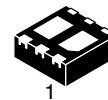
DFN2*2-6L

MOSFET MAXIMUM RATINGS ($T_J = 25^\circ\text{C}$ unless otherwise noted)

Parameter		Symbol	Value	Unit	
Drain-to-Source Voltage		V_{DSS}	-20	V	
Gate-to-Source Voltage		V_{GS}	± 8.0	V	
Continuous Drain Current (Note 1)	Steady State	I_D	$T_A = 25^\circ\text{C}$	-3	A
			$T_A = 85^\circ\text{C}$	-2.3	
	$t \leq 5 \text{ s}$	$T_A = 25^\circ\text{C}$	-4.1		
Power Dissipation (Note 1)	Steady State	P_D	$T_A = 25^\circ\text{C}$	1.45	W
	$t \leq 5 \text{ s}$			2.3	
Continuous Drain Current (Note 2)	Steady State	I_D	$T_A = 25^\circ\text{C}$	-2.0	A
			$T_A = 85^\circ\text{C}$	-1.5	
Power Dissipation (Note 2)	Steady State	P_D	$T_A = 25^\circ\text{C}$	0.7	W
Pulsed Drain Current	$t_p = 10 \mu\text{s}$	I_{DM}	-20	A	
Operating Junction and Storage Temperature		T_J, T_{STG}	-55 to 150	$^\circ\text{C}$	
Source Current (Body Diode) (Note 2)		I_S	-2	A	

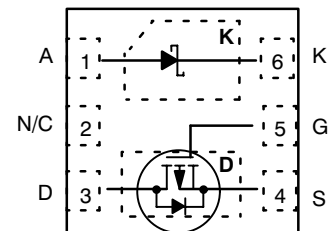
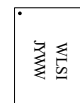
Pin connections:

Marking:

J = Specific Device Code
YWW = Date Code

1. Surface Mounted on FR4 Board using 1 in sq pad size, 2 oz Cu.
2. Surface Mounted on FR4 Board using minimum pad size, 2 oz Cu.

SCHOTTKY DIODE MAXIMUM RATINGS ($T_J = 25^\circ\text{C}$ unless otherwise noted)

Parameter	Symbol	Limits	Unit
Peak repetitive reverse voltage	V_{RRM}	20	V
DC Blocking voltage	V_R	20	V
Average rectified forward current	I_F	1	A

Order information

Part Number	Package	Shipping
WPM2006-6/TR	DFN 2*2- 6L	3000 Tape & Reel

THERMAL RESISTANCE RATINGS

Parameter	Symbol	Max	Unit
Junction-to-Ambient – Steady State (Note 3)	$R_{\theta JA}$	86	°C/W
Junction-to-Ambient – $t \leq 5$ s (Note 3)	$R_{\theta JA}$	54	
Junction-to-Ambient – Steady State Min Pad (Note 4)	$R_{\theta JA}$	175	

3. Surface Mounted on FR4 Board using 1 in sq pad size, 2 oz Cu.

4. Surface Mounted on FR4 Board using the minimum pad size, 2 oz Cu.

MOSFET ELECTRICAL CHARACTERISTICS($T_J = 25^\circ\text{C}$ unless otherwise specified)

Parameter	Symbol	Test Condition	Min	Typ	Max	Units
Off Characteristics						
Drain-Source Breakdown Voltage	BV_{DSS}	$V_{GS} = 0V, I_D = -250\mu A$	-20			V
Zero Gate Voltage Drain Current	I_{DSS}	$V_{DS} = -16V, V_{GS} = 0V$			-1	μA
Gate-Source leakage current	I_{GSS}	$V_{GS} = \pm 8V, V_{DS} = 0V$			± 100	nA
On Characteristics						
Gate Threshold Voltage	$V_{GS(th)}$	$V_{GS} = V_{DS}, I_D = -250\mu A$	-0.4	-0.6	-1	V
Static Drain-Source On-Resistance	$R_{DS(on)}$	$V_{GS} = -4.5V, I_D = -2.8A$		90	120	$m\Omega$
		$V_{GS} = -2.5V, I_D = -2.0A$		110	150	$m\Omega$
Forward Transconductance	g_{FS}	$V_{DS} = -10V, I_D = -2.7A$		7.0		S
Dynamic Characteristics						
Input Capacitance	C_{iss}	$V_{DS} = -15V, V_{GS} = 0V,$ $f = 1.0$ MHz		480		pF
Output Capacitance	C_{oss}			46		pF
Reverse Transfer Capacitance	C_{rss}			10		pF
Switching Characteristics						
Turn-On Delay Time	$t_{d(on)}$	$V_{GS} = -4.5V, V_{DS} = -6V,$ $R_L = 6\Omega, R_G = 6\Omega,$		38		ns
Turn-On Rise Time	t_r			25		ns
Turn-Off Delay Time	$t_{d(off)}$			43		ns
Turn-Off Fall Time	t_f			5		ns
Total Gate Charge	$Q_{G(TOT)}$	$V_{DS} = -6V, I_D = -2.8A,$ $V_{GS} = -4.5V$		7.2		nC
Threshold gate charge	$Q_{G(TH)}$			1.0		nC
Gate-Source Charge	Q_{GS}			2.2		nC
Gate-Drain Charge	Q_{GD}			1.2		nC
Drain-Source Diode Characteristics and Maximum Ratings						
Forward Diode Voltage	V_{SD}	$V_{GS} = 0V, I_S = -1$ A		-0.7	-1.5	V

SCHOTTKY DIODE ELECTRICAL CHARACTERISTICS ($T_J = 25^\circ\text{C}$ unless otherwise noted)

Parameter	Symbol	Min.	Typ.	Max.	Unit	Conditions
Forward voltage	V_{F1}		0.425		V	$I_F = 0.1A$
	V_{F2}		0.480			$I_F = 0.5A$
	V_{F3}			0.575		$I_F = 1A$
Reverse current	I_{R1}			20	μA	$V_R = 10V$
	I_{R2}			100	μA	$V_R = 20V$

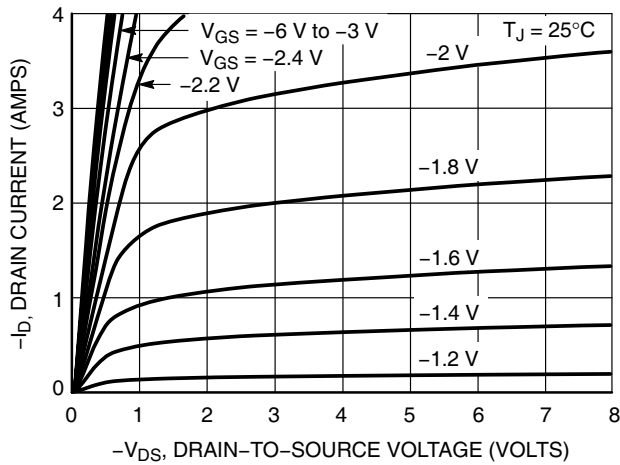
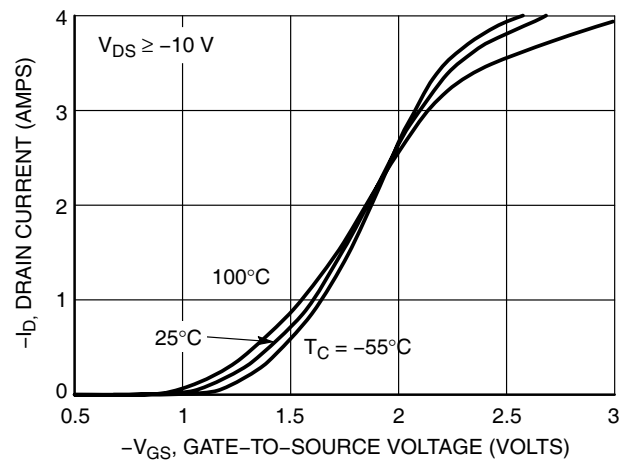
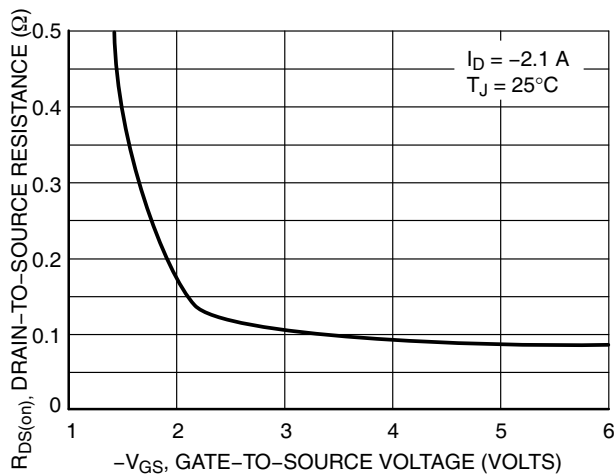
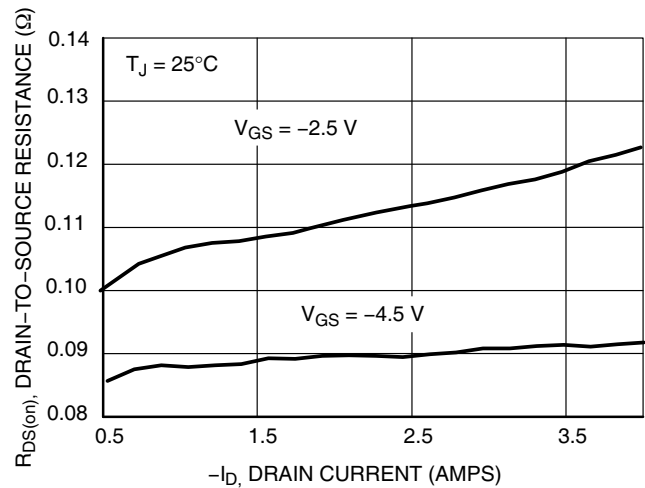
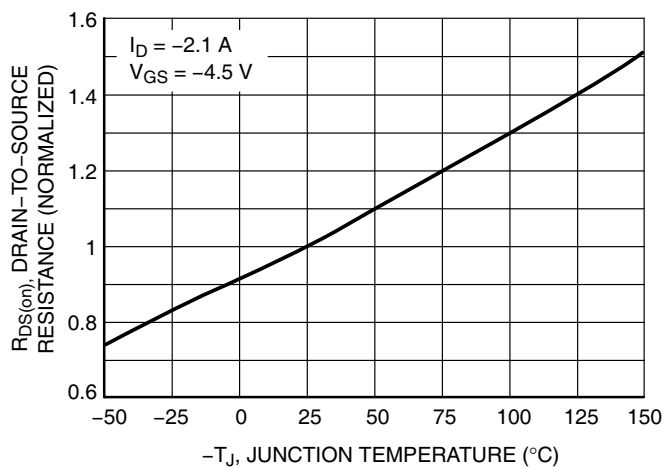
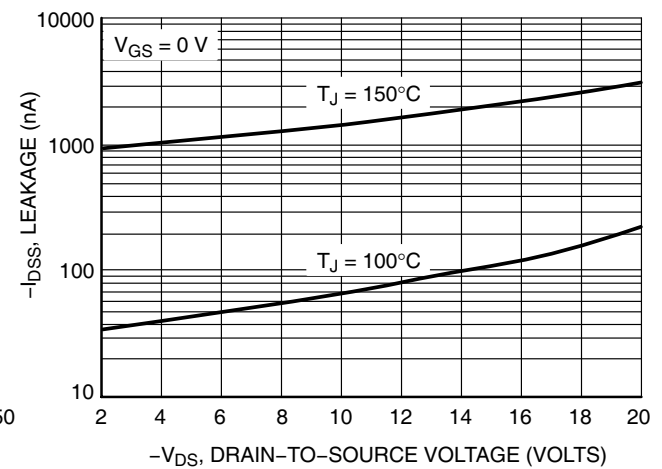
Typical Characteristics ($T_J = 25^\circ\text{C}$ unless otherwise noted)

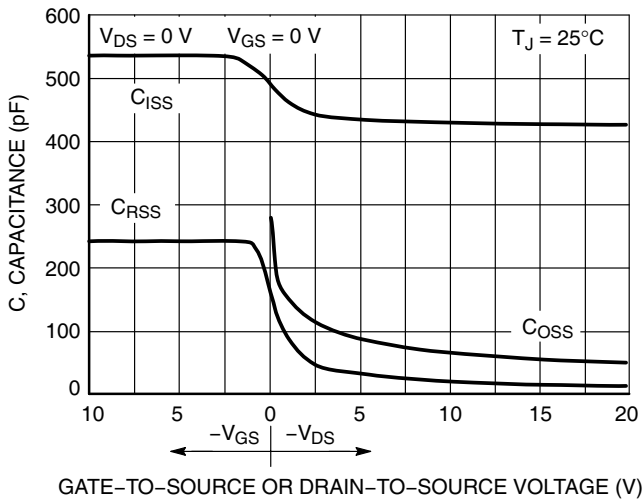
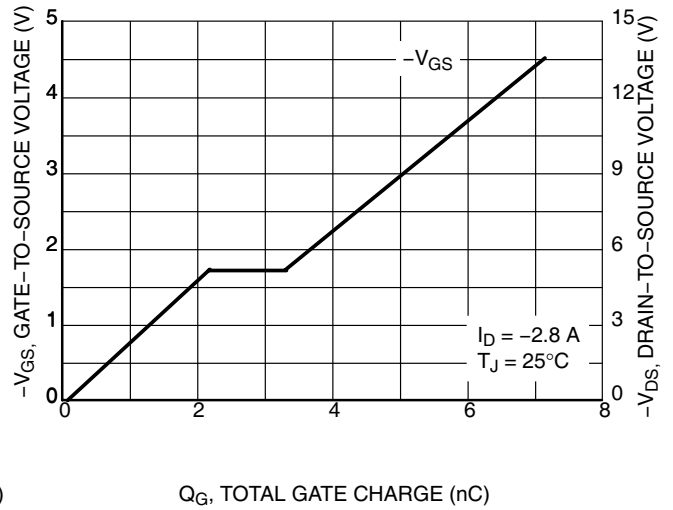
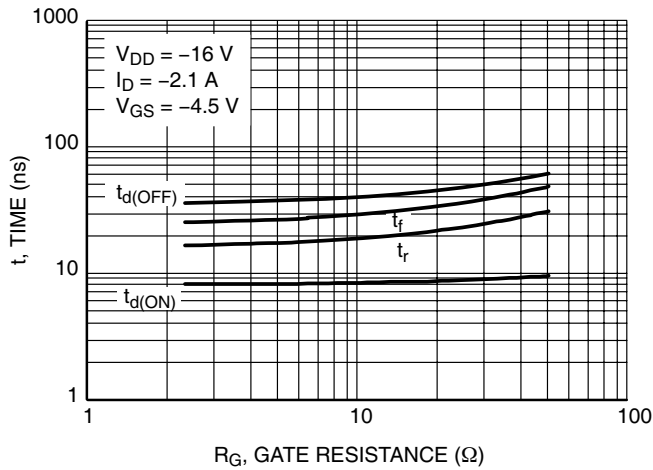
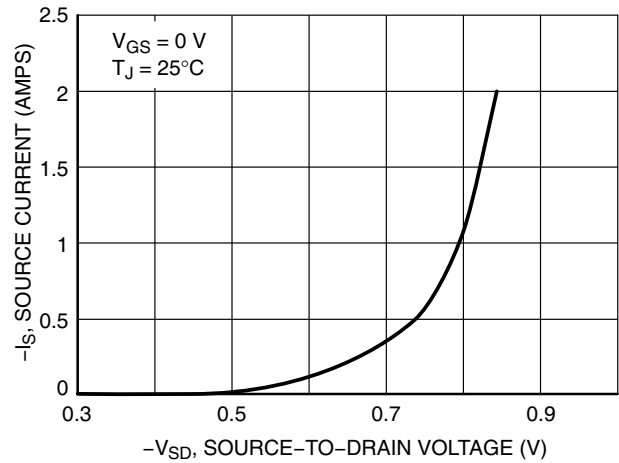
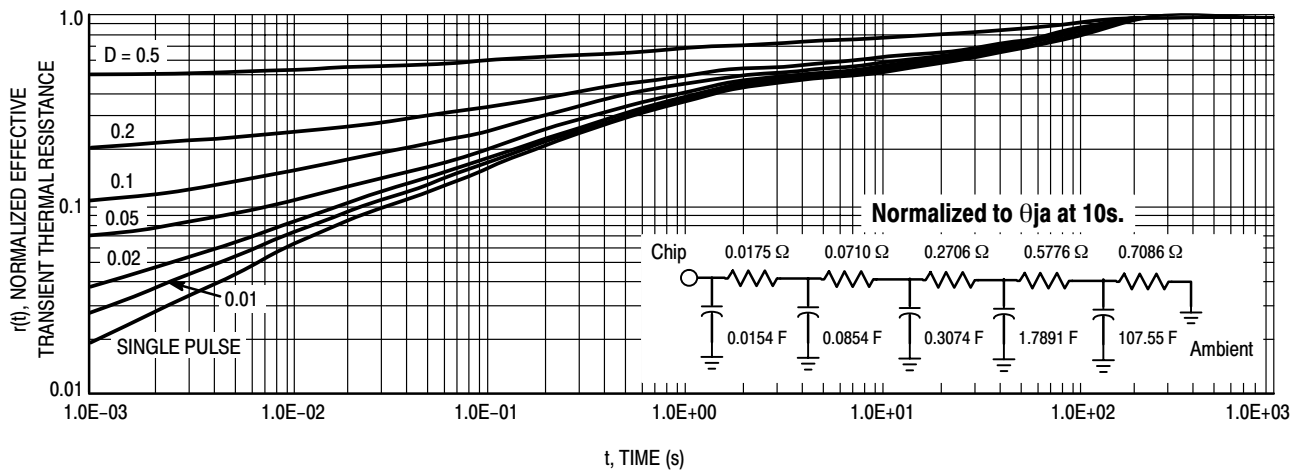
Figure 1. On-Region Characteristics

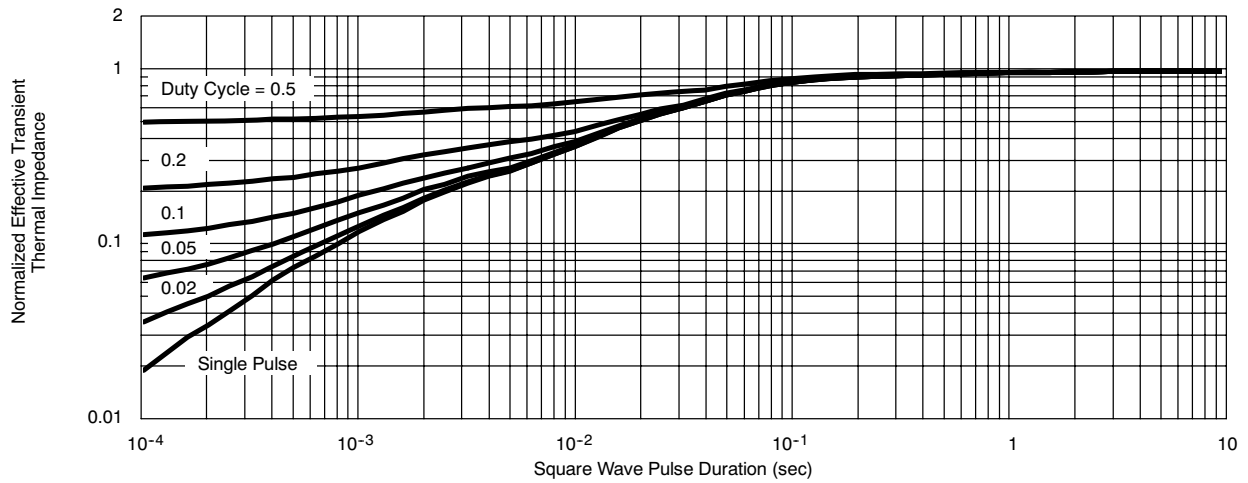
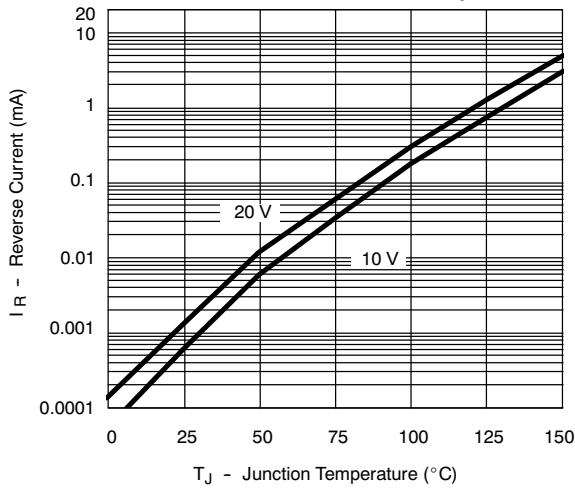
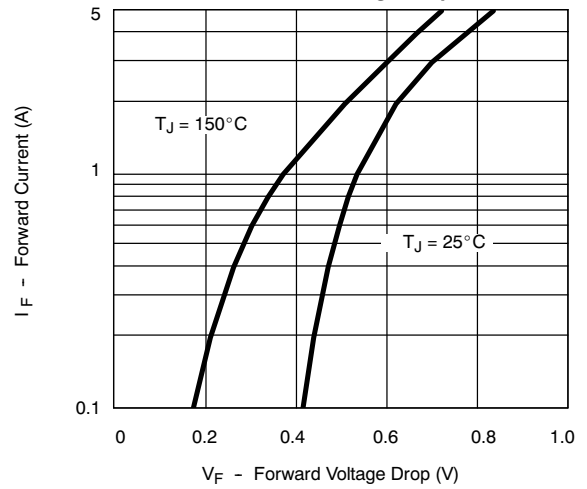
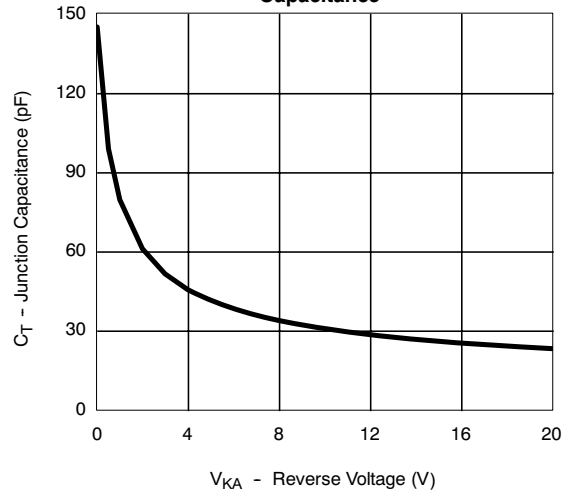
Figure 2. Transfer Characteristics

Figure 3. On-Resistance vs. Gate-to-Source Voltage

Figure 4. On-Resistance vs. Drain Current and Gate Voltage

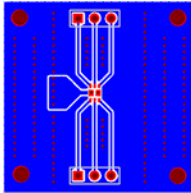
Figure 5. On-Resistance Variation with Temperature

Figure 6. Drain-to-Source Leakage Current vs. Voltage

Figure 7. Capacitance Variation

Figure 8. Gate-to-Source and Drain-to-Source Voltage vs. Total Charge

Figure 9. Resistive Switching Time Variation vs. Gate Resistance

Figure 10. Diode Forward Voltage vs. Current

Figure 11. Thermal Response

Normalized Thermal Transient Impedance, Junction-to-Foot

Reverse Current vs. Junction Temperature

Forward Voltage Drop

Capacitance

Power Dissipation Characteristics

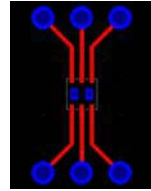
1. The package of WPM2006 is DFN2x2-6L, surface mounted on FR4 Board using 1 in sq pad size, 2 oz Cu, $R_{\theta JA}$ is $84^{\circ}\text{C}/\text{W}$, surface mounted on FR4 Board using minimum pad size, 2 oz Cu, $R_{\theta JA}$ is $175^{\circ}\text{C}/\text{W}$.
2. The power dissipation PD is based on $T_J(\text{MAX})=150^{\circ}\text{C}$, and the relation between T_J and Pd is $T_J = T_a + R_{\theta JA} * PD$, the maximum power dissipation is determined by $R_{\theta JA}$.
3. The $R_{\theta JA}$ is the thermal impedance from junction to ambient, using larger PCB pad size can get smaller $R_{\theta JA}$ and result in larger maximum power dissipation.



$84^{\circ}\text{C}/\text{W}$ when mounted on
a 1 in² pad of 2 oz copper



$175^{\circ}\text{C}/\text{W}$ when mounted on
a minimum pad of 2 oz copper

DFNWB2×2-6L PACKAGE OUTLINE DIMENSIONS

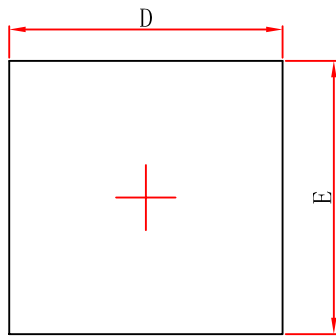

Top View

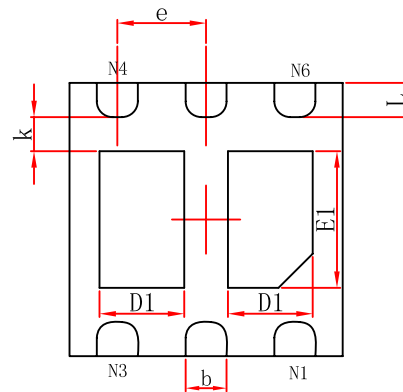

Bottom View

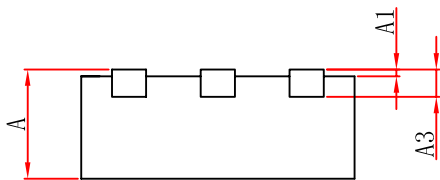

Side View

Symbol	Dimensions In Millimeters		Dimensions In Inches	
	Min.	Max.	Min.	Max.
A	0.700	0.800	0.028	0.031
A1	0.000	0.050	0.000	0.002
A3	0.203REF.		0.008REF.	
D	1.924	2.076	0.076	0.082
E	1.924	2.076	0.076	0.082
D1	0.520	0.720	0.020	0.028
E1	0.900	1.100	0.035	0.043
k	0.200MIN.		0.008MIN.	
b	0.250	0.350	0.010	0.014
e	0.650TYP.		0.026TYP.	
L	0.174	0.326	0.007	0.013

DFN2*2- 6L PCB Layout Guide

