

2μA I_Q, 300mA Low-Dropout Linear Regulator

General Description

The RT9078 is a low-dropout (LDO) voltage regulators with enable function that operates from 1.2V to 5.5V. It provides up to 300mA of output current and offers low-power operation in miniaturized packaging.

The features of low quiescent current as low as 2μA and almost zero disable current is ideal for powering the battery equipment to a longer service life. The RT9078 is stable with the ceramic output capacitor over its wide input range from 1.2V to 5.5V and the entire range of output load current (0mA to 300mA).

Pin Configuration

(TOP VIEW)

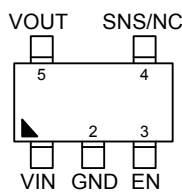

TSOT-23-5

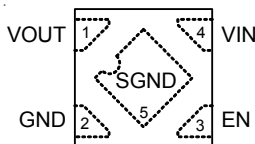

ZQFN-4L 1x1 (ZDFN-4L 1x1)

Features

- 2μA Ground Current at no Load
- PSRR = 75dB at 1kHz
- Adjustable Output Voltage Available by Specific Application
- ±2% Output Accuracy
- 300mA (V_{IN} ≥ 1.7V) Output Current with EN
- Low (0.1μA) Disable Current
- 1.2V to 5.5V Operating Input Voltage
- Dropout Voltage : 0.15V at 300mA when V_{OUT} ≥ 3V
- Support Fixed Output Voltage 0.8V, 1.0V, 1.05V, 1.1V, 1.2V, 1.25V, 1.3V, 1.5V, 1.8V, 1.85V, 2.5V, 2.8V, 2.85V, 3V, 3.1V, 3.3V, 3.45V
- Stable with Ceramic or Tantalum Capacitor
- Current Limit Protection
- Over Temperature Protection
- TSOT-23-5 and ZQFN-4L 1x1 (ZDFN-4L 1x1) Packages Available

Applications

- Portable, Battery Powered Equipment
- Ultra Low Power Microcontrollers
- Notebook Computers

Ordering Information

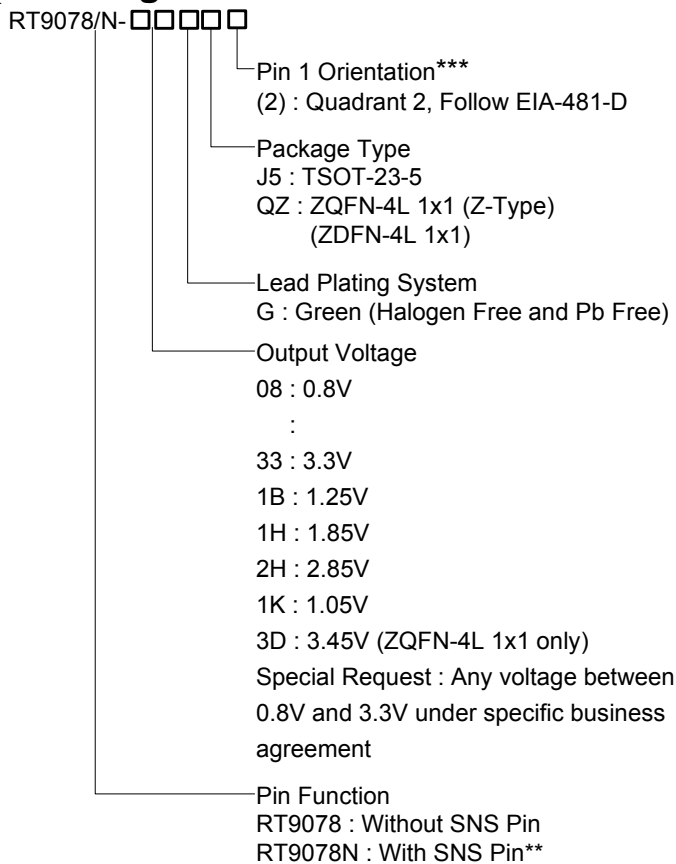

Marking Information

For marking information, contact our sales representative directly or through a Richtek distributor located in your area.

Note :

***Empty means Pin1 orientation is Quadrant 1

Richtek products are :

**Available for output target adjustment (Ex : RT9078N-08GJ5 with 0.8V reference level for output target adjustment)

- ▶ RoHS compliant and compatible with the current requirements of IPC/JEDEC J-STD-020.
- ▶ Suitable for use in SnPb or Pb-free soldering processes.

Functional Pin Description

Pin No.		Pin Name	Pin Function
TSOT-23-5	ZQFN-4L 1x1 (ZDFN-4L 1x1)		
1	4	VIN	Supply voltage input.
2	2	GND	Ground.
3	3	EN	Enable control input.
4	--	SNS	Output voltage sense. (RT9078N only)
		NC	No internal connection.
5	1	VOUT	Output of the regulator.
--	5 (Exposed Pad)	SGND	Substrate of chip. Leave floating or tie to GND.

Functional Block Diagram

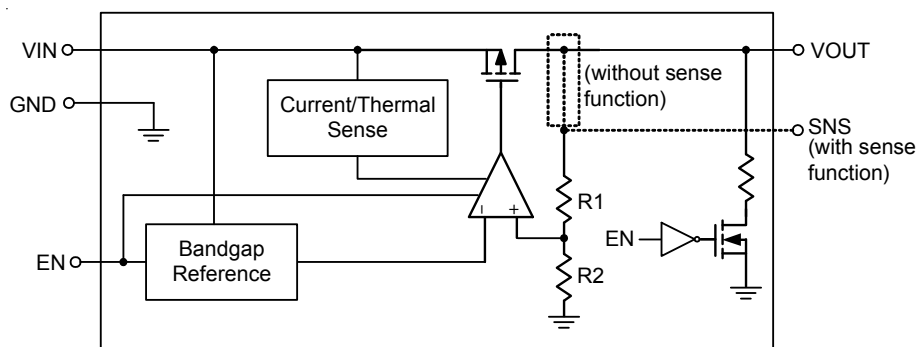

Operation

Basic operation

The RT9078 is a low quiescent current linear regulator designed especially for low external components system. The input voltage range is from 1.2V to 5.5V.

The minimum required output capacitance for stable operation is 1 μ F capacitance after consideration of the temperature and voltage coefficient of the capacitor.

Output Transistor

The RT9078 builds in a P-MOSFET output transistor which provides a low switch-on resistance for low dropout voltage applications.

Error Amplifier

The Error Amplifier compares the internal reference voltage with the output feedback voltage from the internal divider, and controls the Gate voltage of P-MOSFET to support good line regulation and load regulation at output voltage.

Enable

The RT9078 delivers the output power when it is set to enable state. When it works in disable state, there is no output power and the operation quiescent current is almost zero.

Current Limit Protection

The RT9078 provides current limit function to prevent the device from damages during over-load or shorted-circuit condition. This current is detected by an internal sensing transistor.

Over Temperature Protection

The over temperature protection function will turn off the P-MOSFET when the junction temperature exceeds 150°C (typ.), and the output current exceeds 80mA. Once the junction temperature cools down by approximately 20°C, the regulator will automatically resume operation.

Absolute Maximum Ratings (Note 1)

• VIN, VOUT, SNS, EN to GND	-----	-0.3V to 6.5V
• VOUT to VIN	-----	-6.5V to 0.3V
• Power Dissipation, P _D @ T _A = 25°C		
TSOT-23-5	-----	0.43W
ZQFN-4L 1x1 (ZDFN-4L 1x1)	-----	0.44W
• Package Thermal Resistance (Note 2)		
TSOT-23-5, θ _{JA}	-----	230.6°C/W
TSOT-23-5, θ _{JC}	-----	21.8°C/W
ZQFN-4L 1x1 (ZDFN-4L 1x1), θ _{JA}	-----	226°C/W
ZQFN-4L 1x1 (ZDFN-4L 1x1), θ _{JC}	-----	43°C/W
• Lead Temperature (Soldering, 10 sec.)	-----	260°C
• Junction Temperature	-----	150°C
• Storage Temperature Range	-----	-65°C to 150°C
• ESD Susceptibility (Note 3)		
HBM (Human Body Model)	-----	2kV

Recommended Operating Conditions (Note 4)

• Input Voltage, VIN	-----	1.2V to 5.5V
• Junction Temperature Range	-----	-40°C to 125°C
• Ambient Temperature Range	-----	-40°C to 85°C

Electrical Characteristics

(V_{OUT} + 1 < V_{IN} < 5.5V, T_A = 25°C, unless otherwise specified)

Parameter	Symbol	Test Conditions	Min	Typ	Max	Unit
Fixed Output Voltage Range	V _{OUT}		0.8	--	3.3	V
DC Output Accuracy		I _{LOAD} = 1mA	-2	--	2	%
Dropout Voltage (I _{LOAD} = 300mA) (Note 5)	V _{DROP}	0.8V ≤ V _{OUT} < 1.05V	--	0.7	0.97	V
		1.05V ≤ V _{OUT} < 1.2V	--	0.5	0.92	
		1.2V ≤ V _{OUT} < 1.5V	--	0.4	0.57	
		1.5V ≤ V _{OUT} < 1.8V	--	0.3	0.47	
		1.8V ≤ V _{OUT} < 2.1V	--	0.24	0.33	
		2.1V ≤ V _{OUT} < 2.5V	--	0.21	0.3	
		2.5V ≤ V _{OUT} < 2.8V	--	0.18	0.25	
		2.8V ≤ V _{OUT} < 3V	--	0.16	0.23	
		3V ≤ V _{OUT}	--	0.15	0.2	
V _{CC} Consumption Current	I _Q	I _{LOAD} = 0mA, V _{OUT} ≤ 5.5V V _{IN} ≥ V _{OUT} + V _{DROP}	--	2	4	μA
Shutdown GND Current (Note 6)		V _{EN} = 0V	--	0.1	0.5	μA
Shutdown Leakage Current (Note 6)		V _{EN} = 0V, V _{OUT} = 0V	--	0.1	0.5	μA

Parameter	Symbol	Test Conditions	Min	Typ	Max	Unit	
EN Input Current	I _{EN}	V _{EN} = 5.5V	--	--	0.1	μA	
Line Regulation	ΔLINE	I _{LOAD} = 1mA	1.2V ≤ V _{IN} < 1.5V	--	0.3	0.6	%
			1.5V ≤ V _{IN} < 1.8V	--	0.15	0.3	
			1.8V ≤ V _{IN} ≤ 5.5V	--	0.13	0.35	
Load Regulation	ΔLOAD	1mA < I _{LOAD} < 300mA	--	0.5	1	%	
Power Supply Rejection Ratio	PSRR	V _{IN} = 3V, I _{LOAD} = 50mA, C _{OUT} = 1μF, V _{OUT} = 2.5V, f = 1kHz	--	75	--	dB	
Output Voltage Noise		C _{OUT} = 1μF, I _{LOAD} = 150mA, BW = 10Hz to 100kHz, V _{IN} = V _{OUT} + 1V	V _{OUT} = 0.8V	--	38	--	μV _{RMS}
			V _{OUT} = 1.2V	--	46	--	
			V _{OUT} = 1.8V	--	48	--	
			V _{OUT} = 3.3V	--	51	--	
Output Current Limit	I _{LIM}	V _{OUT} = 90%V _{OUT(Normal)}	350	600	--	mA	
Enable Input Voltage	Logic-High	V _{IH}	V _{IN} = 5V	0.9	--	--	V
	Logic-Low	V _{IL}	V _{IN} = 5V	--	--	0.4	
Thermal Shutdown Temperature	T _{SD}	I _{LOAD} = 30mA, V _{IN} ≥ 1.5V	--	150	--	°C	
Thermal Shutdown Hysteresis	ΔT _{SD}		--	20	--	°C	
Discharge Resistance		EN = 0V, V _{OUT} = 0.1V	--	80	--	Ω	

Note 1. Stresses beyond those listed “Absolute Maximum Ratings” may cause permanent damage to the device. These are stress ratings only, and functional operation of the device at these or any other conditions beyond those indicated in the operational sections of the specifications is not implied. Exposure to absolute maximum rating conditions may affect device reliability.

Note 2. θ_{JA} is measured in the natural convection at T_A = 25°C on a two-layer Richtek Evaluation Board for ZQFN-4L 1x1 (ZDFN-4L1x1) Package.

θ_{JA} is measured at T_A = 25°C on a high effective thermal conductivity four-layer test board per JEDEC 51-7 for TSOT-23-5 Package.

Note 3. Devices are ESD sensitive. Handling precaution is recommended.

Note 4. The device is not guaranteed to function outside its operating conditions.

Note 5. The dropout voltage is defined as V_{IN} – V_{OUT}, when V_{OUT} is 98% of the normal value of V_{OUT}.

Note 6. The specification is tested at wafer stage and guarantee by design after assembly.

Typical Application Circuit

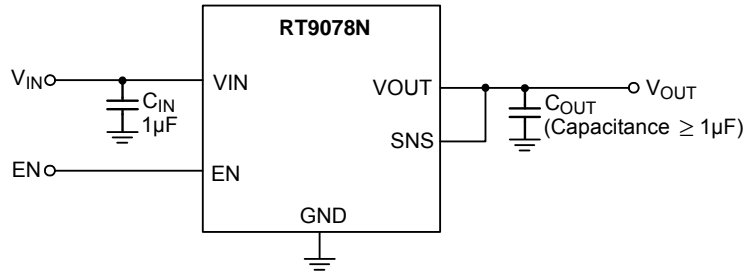

Figure 1. Application with Sense Function

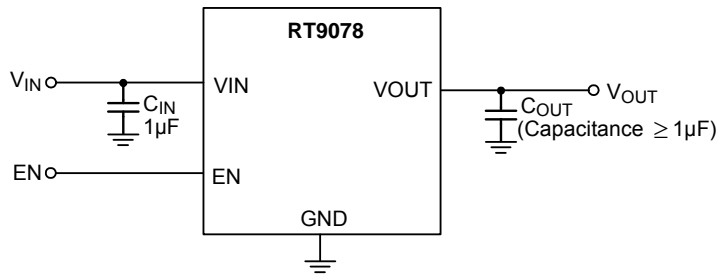

Figure 2. Application without Sense Function

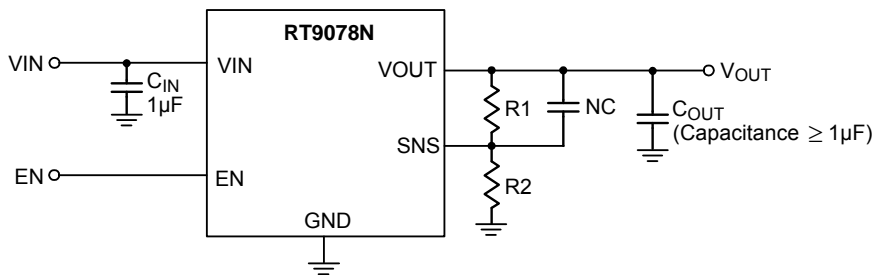
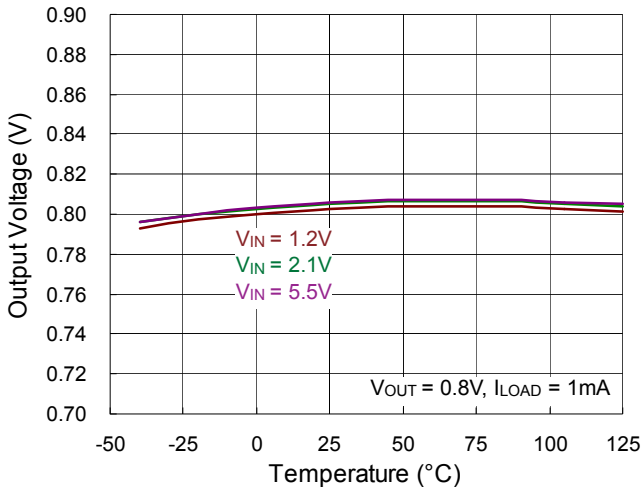

Figure 3. Adjustable Output Voltage Application Circuit

Typical Operating Characteristics

Output Voltage vs. Temperature



Output Voltage vs. Temperature

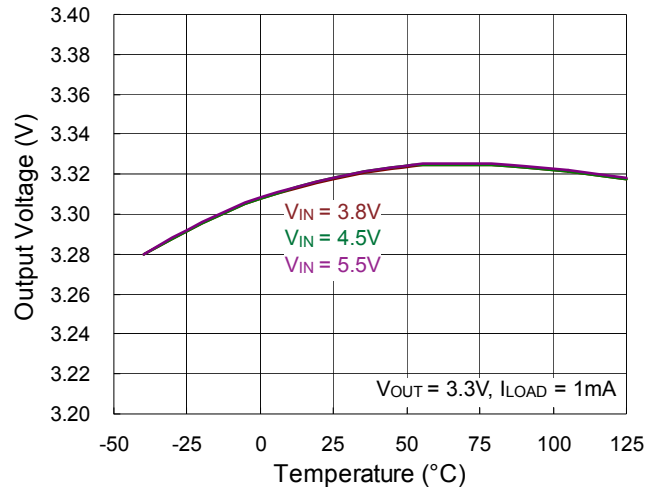

Output Voltage vs. Input Voltage

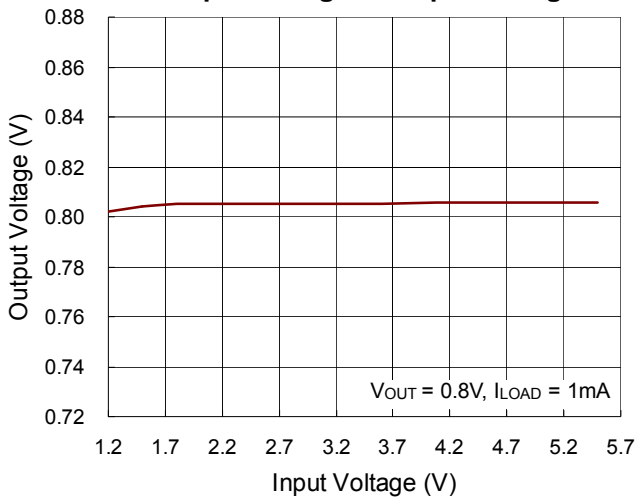

Output Voltage vs. Load Current

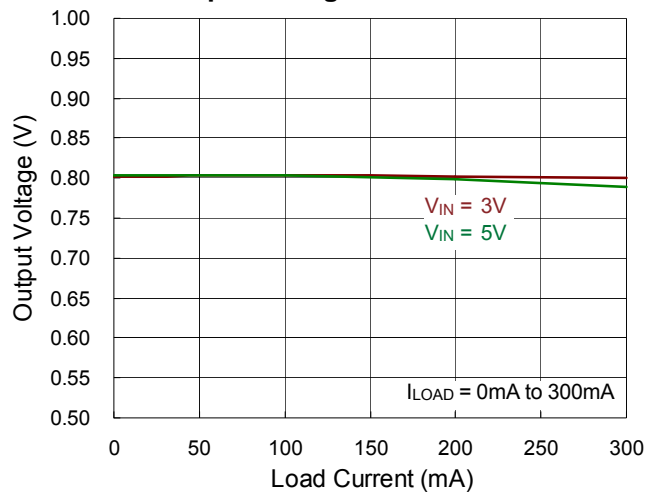

Ground Current vs. Load Current

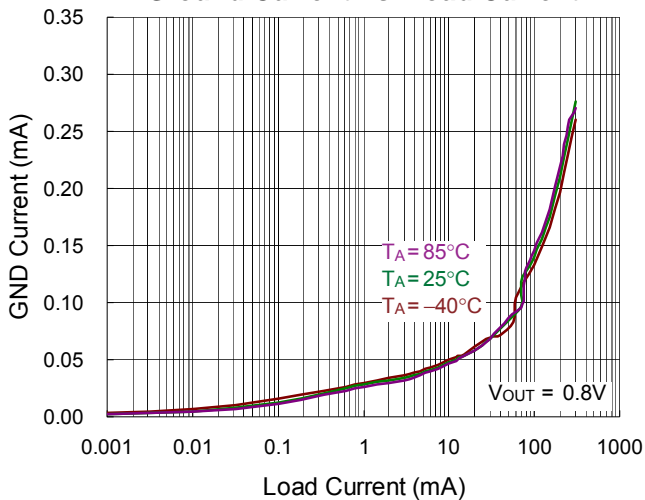

Ground Current vs. Load Current

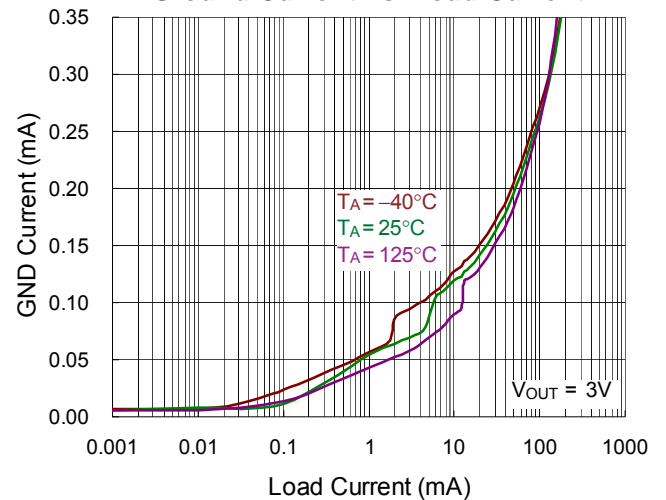

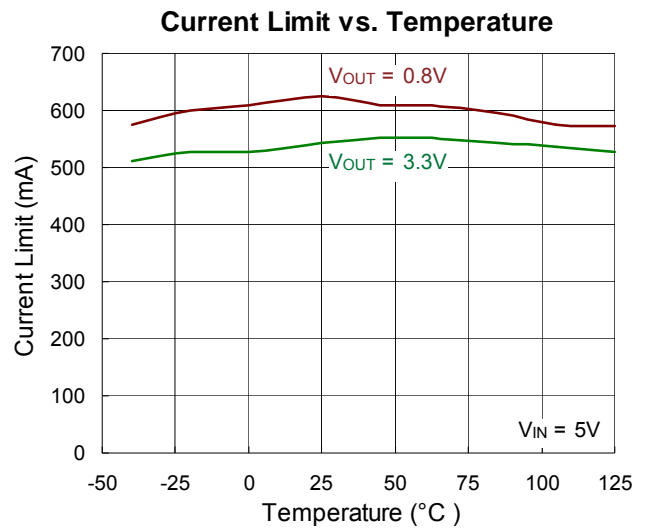
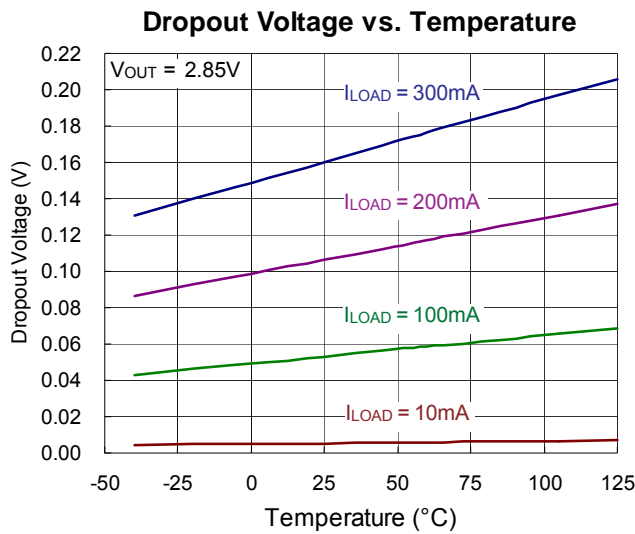
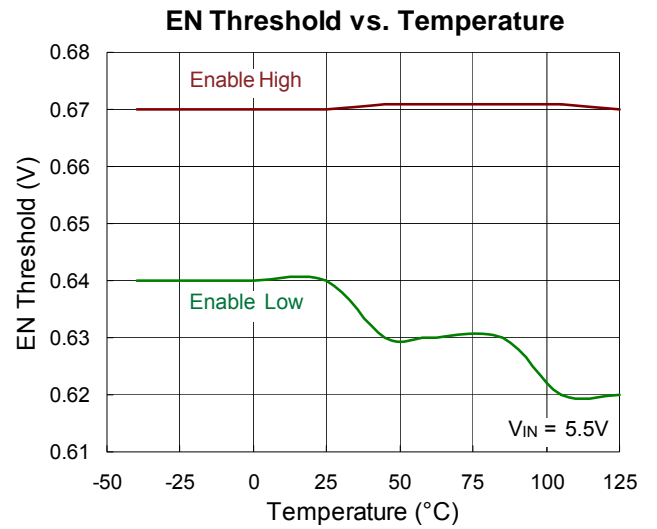
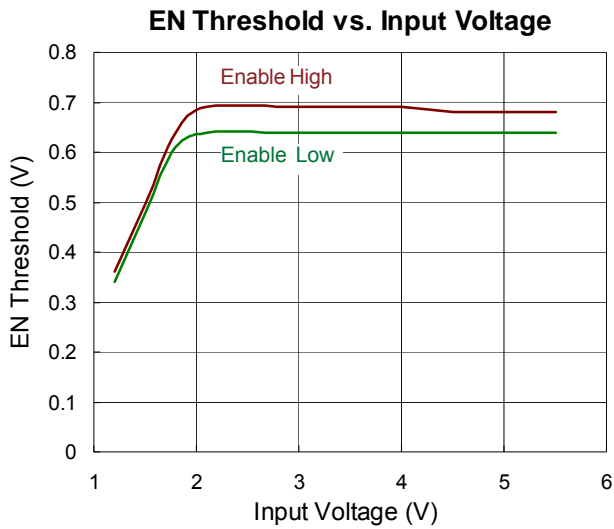
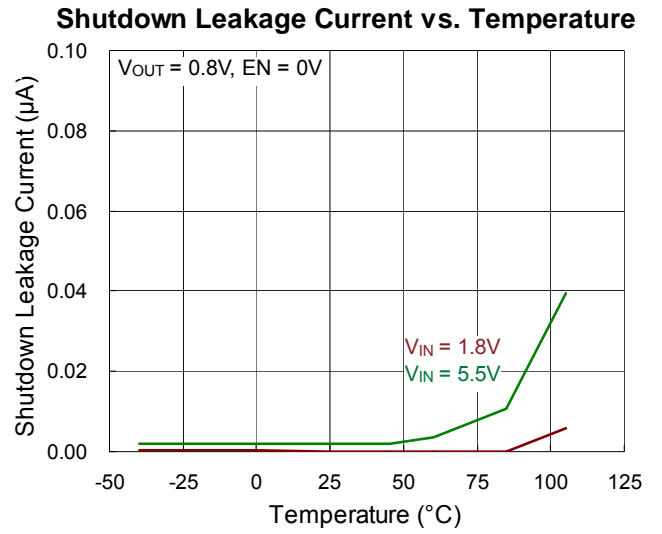
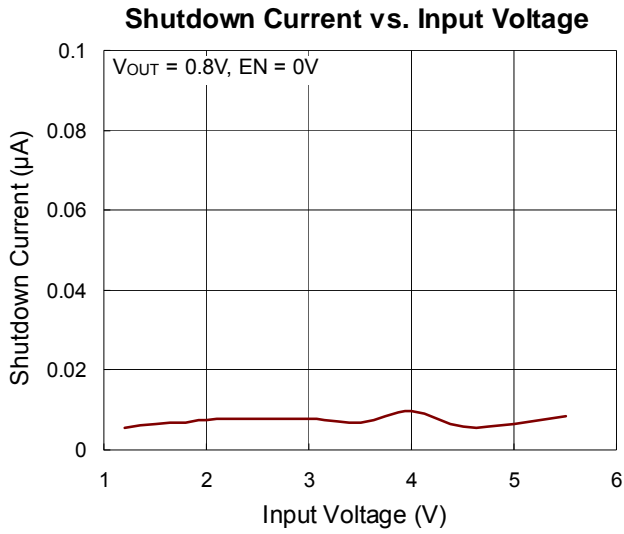

Fold-Back Current Limit vs. Temperature

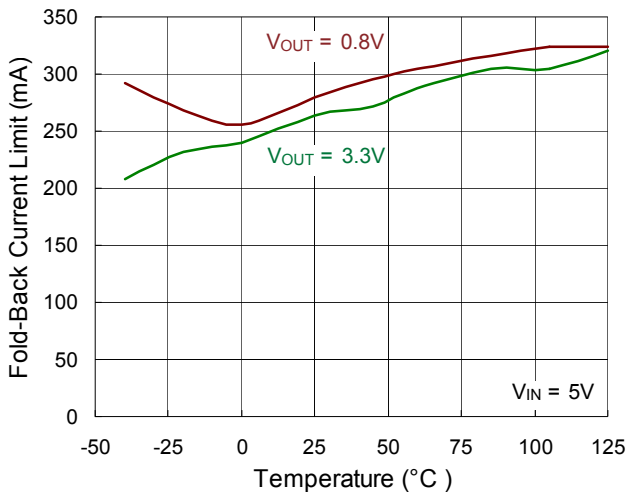

SNS Input Current vs. Temperature

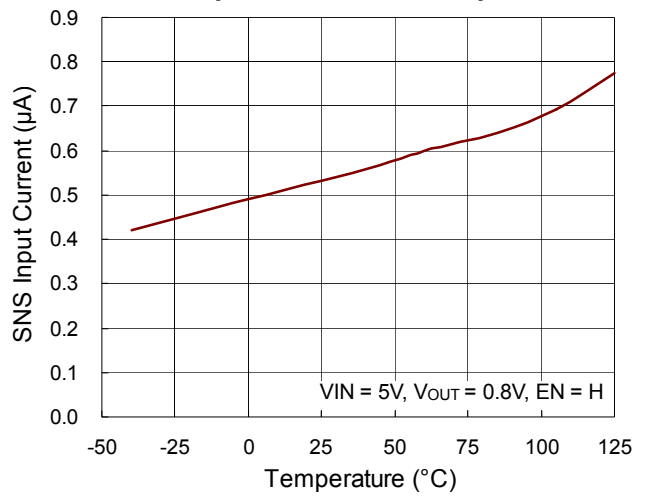

Power On from EN

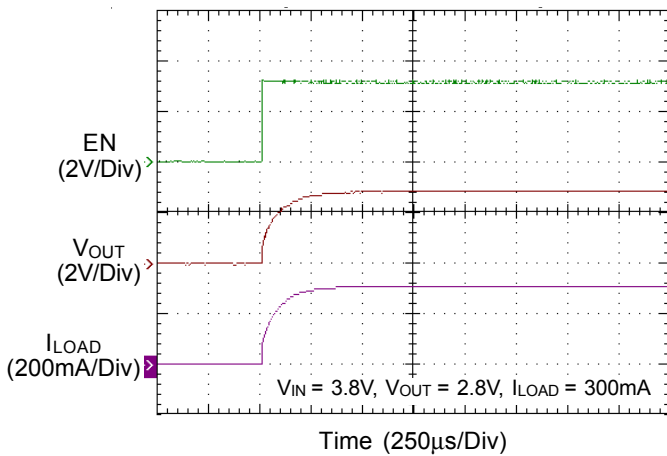

Power Off from EN

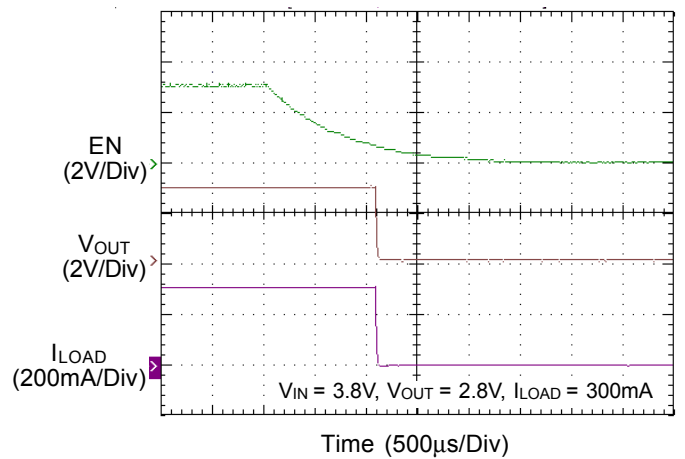

Line Transient

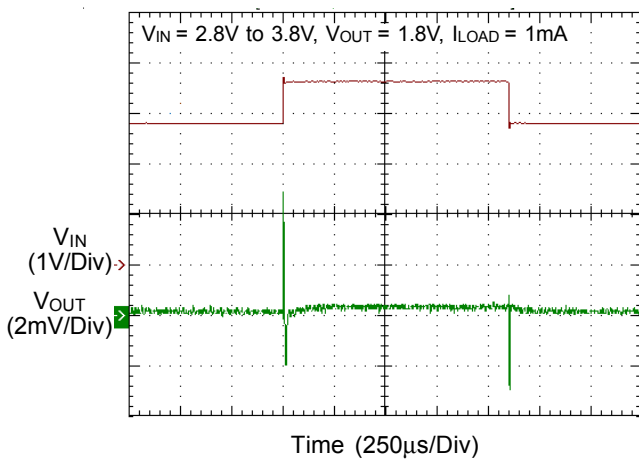

Load Transient

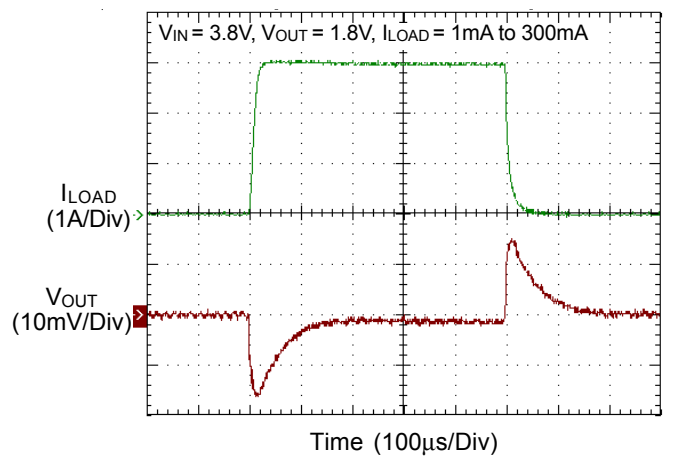

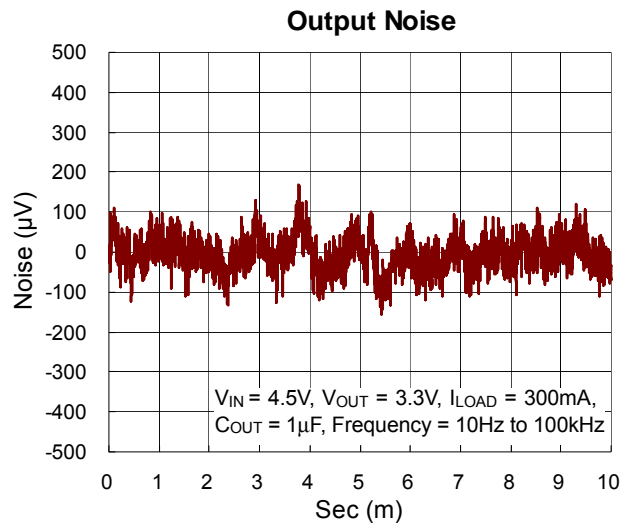
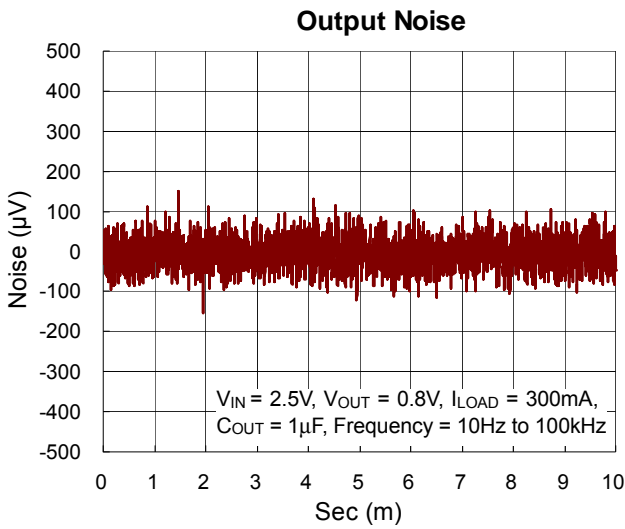
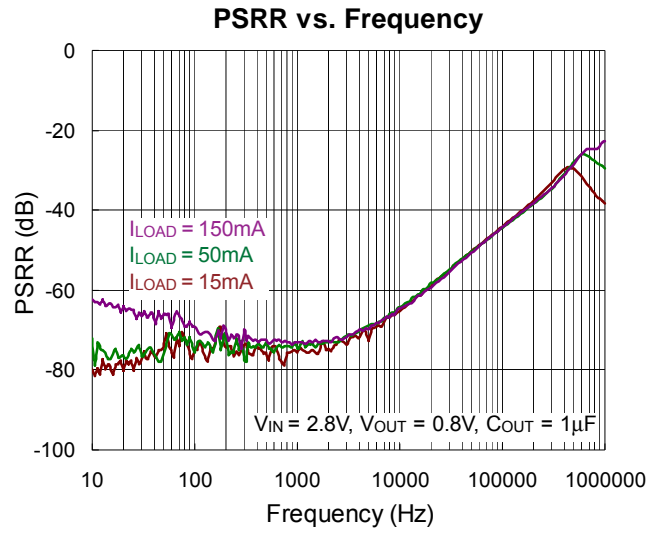
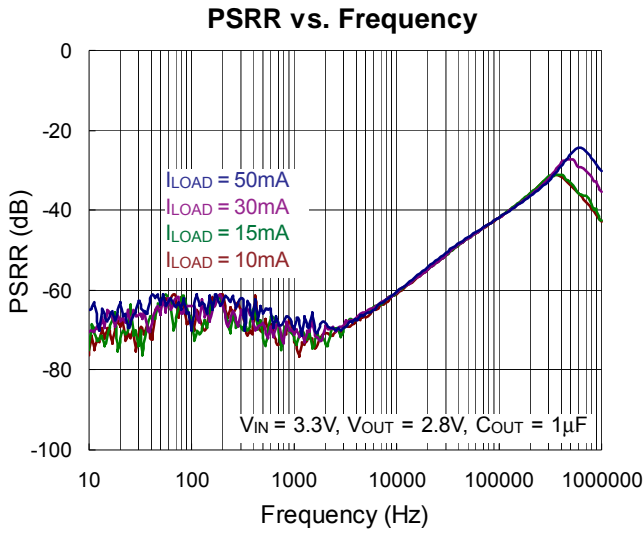

Application Information

Like any low dropout linear regulator, the RT9078's external input and output capacitors must be properly selected for stability and performance. Use a 1μF or larger input capacitor and place it close to the IC's VIN and GND pins. Any output capacitor meeting the minimum 1mΩ ESR (Equivalent Series Resistance) and capacitance larger than 1μF requirement may be used. Place the output capacitor close to the IC's VOUT and GND pins. Increasing capacitance and decreasing ESR can improve the circuit's PSRR and line transient response.

Enable

The RT9078 has an EN pin to turn on or turn off the regulator, When the EN pin is in logic high, the regulator will be turned on. The shutdown current is almost 0μA typical. The EN pin may be directly tied to VIN to keep the part on. The Enable input is CMOS logic and cannot be left floating.

Adjustable Output Voltage Setting

Because of the small input current at the SNS pin, the RT9078N with SNS pin also can work as an adjustable output voltage LDO. Figure 3 gives the connections for the adjustable output voltage application. The resistor divider from VOUT to SNS sets the output voltage when in regulation.

The voltage on the SNS pin sets the output voltage and is determined by the values of R1 and R2. In order to keep a good temperature coefficient of output voltage, the values of R1 and R2 should be selected carefully to ignore the temperature coefficient of input current at the SNS pin. A current greater than 50μA in the resistor divider is recommended to meet the above requirement. The adjustable output voltage can be calculated using the formula given in equation 1 :

$$V_{OUT} = \frac{R1 + R2}{R2} \times V_{SNS} \tag{1}$$

where V_{SNS} is determined by the output voltage selections in the ordering information of RT9078N. The maximum adjustable output voltage can be as high as input voltage deducted by the dropout voltage.

When we choose 51kΩ and 16kΩ as R1 and R2 respectively, and select a 0.8V output at SNS pin, the

adjustable output voltage will be set to around 3.35V. Its temperature coefficient in Figure 4 is still perfect in such kind of application.

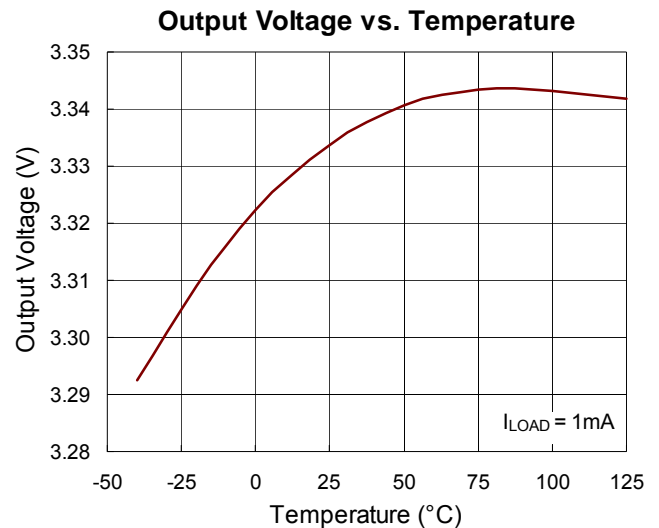

Figure 4. Temperature Coefficient of Adjustable Output Voltage

The minimum recommended 50μA in the resistor divider makes the application no longer an ultra low quiescent LDO. Figure 5 is another fine adjustable output voltage application can keep the LDO still operating in low power consumption. The fine tune range is recommended to be less than 50mV (R1 ≤ 91kΩ) in order to keep a good temperature coefficient of the output voltage.

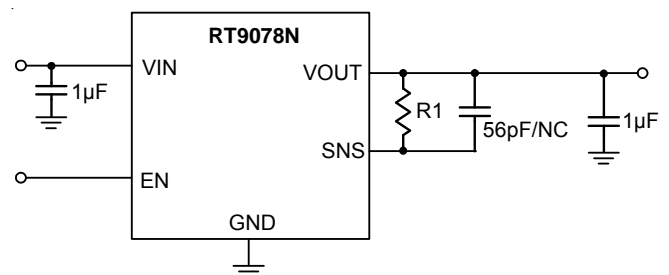

Figure 5. Fine Adjustable Output Voltage Application Circuit

There isn't extra current consumption in the above application. But the temperature coefficient of output voltage will be degraded by the input current at SNS pin. If the tuning range is larger than 50mV, a compensation capacitor (56pF) is required to keep the stability of output voltage. The fine adjustable output voltage is calculated using the formula given in equation 2 :

$$V_{OUT} = V_{SNS} + I_{SNS} \times R1 \tag{2}$$

where I_{SNS} is the input Current at SNS pin (typical 550nA at room temperature) and V_{SNS} is determined by the output voltage selections in the ordering information of RT9078N.

Current Limit

The RT9078 contains an independent current limiter, which monitors and controls the pass transistor's gate voltage, limiting the output current to 0.6A (typ.). The current limiting level is reduced to around 0.3A named fold-back current limit when the output voltage is further decreased. The output can be shorted to ground indefinitely without damaging the part.

Thermal Considerations

For continuous operation, do not exceed absolute maximum junction temperature. The maximum power dissipation depends on the thermal resistance of the IC package, PCB layout, rate of surrounding airflow, and difference between junction and ambient temperature. The maximum power dissipation can be calculated by the following formula :

$$P_{D(MAX)} = (T_{J(MAX)} - T_A) / \theta_{JA}$$

where $T_{J(MAX)}$ is the maximum junction temperature, T_A is the ambient temperature, and θ_{JA} is the junction to ambient thermal resistance.

For recommended operating condition specifications the maximum junction temperature is 125°C and T_A is the ambient temperature. The junction to ambient thermal resistance, θ_{JA} , is layout dependent. For TSOT-23-5 package, the thermal resistance, θ_{JA} , is 230.6°C/W on a standard JEDEC 51-7 four-layer thermal test board. For ZQFN-4L 1x1 (ZDFN-4L 1x1) package, the thermal resistance, θ_{JA} , is 226°C/W on a two-layer Richtek evaluation board. The maximum power dissipation at $T_A = 25^\circ\text{C}$ can be calculated by the following formula :

$$P_{D(MAX)} = (125^\circ\text{C} - 25^\circ\text{C}) / (230.6^\circ\text{C/W}) = 0.43\text{W for TSOT-23-5 package}$$

$$P_{D(MAX)} = (125^\circ\text{C} - 25^\circ\text{C}) / (226^\circ\text{C/W}) = 0.44\text{W for ZQFN-4L 1x1 (ZDFN-4L 1x1) package}$$

The maximum power dissipation depends on the operating

ambient temperature for fixed $T_{J(MAX)}$ and thermal resistance, θ_{JA} . The derating curve in Figure 6 allows the designer to see the effect of rising ambient temperature on the maximum power dissipation.

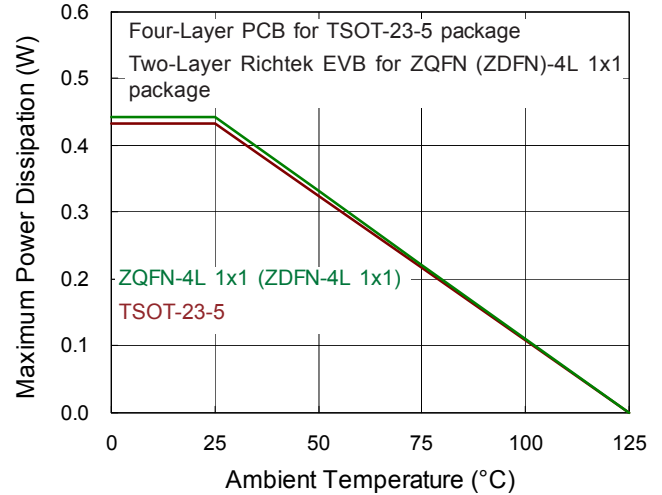

Figure 6. Derating Curve of Maximum Power Dissipation

Layout Consideration

For best performance of the RT9078, the PCB layout suggestions below are highly recommend. All circuit components placed on the same side and as near to the respective LDO pin as possible, place the ground return path connection to the input and output capacitor. Using vias and long power traces for the input and output capacitors connection is discouraged and have negatively affects on performance. Figure 7 and Figure 8 shows the examples for the layout reference that reduce conduction trace loop, helping inductive parasitic minimize, load transient reduction and good circuit stability.

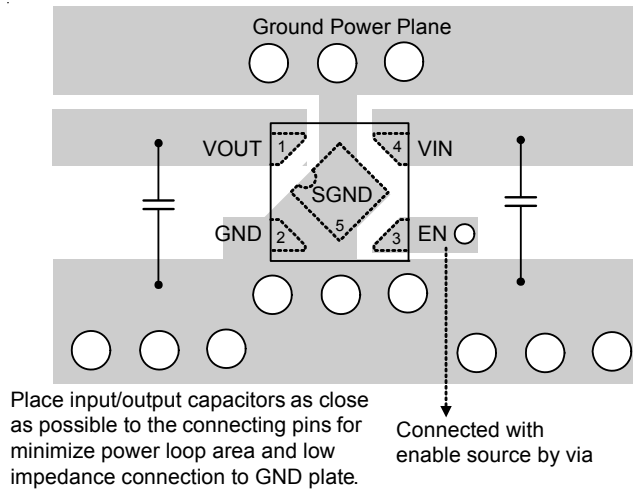

Figure 7. PCB Layout Guide for ZQFN-4L 1x1 package

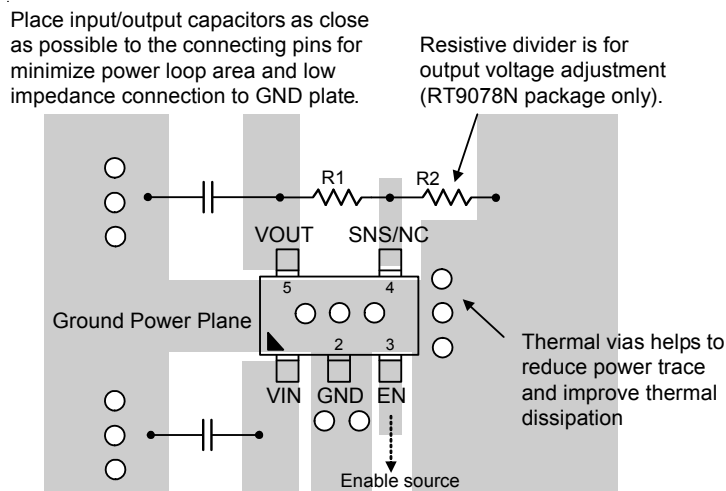
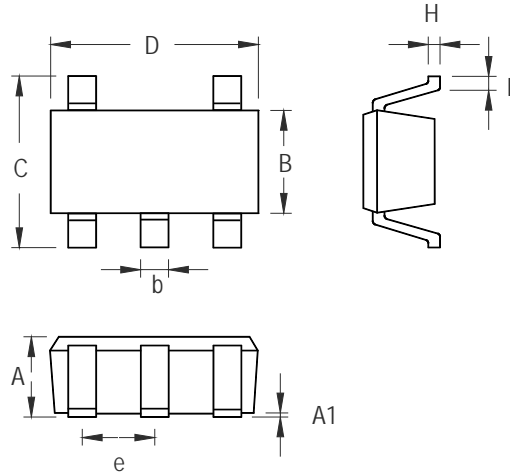

Figure 8. PCB Layout Guide for TSOT-23-5 package

Outline Dimension



Symbol	Dimensions In Millimeters		Dimensions In Inches	
	Min	Max	Min	Max
A	0.700	1.000	0.028	0.039
A1	0.000	0.100	0.000	0.004
B	1.397	1.803	0.055	0.071
b	0.300	0.559	0.012	0.022
C	2.591	3.000	0.102	0.118
D	2.692	3.099	0.106	0.122
e	0.838	1.041	0.033	0.041
H	0.080	0.254	0.003	0.010
L	0.300	0.610	0.012	0.024

TSOT-23-5 Surface Mount Package

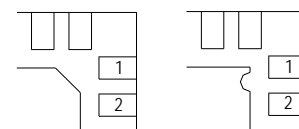
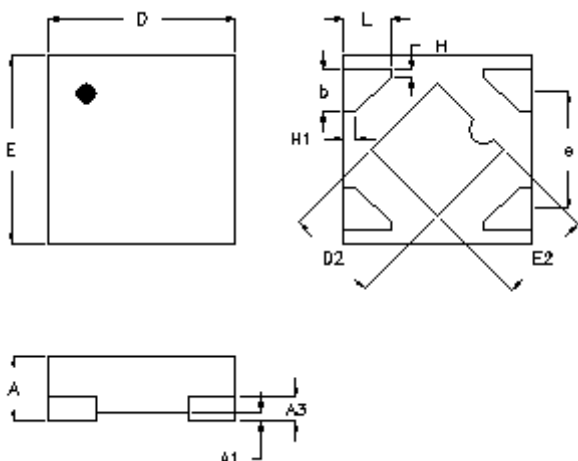

DETAIL A

Pin #1 ID and Tie Bar Mark Options

Note : The configuration of the Pin #1 identifier is optional, but must be located within the zone indicated.

Symbol	Dimensions In Millimeters		Dimensions In Inches	
	Min	Max	Min	Max
A	0.300	0.400	0.012	0.016
A1	0.000	0.050	0.000	0.002
A3	0.117	0.162	0.005	0.006
b	0.175	0.275	0.007	0.011
D	0.900	1.100	0.035	0.043
D2	0.450	0.550	0.018	0.022
E	0.900	1.100	0.035	0.043
E2	0.450	0.550	0.018	0.022
e	0.625		0.025	
L	0.200	0.300	0.008	0.012
H	0.039		0.002	
H1	0.064		0.003	

Z-Type 4L QFN 1x1 Package

Richtek Technology Corporation

14F, No. 8, Tai Yuen 1st Street, Chupei City
 Hsinchu, Taiwan, R.O.C.
 Tel: (8863)5526789

Richtek products are sold by description only. Customers should obtain the latest relevant information and data sheets before placing orders and should verify that such information is current and complete. Richtek cannot assume responsibility for use of any circuitry other than circuitry entirely embodied in a Richtek product. Information furnished by Richtek is believed to be accurate and reliable. However, no responsibility is assumed by Richtek or its subsidiaries for its use; nor for any infringements of patents or other rights of third parties which may result from its use. No license is granted by implication or otherwise under any patent or patent rights of Richtek or its subsidiaries.