

Standalone Linear Li-Ion Battery Charger with Thermal Regulation

■ General Description

The XT2055 is a complete constant-current /constant-voltage linear charger for single cell lithium-ion batteries. Its Thin SOT package and low external component count make the XT2055 ideally suited for portable applications. Furthermore, the XT2055 is specifically designed to work within USB power specifications.

No external sense resistor is needed, and no blocking diode is required due to the internal MOSFET architecture. Thermal feedback regulates the charge current to limit the die temperature during high power operation or high ambient temperature. The charge voltage is fixed at 4.2V, and the charge current can be programmed externally with a single resistor. The XT2055 automatically terminates the charge cycle when the charge current drops to 1/10th the programmed value after the final float voltage is reached.

When the input supply (wall adapter or USB supply) is removed, the XT2055 automatically enters a low current state, dropping the battery drain current to less than 2 μ A. The XT2055 can be put into shutdown mode, reducing the supply current to 25 μ A.

Other features include charge current monitor, under-voltage lockout, automatic recharge and a status pin to indicate charge termination and the presence of an input voltage.

■ Applications

- Cellular Telephones, PDAs, MP3 Players
- Bluetooth Applications

■ Features

- Programmable charge current up to 500mA
- No MOSFET, sense resistor or blocking diode required
- Complete linear charger in thinsot package for single cell lithium-ion batteries
- Constant-current/constant-voltage operation with thermal regulation to maximize charge rate without risk of overheating
- Charges single cell li-ion batteries directly from USB port
- Preset 4.2V charge voltage with $\pm 1\%$ accuracy
- Charge current monitor output for gas gauging
- Charge status output pin
- C/10 charge termination
- 25 μ A supply current in shutdown
- 2.9V trickle charge threshold (XT2055)
- Soft-start limits inrush current
- Available in 6-Lead SOT-23

■ Package

- SOT-23-6L

■ Typical Application Circuit

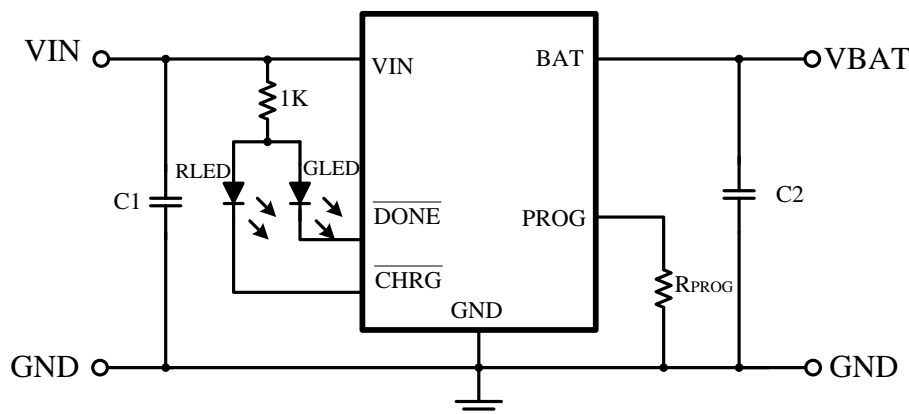

注: $C1=4.7\mu F$, $C2=10\mu F$, $IBAT = (V_{PROG}/R_{PROG}) \times 1000$

Ordering Information

XT2055 ①②③④⑤⑥

Designator	Description	Symbol	Description
①	Type	X	Without trickle charge
		Y	With trickle charge
②③	The first part of regulator Output Voltage	0	4.0
		1	4.1
		2	4.2
④	The second part of regulator Output Voltage	A	00
		B	25
		C	50
		D	75
⑤	Packaging Types	M	SOT-23-6L
⑥	Device Orientation	R	Embossed tape: Standard feed
		L	Embossed tape: Reverse feed

Pin Configuration

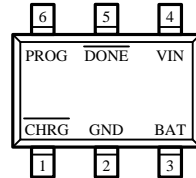
 SOT-23-6L
(TOP VIEW)

Pin Assignment

Pin Number	Pin Name
SOT-23-6L	
1	\overline{CHRG}
2	GND
3	BAT
4	VIN
5	\overline{DONE}
6	PROG

■ Pin Function

CHRG (Pin 1): Open-Drain Charge Status Output. When the battery is charging, the CHRG pin is pulled low by an internal N-channel MOSFET. When the charge cycle is completed, a weak pull-down of approximately 20µA is connected to the CHRG pin, indicating an “AC present” condition. When the XT2055 detects an under voltage lockout condition, CHRG is forced high impedance.

GND (Pin 2): Ground.

BAT (Pin 3): Charge current output. Provides charge current to the battery and regulates the final float voltage to 4.2V. An internal precision resistor divider from this pin sets the float voltage which is disconnected in shutdown mode.

VCC (Pin 4): Positive input supply voltage. Provides power to the charger. VCC should be bypassed with at least a 1µF capacitor. When VCC drops to within 30mV of the BAT pin voltage, the XT2055 enters shutdown mode, dropping IBAT to less than 2µA.

DONE (Pin5): Full indication output, when fully charged, DONE port is an internal N-channel MOSFET placed in low position. In the charging process, low-power lock condition is detected; the input is too high to detect locking conditions, DONE-Z state.

PROG (Pin 5): Charge current program, charge current monitor and shutdown pin. The charge current is programmed by connecting a 1% resistor, RPROG to ground. When charging in constant-current mode, this pin serves to 1V. In all modes, the voltage on this pin can be used to measure the charge current using the following formula:

$$IBAT = (VPROG/RPROG) \times 1000$$

The PROG pin can also be used to shut down the charger. Disconnecting the program resistor from ground allows a 3µA current to pull the PROG pin high. When it reaches the 1.21V shutdown threshold voltage, the charger enters shutdown mode, charging stops and the input supply current drops to 25µA. This pin is also clamped to approximately 2.4V. Driving this pin to voltages beyond the clamp voltage will draw currents as high as 1.5mA. Reconnecting RPROG to ground will return the charger to normal operation.

■ Marking Rule

- SOT-23-6L

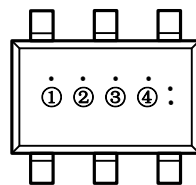

SOT-23-6L
(TOP VIEW)

- ① Represents the product name

Symbol	Product Name
2	XT2055◆◆◆◆◆

② Represents the type of the trickle charge voltage and CHRГ pin

Symbol	Product Series	Description
C	XT2055X◆◆◆◆	Without trickle charge
D	XT2055Y◆◆◆◆	With trickle charge

③ Represents the regulator output voltage

Symbol	Voltage
A	4.0
B	4.025
C	4.05
D	4.075
E	4.1
F	4.125

Symbol	Voltage
H	4.150
K	4.175
L	4.2
M	4.225
N	4.250
P	4.275

④ Represents the assembly lot No.

0-9, A-Z; 0-9, A-Z mirror writing, repeated (G, I, J, O, Q, W exception)

■ Absolute Maximum Ratings

Parameter	Symbol	Maximum Rating	Unit
Input Supply Voltage	V_{cc}	$V_{SS}-0.3 \sim V_{SS}+10$	V
PROG pin Voltage	V_{prog}	$V_{SS}-0.3 \sim V_{cc}+0.3$	
BAT pin Voltage	V_{bat}	$V_{SS}-0.3 \sim 7$	
CHAG pin Voltage	V_{chrg}	$V_{SS}-0.3 \sim V_{SS}+10$	
Power Dissipation	P_D	SOT-23-6L 250	mW
BAT pin Current	I_{bat}	500	mA
PROG pin Current	I_{prog}	800	μA
Operating Ambient Temperature	T_{opa}	-40~+85	$^{\circ}C$
Storage Temperature	T_{str}	-65~+125	

Caution: The absolute maximum ratings are rated values exceeding which the product could suffer physical damage. These values must therefore not be exceeded under any conditions.

■ Block Diagram

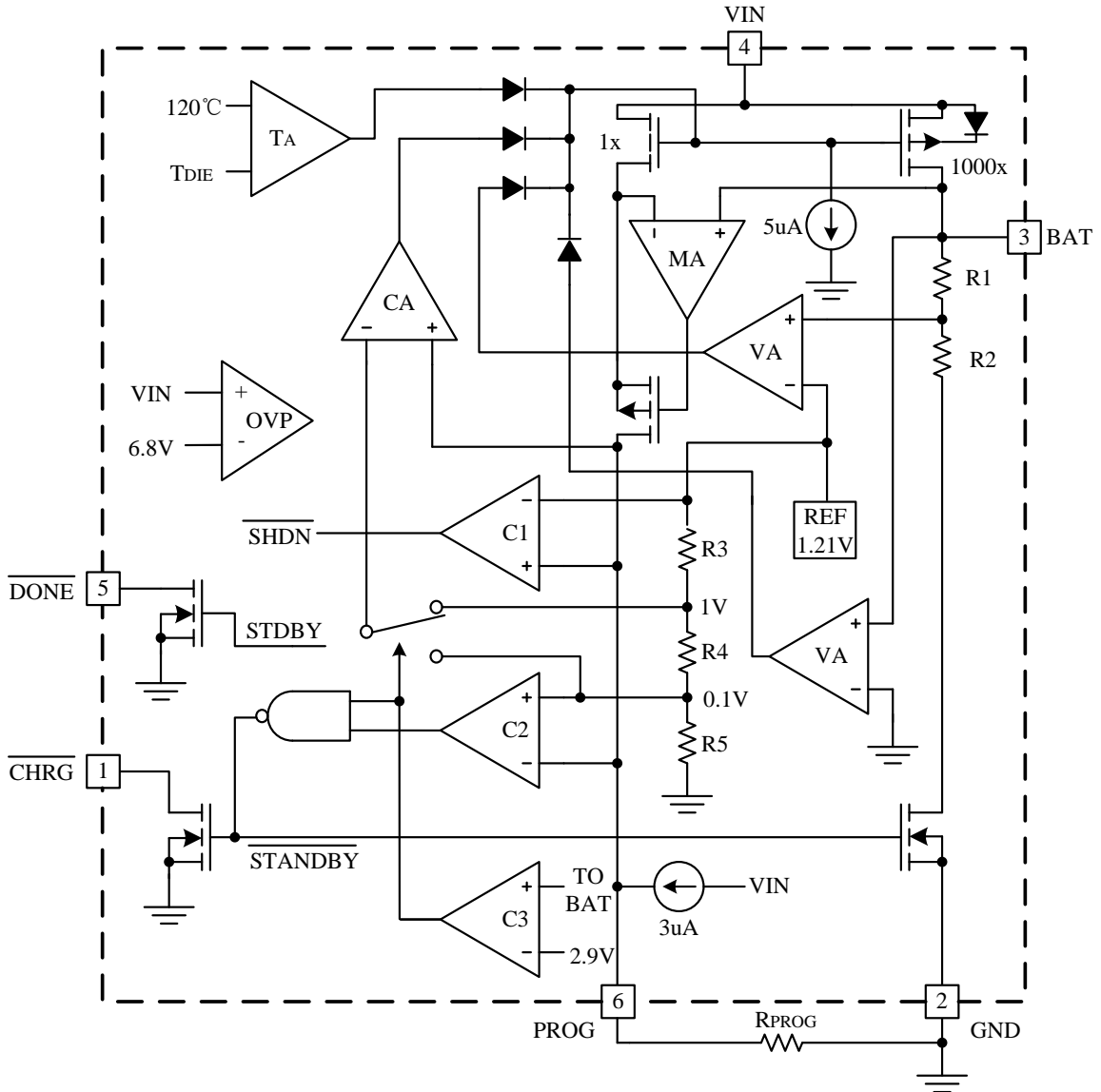

■ Electrical Characteristics

Parameter	Symbol	Condition	Min	Typ	Max	Unit
Input supply voltage	Vcc		4.25		6.5	V
Input supply current	Icc	Charge mode, Rprog=10K		300	2000	μA
		Standby mode		200	500	μA
		Shutdown mode(Rprog not connected, Vcc<Vbat or Vcc<Vuv)		25	50	μA
Regulated Output Voltage	Vfloat	0°C<TA<85°C, IBAT=40mA	4.158	4.2	4.242	V
BAT pin Current	Ibat	Rprog=10k, Current mode	93	100	107	mA
		Rprog=2k, Current mode	465	500	535	mA
		Standby mode, Vbat=4.2V	0	-2.5	-6	μA
		Shutdown mode		1	2	μA
		Sleep mode, Vcc=0V		1	2	μA
Trickle charge current	Itrikl	Vbat<Vtrikl, Rprog=2k	93	100	107	mA
Trickle charge Threshold Voltage	Vtrikl	Rprog=10K, Vbat Rising	2.8	2.9	3.0	V
Trickle voltage hysteresis voltage	Vtrhys	Rprog=10k	60	80	110	mV
Vcc Undervoltage lockout Threshold	Vuv	From Vcc low to high	3.7	3.8	3.93	V
Vcc undervoltage lockout hysteresis	Vuvhys		150	200	300	mV
Manual shutdown threshold voltage	Vmsd	PROG pin rising	1.15	1.21	1.30	V
		PROG pin falling	0.9	1.0	1.1	V
Vcc-Vbat Lockout Threshold voltage	Vasd	Vcc from low to high	70	100	140	mV
		Vcc from high to low	5	30	50	mV
C/10 Termination Current Threshold	Iterm	Rprog=10k	0.085	0.10	0.115	mA/mA
		Rprog=2k	0.085	0.10	0.115	mA/mA
PROG pin Voltage	Vprog	Rprog=10k, Current mode	0.93	1.0	1.07	V
CHRG pin weak pull-down Current	Ichrg	Vchrg=5V	8	20	35	μA
CHRG pin Output low voltage	Vchrg	Ichrg=5mA		0.35	0.6	V
Recharge Battery threshold Voltage	ΔVrecg	VFLOAT - VRECHRG		100	200	mV

Typical Performance Characteristics

1. Charge Current VS Battery Voltage

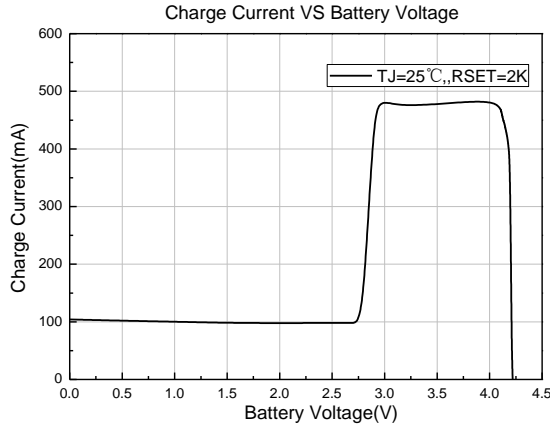

2. Charge Current VS PROG Pin Voltage

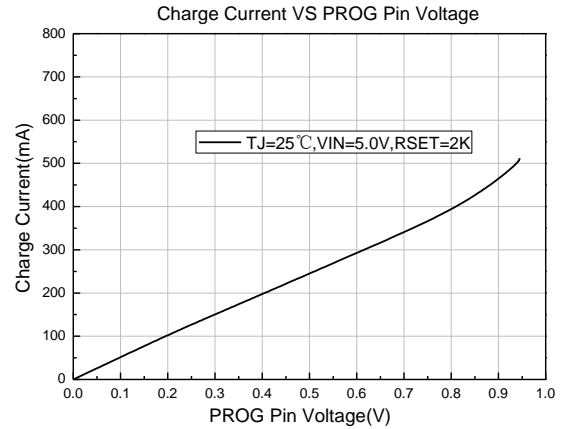

3. Charge Current VS Supply Voltage

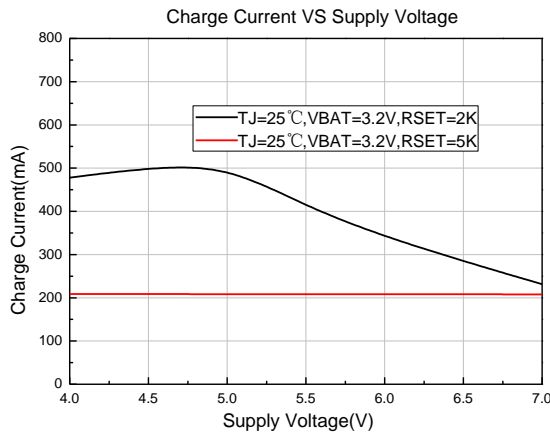

4. PROG Pin Pull-up Current VS PROG Pin Voltage

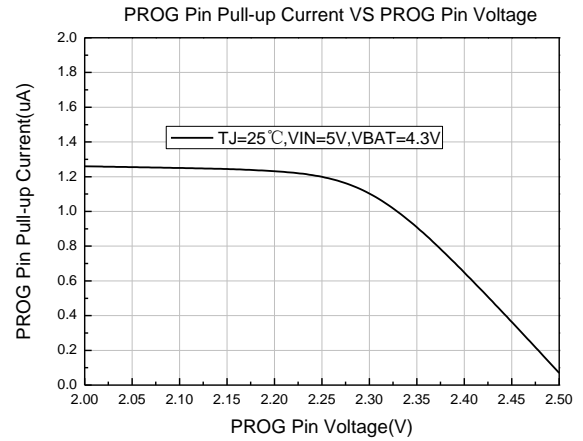

5. Charge Pin Current VS Charge Voltage (Weak Pull-Down State)

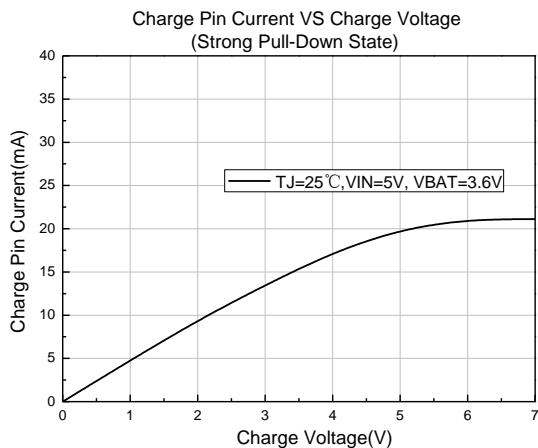

6. Charge Pin Current VS Charge Voltage (Strong Pull-Down State)

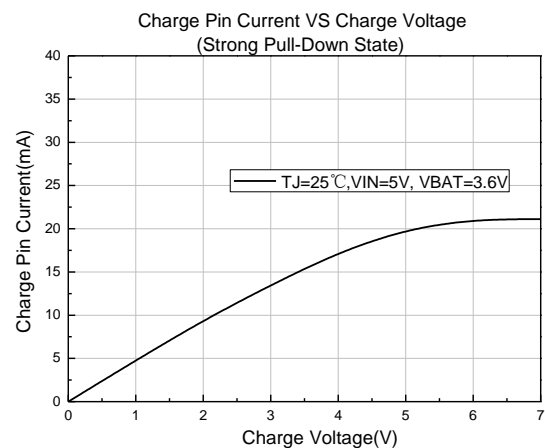

7. PROG Pin Voltage VS Supply Voltage

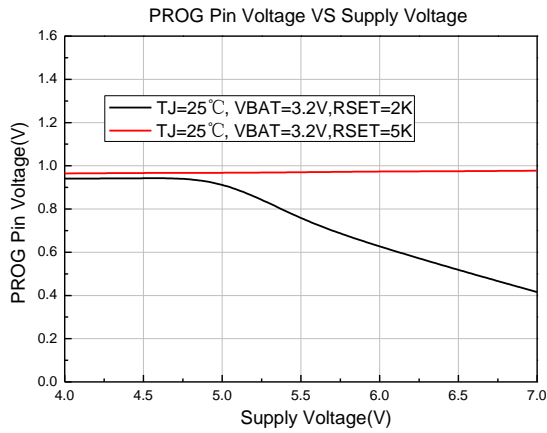

8. Trickle Charge Current VS Supply Voltage

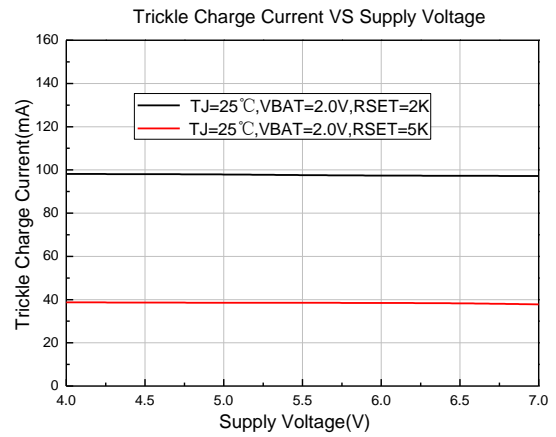

9. Regulated Output (Float) Voltage VS Supply Voltage

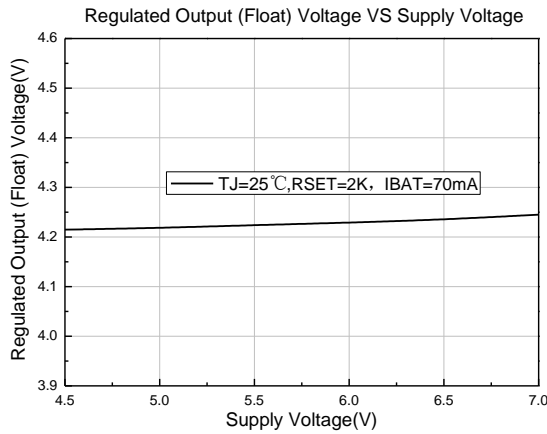

10. PROG Pin Voltage VS Temperature

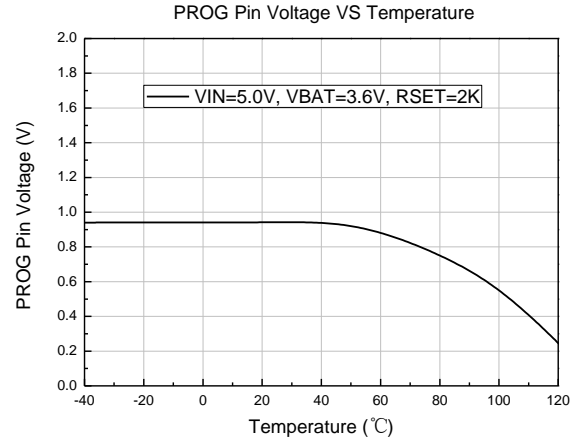

11. PROG Pin Pull-up Current VS Temperature

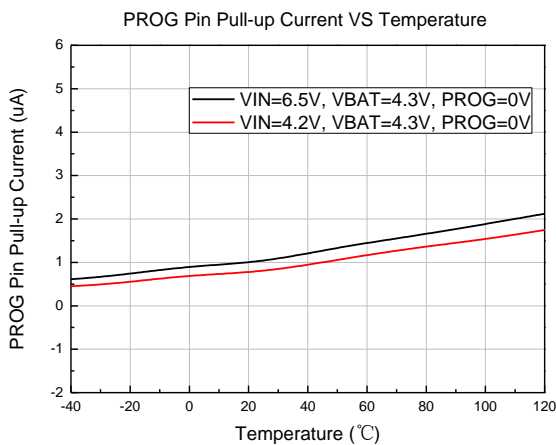

12. VBAT VS Temperature

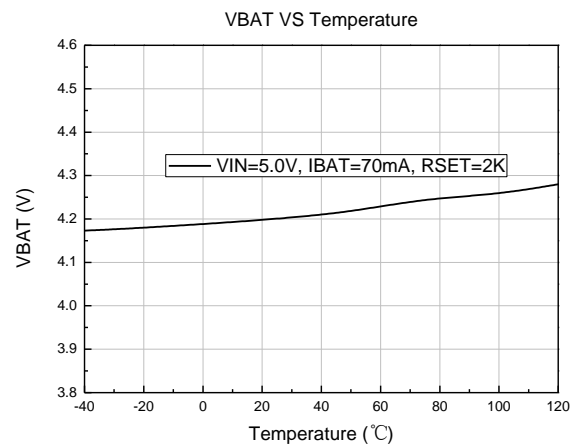

13. Recharge Battery threshold Voltage VS Temperature

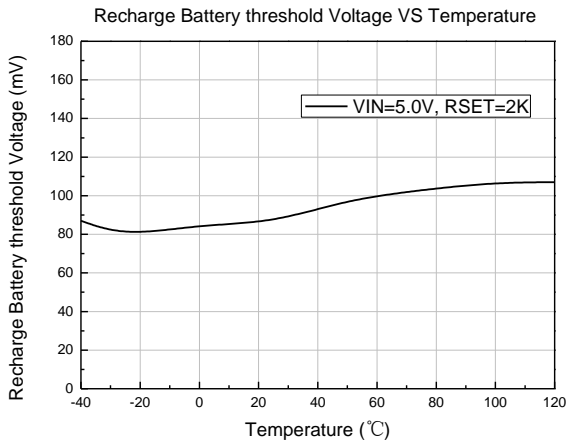

14. Charge Pin Current VS Temperature

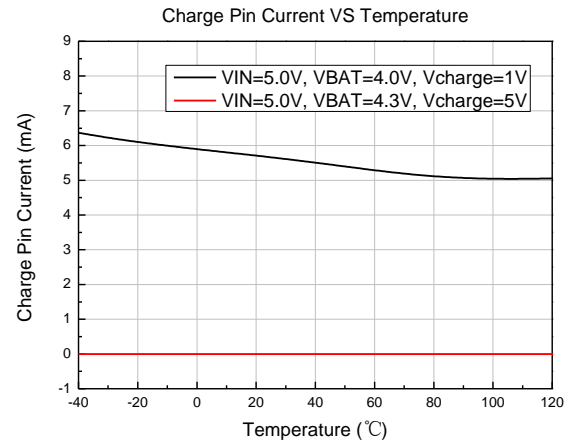

15. Trickle Charge Current VS Temperature

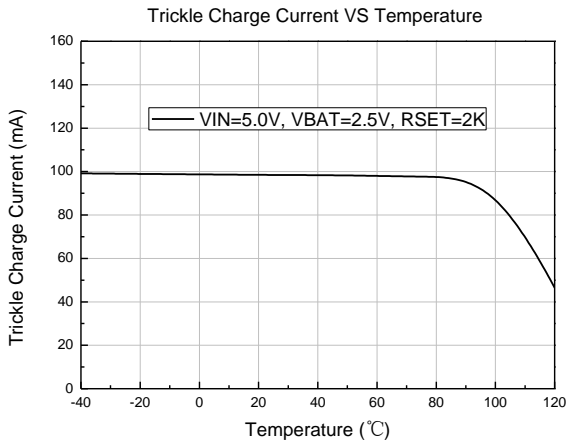

16. Trickle charge Threshold Voltage VS Temperature

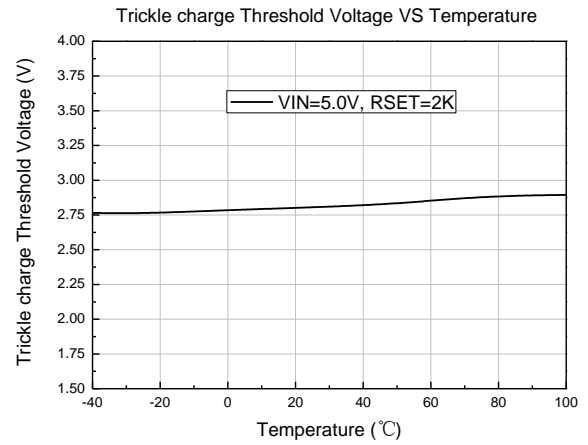

17. Charge Current VS Temperature

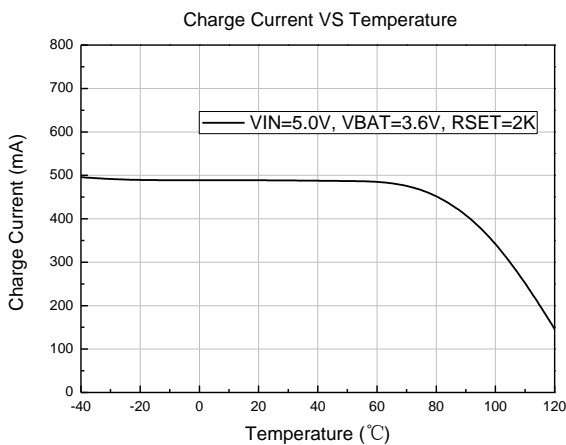

18. Power Tube Resistance VS Temperature

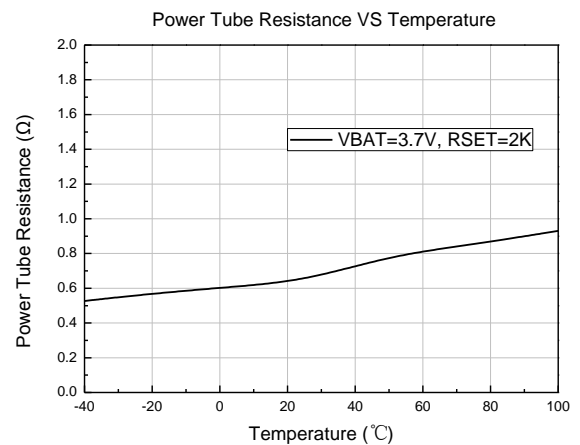

■ Package Information

- SOT-23-6L

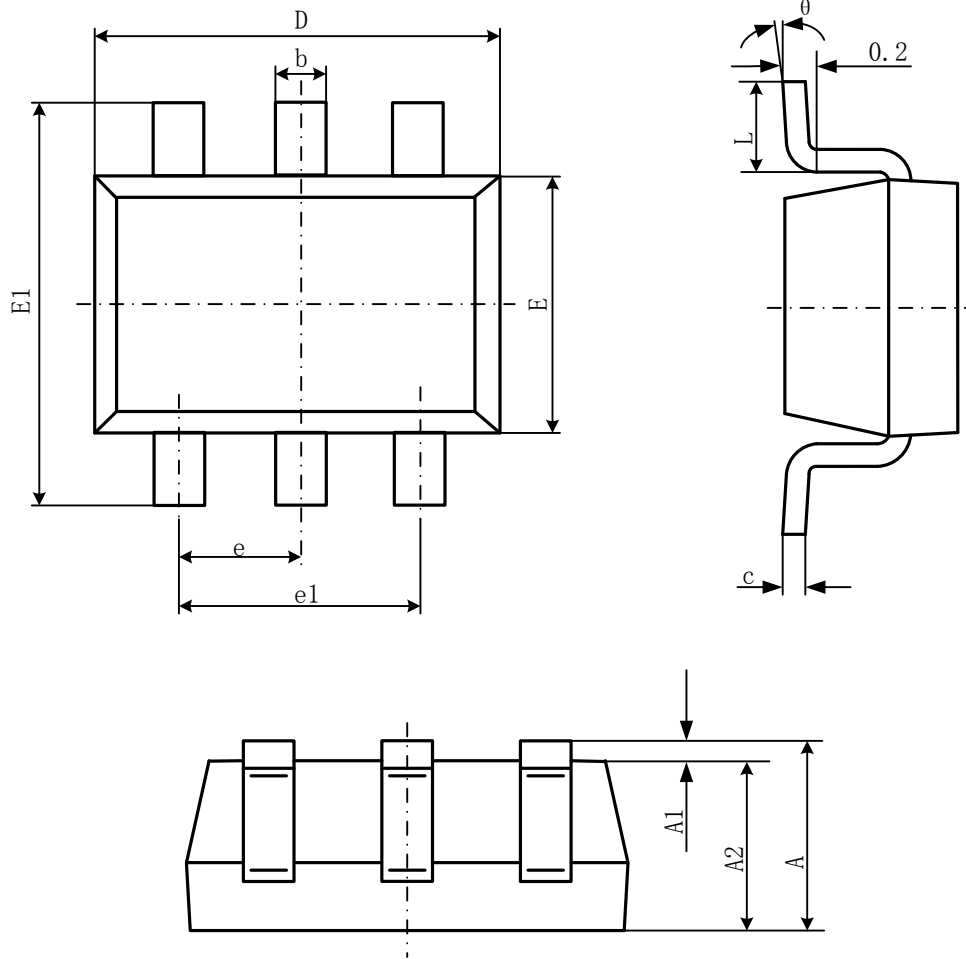

Symbol	Dimensions In Millimeters		Dimensions In Inches	
	Min	Max	Min	Max
A	1.050	1.250	0.041	0.049
A1	0.000	0.100	0.000	0.004
A2	1.050	1.150	0.041	0.045
b	0.300	0.500	0.012	0.020
c	0.100	0.200	0.004	0.008
D	2.820	3.020	0.111	0.119
E	1.500	1.700	0.059	0.067
E1	2.650	2.950	0.104	0.116
e	0.950(BSC)		0.037(BSC)	
e1	1.800	2.000	0.071	0.079
L	0.300	0.600	0.012	0.024
θ	0°	8°	0°	8°