

3W, wide input isolated & regulated
DC-DC converter



Patent Protection **RoHS**

FEATURES

- Wide range of input voltage (2:1)
- DIP package
- Efficiency up to 86%
- 1.5KVDC isolation
- Short circuit protection (automatic recovery)
- Operating temperature range: -40°C ~ +85°C
- Meet CISPR22/EN55022 CLASS A
- Meet EN60950

The WRA_ZP-3WR2 & WRB_ZP-3WR2 Series are specially designed for applications where a wide range input voltage power supplies are isolated from the input power supply in a distributed power supply system on a circuit board. For these DC-DC converters, you can reduce the failure points of design, and save the manpower, material and time cost in developing micro power supply, and also ensure better quality, stability, safety protection, and reliability for the end products.

These products apply to where:

- 1) Input voltage range $\leq 2:1$;
- 2) 1.5KVDC input and output isolation;
- 3) Output regulated and low ripple noise is required.

In circuits such as industrial control, electric power, communication system power supply, etc.

Selection Guide

Part No.	Input Voltage (VDC)		Output		Efficiency (% Typ.) @ Full Load	Max. Capacitive Load ^② (μ F)	certification
	Nominal (Range)	Max. ^①	Output Voltage (VDC)	Output Current (mA) (Max./Min.)			
WRA0505ZP-3WR2	5 (4.5-9)	11	± 5	$\pm 300/\pm 15$	76	2200	
WRA0512ZP-3WR2			± 12	$\pm 125/\pm 6$	78	1800	
WRA0515ZP-3WR2			± 15	$\pm 100/\pm 5$	78	1000	
WRB0505ZP-3WR2			5	600/30	74	4700	
WRB0512ZP-3WR2			12	250/12	77	2700	
WRB0515ZP-3WR2			15	200/10	77	2200	
WRA1205ZP-3WR2	12 (9-18)	20	± 5	$\pm 300/\pm 15$	81	2200	--
WRA1209ZP-3WR2			± 9	$\pm 166/\pm 8$	84	2000	
WRA1212ZP-3WR2			± 12	$\pm 125/\pm 6$	84	1800	
WRA1215ZP-3WR2			± 15	$\pm 100/\pm 5$	85	1000	
WRB1203ZP-3WR2			3.3	909/46	74	4700	
WRB1205ZP-3WR2			5	600/30	81	4700	
WRB1212ZP-3WR2			12	250/12	83	2700	
WRB1215ZP-3WR2			15	200/10	82	2200	
WRB1224ZP-3WR2			24	125/6	83	1800	
WRA2405ZP-3WR2			24 (18-36)	40	± 5	$\pm 300/\pm 15$	
WRA2412ZP-3WR2	± 12	$\pm 125/\pm 6$			84	1800	
WRA2415ZP-3WR2	± 15	$\pm 100/\pm 5$			84	1000	
WRB2403ZP-3WR2	3.3	909/46			78	4700	
WRB2405ZP-3WR2	5	600/30			81	4700	
WRB2412ZP-3WR2	12	250/12			86	2700	
WRB2415ZP-3WR2	15	200/10			86	2200	
WRB2415ZP-3WR2							--

PowerPax UK Ltd

Unit 5 Kennet Weir Business Park, Arrowhead Road, Theale, Berkshire, RG7 4AD, United Kingdom

Tel: +44 (0) 118 9033290 Fax: +44 (0) 118 9033291

info@powerpaxuk.com Website: www.mornsun.co.uk

WRB2424ZP-3WR2			24	125/6	85	1800	
WRA4805ZP-3WR2	48 (36-75)	80	±5	±300/±15	82	2200	--
WRA4812ZP-3WR2			±12	±125/±6	84	1800	
WRA4815ZP-3WR2			±15	±100/±5	85	1000	
WRB4803ZP-3WR2			3.3	909/46	76	4700	
WRB4805ZP-3WR2			5	600/30	82	4700	
WRB4812ZP-3WR2			12	250/12	86	2700	
WRB4815ZP-3WR2			15	200/10	86	2200	

Note:

① Absolute maximum rating without damage on the converter, but it isn't recommended;

② For dual output converter, the given value is the same for each output.

Input Specifications

Item	Operating Conditions	Min.	Typ.	Max.	Unit
Input Current (full load /no-load)	5VDC input	--	811/40	--	mA
	12VDC input		309/30		
	24VDC input		155/15		
	48VDC input		77/5		
Reflected Ripple Current	5VDC input	--	20	--	
	12VDC input		30		
	24VDC input		30		
	48VDC input		30		
Input impulse Voltage (1sec. max.)	5VDC input	-0.7	--	12	VDC
	12VDC input		--	25	
	24VDC input		--	50	
	48VDC input		--	100	
Starting Voltage	5VDC input	--	--	4.5	
	12VDC input	--	--	9	
	24VDC input	--	--	18	
	48VDC input	--	--	36	
Input Filter		Pi filter			

Output Specifications

Item	Operating Conditions	Min.	Typ.	Max.	Unit
Output Voltage Accuracy		--	±1	±3	%
No load output Voltage Accuracy	Input voltage range	--	±1.5	±5	
Balance of Output Voltage	Dual output, balanced load	--	±0.5	±1	
Linear Regulation	Full load, the input voltage is from low voltage to high voltage	--	±0.2	±0.5	
Load Regulation	5%-100% load	--	±0.2	±0.5	
Transient Recovery Time	25% load step change	--	0.5	2	ms
Transient Response Deviation		--	±2	±5	%
Temperature Coefficient	Full load	--	±0.02	±0.03	%/°C
Ripple&Noise*	20MHz bandwidth	--	50	80	mV p-p
Short circuit Protection	Input voltage range	Continuous, self-recovery			

Note: * Ripple and noise are measured by "parallel cable" method, please see DC-DC Converter Application Notes for specific operation.

General Specifications

Item	Operating Conditions	Min.	Typ.	Max.	Unit
Insulation Voltage	Input-output, with the test time of 1 minute and the leak current lower than 1mA	1500	--	--	VDC

PowerPax UK Ltd

Unit 5 Kennet Weir Business Park, Arrowhead Road, Theale, Berkshire, RG7 4AD, United Kingdom

Tel: +44 (0) 118 9033290 Fax: +44 (0) 118 9033291

info@powerpaxuk.com Website: www.mornsun.co.uk

Insulation Resistance	Input-output, isolation voltage 500VDC	1000	--	--	MΩ
Isolation Capacitance	Input-output, 100KHz/0.1V	--	120	--	pF
Operating Temperature	Derating if the temperature is $\geq 85^{\circ}\text{C}$ (see Fig. 1)	-40	--	85	°C
Storage Temperature		-55	--	125	
Casing Temperature Rise	Ta=25°C	--	25	--	
Hand Soldering	Welding spot is 1.5mm away from the casing, 10 seconds	--	--	300	
Storage Humidity	Non-condensing	--	--	95	%
Switching Frequency(PFM mode)	100% load, nominal input voltage	--	200	--	KHz
MTBF	MIL-HDBK-217F@25°C	1000	--	--	K hours

Physical Specifications

Casing Material	Aluminum Alloy
Dimensions	32.00*20.00*10.80 mm
Weight	14g(Typ.)
Cooling	Free convection

EMC Specifications

EMI	Conducted emission	CISPR22/EN55022 CLASS A(Bare component) CLASS B (see Fig.3-② for recommended circuit)			
	Radiated emission	CISPR22/EN55022 CLASS A(Bare component) CLASS B (see Fig.3-② for recommended circuit)			
EMS	Electrostatic discharge	IEC/EN61000-4-2	Contact $\pm 4\text{KV}$ / Air $\pm 8\text{KV}$		perf. Criteria B
	Radiation immunity	IEC/EN61000-4-3	10V/m		perf. Criteria A
	EFT	IEC/EN61000-4-4	$\pm 2\text{KV}$ (see Fig.3-① for recommended circuit)		perf. Criteria B
	Surge immunity	IEC/EN61000-4-5	$\pm 2\text{KV}$ (see Fig.3-① for recommended circuit)		perf. Criteria B
	Conducted disturbance immunity	IEC/EN61000-4-6	3 Vr.m.s		perf. Criteria A
	Immunities of voltage dip, drop and short interruption	IEC/EN61000-4-29	0-70%		perf. Criteria B

Product Characteristic Curve

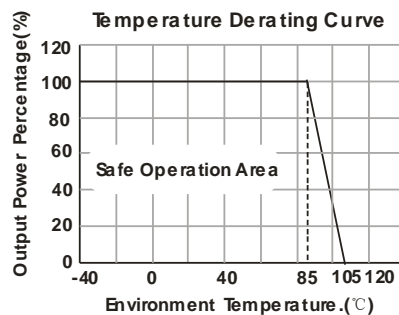
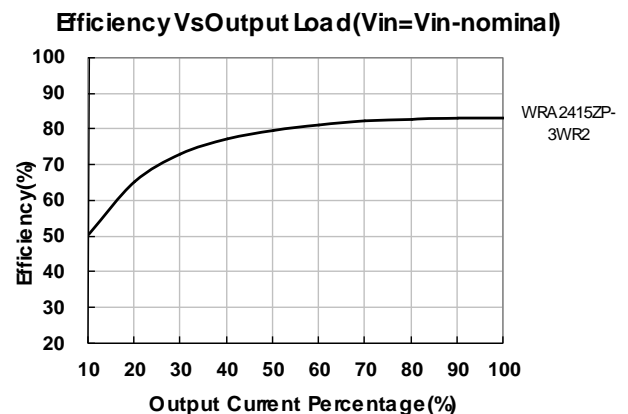
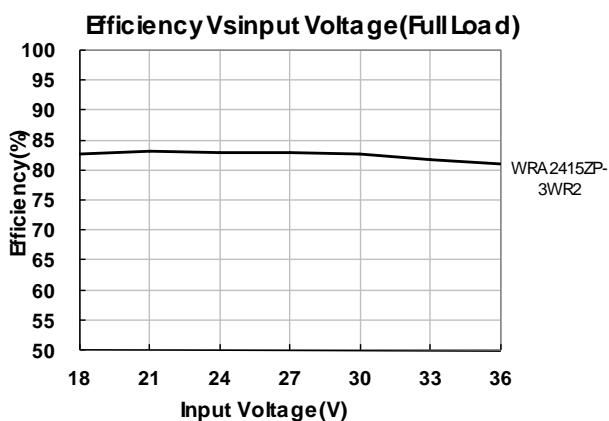
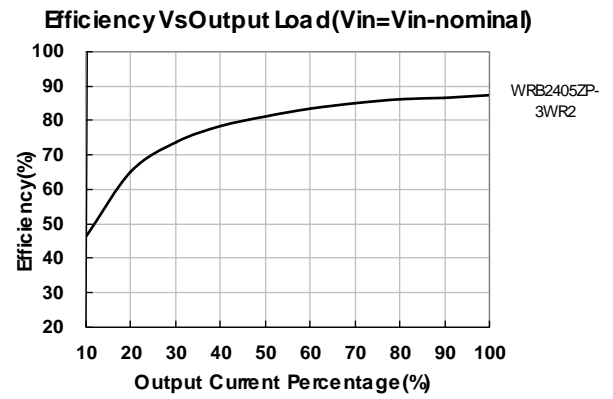
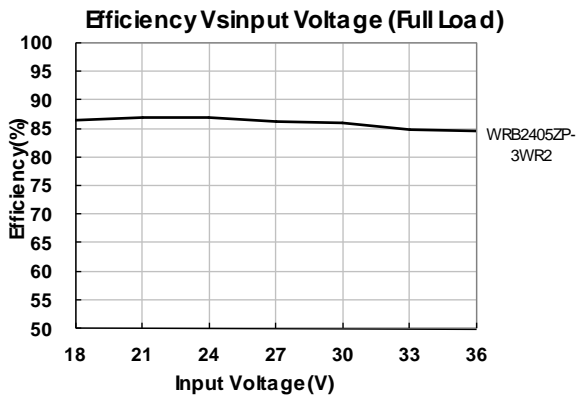

Fig. 1





Design Reference

1. Output load requirements

To ensure that the module can work efficiently and reliably, its output min. load shall be no lower than 5% of the rated load when using, or the output ripple may increase rapidly. Ensure that the product working load must be higher than 5% of the rated load.

2. Typical application

All the DC/DC converters of this series are tested according to the recommended circuit (see Fig. 2) before delivery.

If it is required to further reduce input and output ripple, properly increase the input & output of additional capacitors C_{in} and C_{out} or select capacitors of low equivalent impedance provided that the capacitance is no larger than the max. capacitive load of the product.

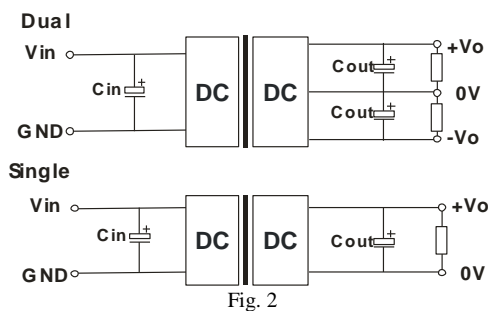

Fig. 2

V_{in}	5V&12V	24V&48V
C_{in}	100 μ F	10 μ F~47 μ F
C_{out}	10 μ F	

3. EMC solution-recommended circuit

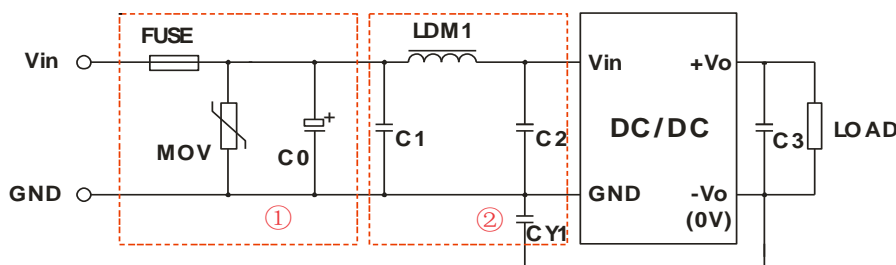

Fig. 3

Parameter description:

Model	Vin:5V	Vin:12V	Vin:24V	Vin:48V
FUSE	Slow blown fuses according to the actual input current selections of the clients			
MOV	--	S14K25	S14K35	S14K60
C0	1000µF	1000µF	330µF/50V	330µF/100V
C1	4.7µF/50V			4.7µF/100V
LDM1	12µH			
C2	4.7µF/50V			4.7µF/100V
C3	10µF			
CY1	1nF/2KV			

Note: ①Part ① in the Fig. 3 is used for EMS test and part ② for EMI filtering, selected based on needs.
②If there is no recommended parameters, the model no require the external component.

EMC solution-recommended circuit PCB layout

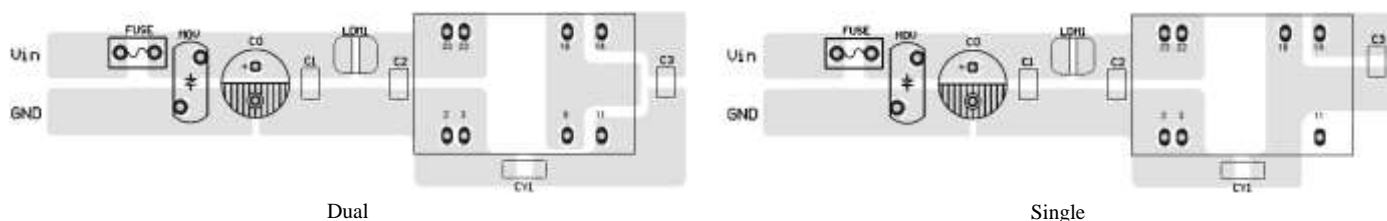

Fig. 4

Note: Note: the min. distance of the bonding pads between input grounding and output grounding shall be $\geq 2\text{mm}$.

4. Input current

When the electricity is provided by the unstable power supply, please make sure that the range of the output voltage fluctuation and the ripple voltage of the power supply do not exceed the indicators of the modules. Input current of power supply should afford the flash startup current of this kind of DC/DC module(see Fig. 5).

Generally: Vin=5V Iave=1400mA
Vin=12V Iave=620mA
Vin=24V Iave=310mA
Vin=48V Iave=150mA

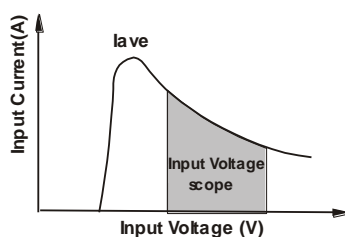

Fig. 5

5. For more information please find DC-DC converter application notes on www.mornsun-power.com

Dimensions and Recommended Layout

PowerPax UK Ltd

Unit 5 Kennet Weir Business Park, Arrowhead Road, Theale, Berkshire, RG7 4AD, United Kingdom

Tel: +44 (0) 118 9033290 Fax: +44 (0) 118 9033291

info@powerpaxuk.com Website: www.mornsun.co.uk

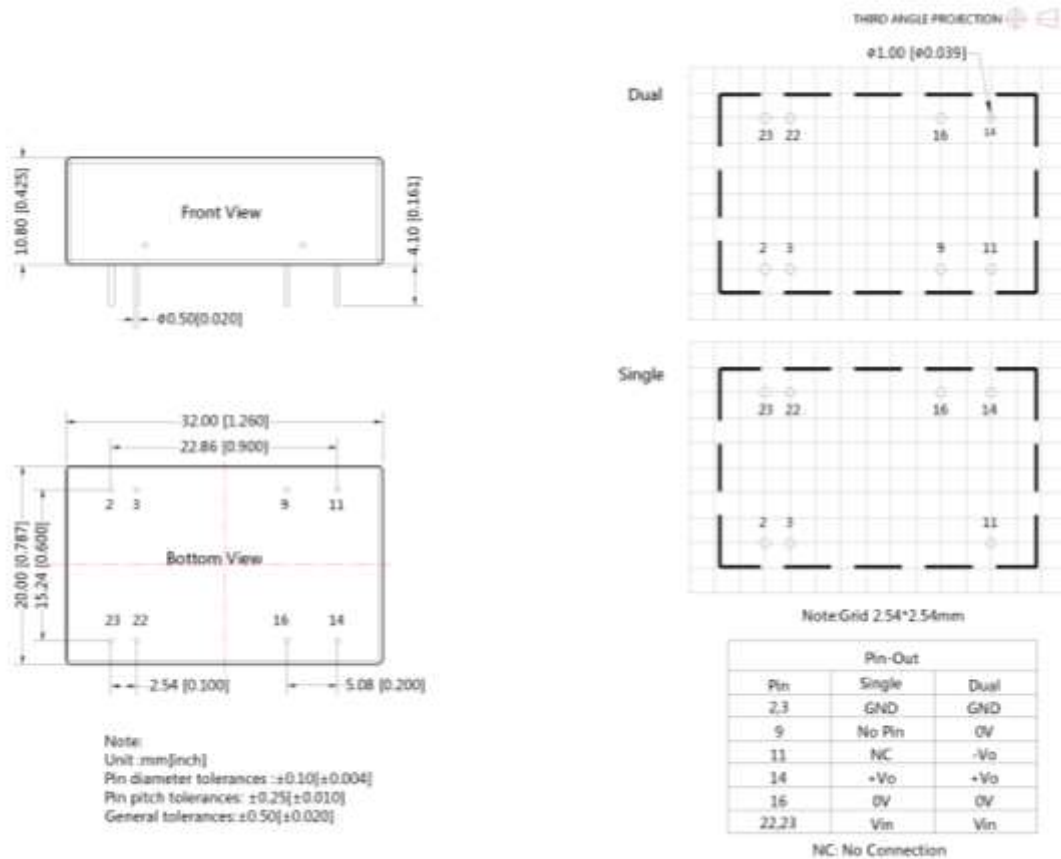

- Note:
1. Packing Information please refer to 'Product Packing Information'. Packing bag number: 58210008;
 2. The min. load shall be no lower than 5%, or the output ripple may increase rapidly; If the product is operated under the min. required load, the product performance cannot be guaranteed to comply with all performance indexes in the Manual, but the reliability of the product will not be influenced;
 3. The unbalance degree of the recommended dual output module load: $\leq 5\%$; if the degree exceeds $\pm 5\%$, then the product performances cannot be guaranteed to comply with all the performance indicators in the manual, and please directly contact our technicians for specific information;
 4. The max. capacitive load should be tested within the input voltage range and under full load conditions;
 5. Unless otherwise specified, data in this datasheet should be tested under the conditions of $T_a=25^\circ\text{C}$, humidity $<75\%$ when inputting nominal voltage and outputting rated load;
 6. All index testing methods in this datasheet are based on our Company's corporate standards;
 7. The performance indexes of the product models listed in this datasheet are as above, but some indexes of non-standard model products will exceed the above-mentioned requirements, and please directly contact our technicians for specific information;
 8. We can provide product customization service;
 9. Specifications of this product are subject to changes without prior notice.