

URA_D-30WR2&URB_D-30WR2 SERIES

30W, 4:1 WIDE INPUT, ISOLATED & REGULATED DUAL/ SINGLE OUTPUT DIP DC-DC CONVERTER



Patent Protected RoHS

PART NUMBER SYSTEM

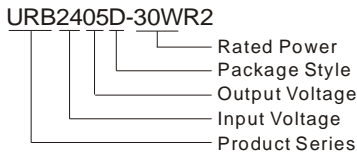

FEATURES

- Efficiency up to 90%
- 4:1 wide input voltage range
- 1500VDC isolation
- Six-sided metal shield
- Short circuit protection (automatic recovery)
- Operating temperature: -40°C to +85°C
- Industry standard pinout
- Meet CISP22/EN55022 CLASS A

APPLICATION

URA_D-30WR2&URB_D-30WR2 series offer 30W of output, wide input voltage:9-36VDC, 18-75VDC, and features 1500VDC isolation, six-sided metal shield, over current and short circuit protection. All models are particularly suitable for industrial, telecommunication, electric power, test equipments applications.

SELECTION GUIDE

Model ①	Input Voltage(VDC)		Output Voltage (VDC)	Output Current (mA)		Input Current (mA)(typ.)		Reflected Ripple Current (mA,typ.)	Max. Capacitive Load ③ (μF)	Efficiency (% , typ.) @Max. Load
	Nominal (Range)	Max ②		Max.	Min.	@Max. Load	@No Load			
URA2405D-30WR2	24 (9-36)	40	±5	±3000	±150	1450	30	30	2000	86
URA2412D-30WR2			±12	±1250	±63	1420			1250	89
URA2415D-30WR2			±15	±1000	±50	1420			680	90
URB2405D-30WR2			5	6000	300	1420	120		6000	88
URB2412D-30WR2			12	2500	125		30		2500	88
URB2415D-30WR2			15	2000	100		30		1100	90
URA4805D-30WR2	48 (18-75)	80	±5	±3000	±150	1450	30	30	2000	86
URA4812D-30WR2			±12	±1250	±63	1420			1250	87
URA4815D-30WR2			±15	±1000	±50	1420			680	87
URB4805D-30WR2			5	6000	300	1420	100		6000	88
URB4812D-30WR2			12	2500	125		30		2500	88
URB4815D-30WR2			15	2000	100		30		1100	89

Note:

- ①. series with suffix "H" are heat sink mounting, for example URB2405D-30WRH2 is with heatsink, URB2405D-30WR2 is without heat sink. If the application has a higher requirement for heat dissipation, you can choose modules with heat sink.
- ②. Absolute maximum rating without damage on the converter, but it isn't recommended.
- ③. For dual output converter, the given value is the same for each output.

INPUT SPECIFICATIONS

Item	Test Conditions	Min.	Typ.	Max.	Unit
Input Surge Voltage (1sec.max.)	24VDC input	-0.7	--	50	VDC
	48VDC input	-0.7	--	100	
Under Voltage Lockout	Nominal Input (24V)	Models ON	--	9	
		Models OFF	7.8	--	
	Nominal Input (48V)	Models ON	--	--	17.8
		Models OFF	16	--	--
Start-up Time		--	10	--	ms

Ctrl*	Models ON	Ctrl leave open or connect TTL high level(2.5-12VDC)			
	Models OFF	Ctrl connect GND or low level(0-1.2VDC)			
	Input current (Models OFF)	--	1	--	mA
Input Filter	Pi Filter				
Note:* The Ctrl pin voltage is referenced to GND.					

OUTPUT SPECIFICATIONS

Item	Test Conditions	Min.	Typ.	Max.	Unit
Output Voltage Accuracy		--	±1	±3	%
Load Regulation	From 5% to 100% load input	--	±0.5	±1	
Voltage Regulation	100% load, Input voltage from low to high	--	±0.2	±0.5	
Cross Regulation	From 10% to 100% load input(Dual Output)	--	--	±5	
Transient Response Deviation	25% load step change	--	±3	±5	
Transient Recovery Time		--	300	500	µs
Temperature Drift	100% load	--	±0.02	--	%/°C
Ripple & Noise*	20MHz Bandwidth	--	85	100	mVp-p
Trim		--	±10%Vo	--	VDC
Over Voltage Protection	5V output	--	6.1	--	
	12V output	--	15	--	
	15V output	--	18	--	
Over Current Protection	Input voltage range	--	150	--	%Io
Short Circuit Protection		Hiccup, continual, auto-recovery			
Note: *Ripple and noise tested by "parallel cable" method. See detailed operation instructions at Testing of Power Converter section, application notes.					

COMMON SPECIFICATIONS

Item	Test Conditions	Min.	Typ.	Max.	Unit
Isolation Voltage	Input-Output, Tested for 1 minute and leakage current than 1 mA	1500	--	--	VDC
Isolation Resistance	Input-Output, Test at 500VDC	1000	--	--	MΩ
Isolation Capacitance	Input-Output, 100KHz/0.1V	--	2000	--	pF
Switching Frequency	PWM mode	--	400	--	KHz
MTBF	MIL-HDBK-217F@25°C	1000	--	--	K hours
Case Material	Aluminum Alloy				
Size	Without heatsink	50.8x40.6x11.8			mm
	With heatsink	50.8x40.6x16.3			
Weight	Without heatsink	--	50	--	g
	With heatsink	--	70	--	

ENVIRONMENTAL SPECIFICATIONS

Item	Test Conditions	Min.	Typ.	Max.	Unit
Storage Humidity	Non condensing	5	--	95	%
Operating Temperature	Power derating (above 60°C, see Figure 3)	-40	--	85	°C
Storage Temperature		-55	--	125	
The Max. Case Temperature	Operating Temperature curve range	--	--	105	
Lead Temperature	1.5mm from case for 10 seconds	--	--	300	
Cooling	Free air convection				

EMC SPECIFICATIONS

EMI	CE	CISPR22/EN55022 CLASS A (Without External Circuit) / CLASS B (External Circuit Refer to Figure1-②)			
	RE	CISPR22/EN55022 CLASS A (Without External Circuit) / CLASS B (External Circuit Refer to Figure1-②)			
EMS	ESD	IEC/EN61000-4-2	Contact ±4KV	perf. Criteria B	
	RS	IEC/EN61000-4-3	10V/m	perf. Criteria A	
	EFT	IEC/EN61000-4-4	±2KV	perf. Criteria B (External Circuit Refer to Figure1-①)	
	Surge	IEC/EN61000-4-5	±2KV	perf. Criteria B (External Circuit Refer to Figure1-①)	
	CS	IEC/EN61000-4-6	3 Vr.m.s	perf. Criteria A	

EMS	Voltage dips, short and interruptions immunity	IEC/EN61000-4-29 0%-70%	perf. Criteria B
-----	--	-------------------------	------------------

EMC RECOMMENDED CIRCUIT

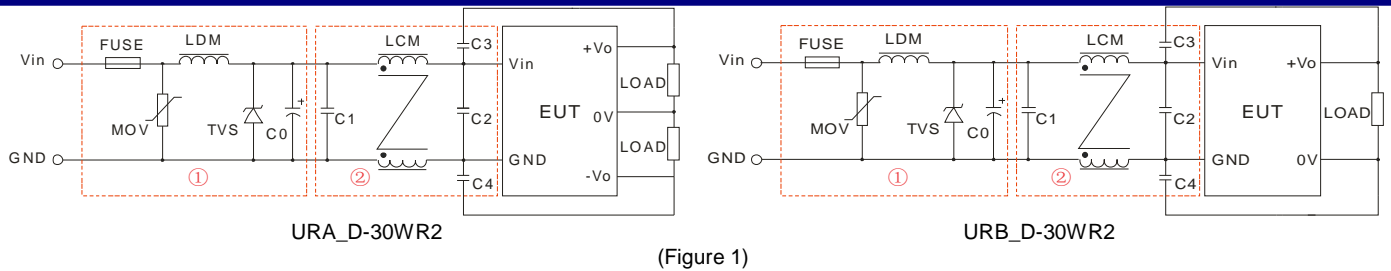

Recommended external circuit parameters:

Model	URA24_D-30WR2	URB24_D-30WR2	URA48_D-30WR2	URB48_D-30WR2
FUSE	Choose according to practical input current			
MOV	10D560K		10D101K	
LDM	56μH			
TVS	SMCJ48A		SMCJ90A	
C0	120μF/50V		120μF/100V	
C1	4.7μF /50V		2.2μF /100V	
LCM	2.2mH (FL2D-30-222)			
C2	4.7μF /50V		2.2μF /100V	
C3,C4	1nF/2KV			

Note: 1. In Figure 1, part ① is EMS Recommended external circuit, part ② is EMI recommended external circuit. Choose according to requirements.
 2. FL2D-30-222 is the EMC auxiliary component of our company.

EMC RECOMMENDED CIRCUIT PCB LAYOUT

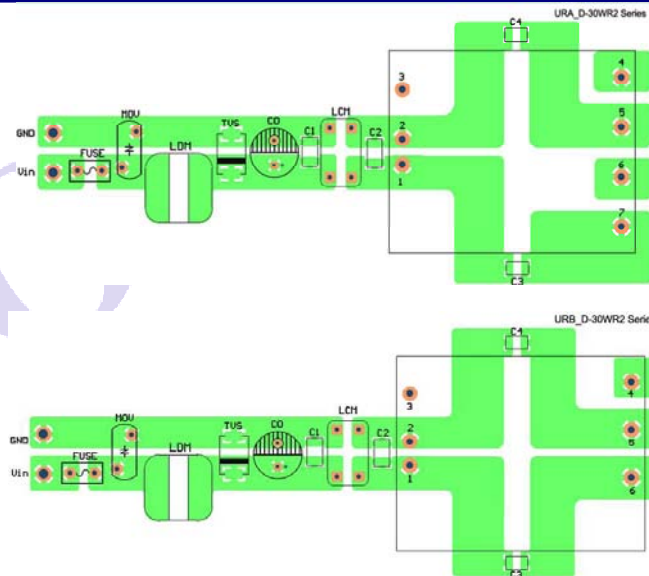

EMC TEST WAVEFORM (CLASS B APPLY CIRCUIT)

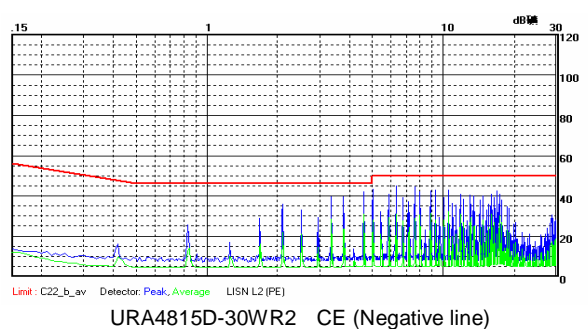
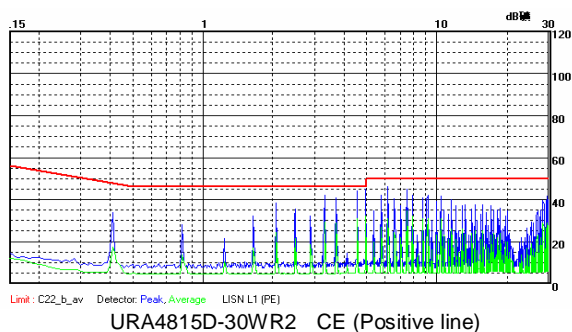

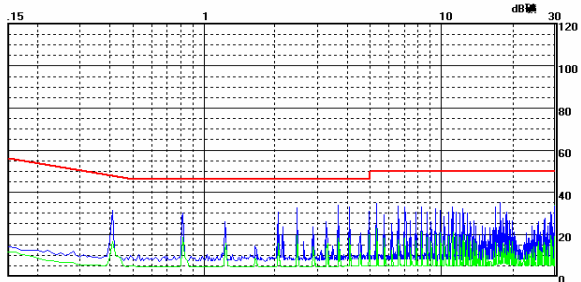

URB2405D-30WR2 CE(Positive line)

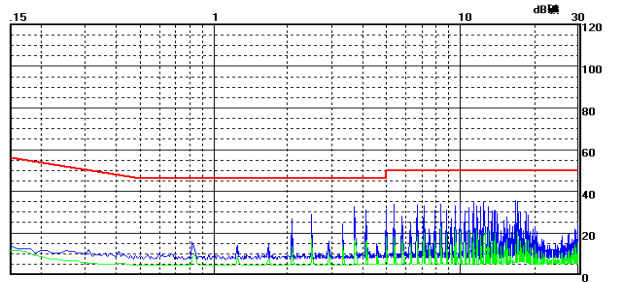

URB2405D-30WR2 CE(Negative line)

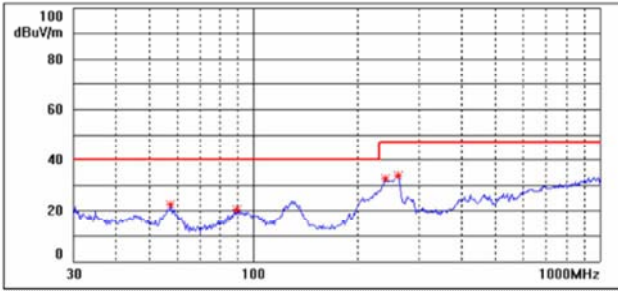

URA4815D-30WR2 RE(Horizontal)

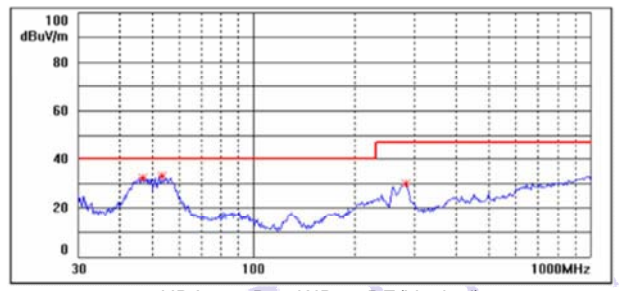

URA4815D-30WR2 RE(Vertical)

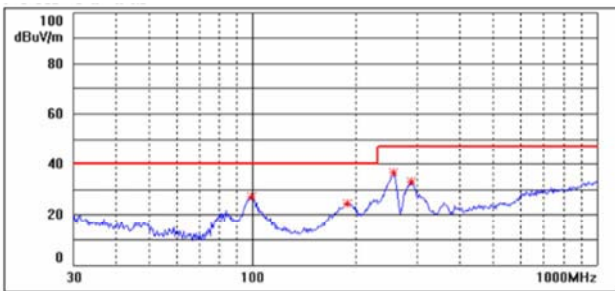

URB2405D-30WR2 RE(Horizontal)

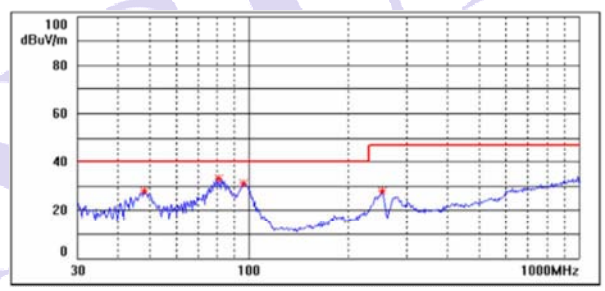

URB2405D-30WR2 RE(Vertical)

PRODUCT TYPICAL CURVE

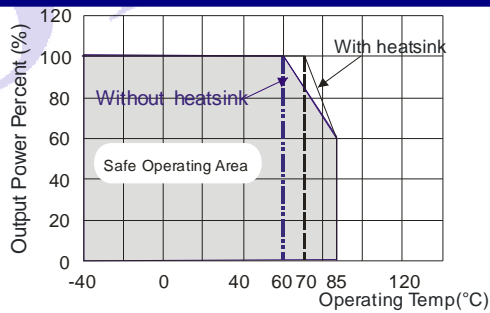

(Figure 3)

Efficiency VS Input Voltage curve (Full Load)

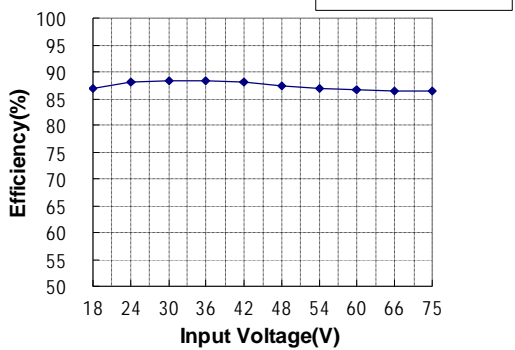

Efficiency VS Output Load curve (Vin=Vin-nominal)

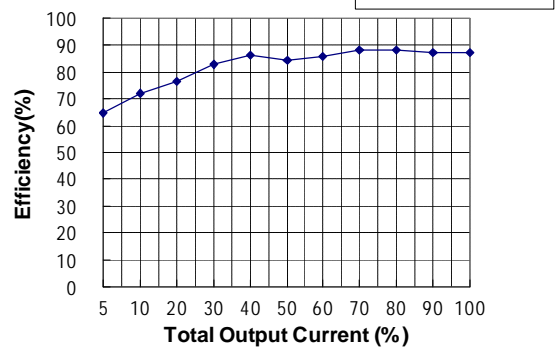

Efficiency VS Input Voltage curve (Full Load)

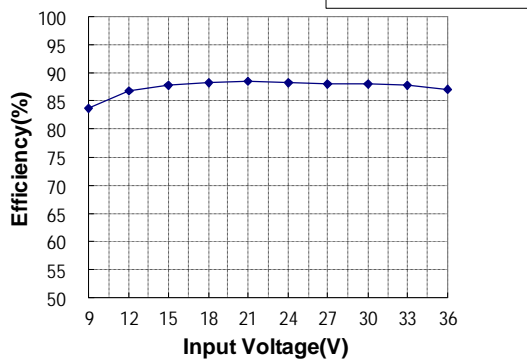

Efficiency VS Output Load curve (Vin=Vin-nominal)

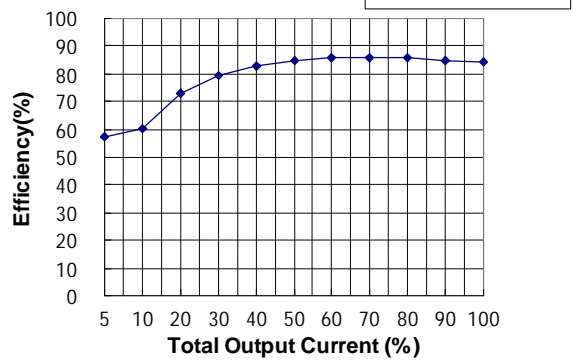

DIMENSIONS, RECOMMENDED FOOTPRINT & PACKAGING

MECHANICAL DIMENSIONS

PIN CONNECTION		
Pin	Single	Dual
1	Vin	Vin
2	GND	GND
3	Ctrl	Ctrl
4	Trim	Trim
5	0V	-Vo
6	+Vo	0V
7	No Pin	+Vo

Note:
 Unit :mm[inch]
 Pin diameter tolerances :±0.1mm[±0.004inch]
 Pin height tolerances :±0.5mm[±0.020inch]
 General tolerances:±0.25mm[±0.010inch]

THIRD ANGLE PROJECTION

RECOMMENDED FOOTPRINT DETAILS

Note : Grid 2.54*2.54mm

TUBE PACKAGING DIMENSIONS (WITHOUT HEATSINK)

Note:
 Unit :mm[inch]
 General tolerances :±0.5mm[±0.020inch]
 L=220mm[8.661 inch] Tube Quantity:4 pcs
 Inner carton(S):L*W*H=255*170*80mm
 Outer carton(S):L*W*H=375*280*270mm,6 inner cartons(S)

HEATSINK ASSEMBLY & PACKAGE DIAGRAM

MECHANICAL DIMENSIONS (WITH HEATSINK)

Note:
 Unit :mm[inch]
 General tolerances:±0.30mm[±0.012inch]
 If use heat sinks, make sure there is enough space for a specific size in the above graph.

THIRD ANGLE PROJECTION

TUBE PACKAGING DIMENSIONS (WITH HEATSINK)

Note:
 Unit :mm[inch]
 General tolerances :±0.5mm[±0.020inch]
 L=220mm[8.661 inch] Tube Quantity:4 PCS
 Inner carton(S):L*W*H=255*170*80mm
 Outer carton(S):L*W*H=375*280*270mm,6 inner cartons(S)

TEST CONFIGURATIONS

Input Reflected-Ripple Current Test Setup

Input reflected-ripple current is measured with an inductor L_{in} and C_{in} to simulate source impedance.

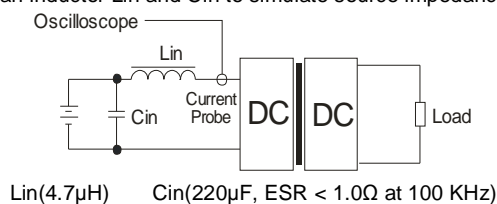

TRIM APPLICATION & TRIM RESISTANCE

Application circuit for TRIM (Part in broken line is the interior of models)

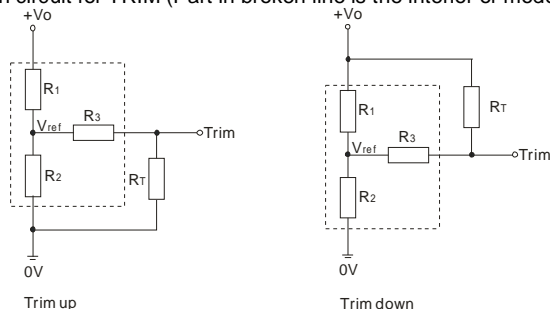

Formula for resistance of TRIM

$$\text{up: } R_T = \frac{aR_2}{R_2 - a} - R_3 \quad a = \frac{V_{ref}}{V_o' - V_{ref}} \cdot R_1$$

$$\text{down: } R_T = \frac{aR_1}{R_1 - a} - R_3 \quad a = \frac{V_o' - V_{ref}}{V_{ref}} \cdot R_2$$

Note: Leave open if not used. Value for R_1 , R_2 , R_3 , and V_{ref} refer to the below table 1, R_T : Resistance of Trim. a : User-defined parameter, no actual meanings. V_o' : The trim up/down voltage.

TRIM parameter (Table 1)

Parameter \ V_o	5 (VDC)	12 (VDC)	15 (VDC)
$R_1(K\Omega)$	2.883	10.971	14.497
$R_2(K\Omega)$	2.864	2.864	2.864
$R_3(K\Omega)$	10	17.8	17.8
$V_{ref}(V)$	2.5	2.5	2.5

DESIGN CONSIDERATIONS

1) Recommended circuit

All the URA_D-30WR2 & URB_D-30WR2 Series have been tested according to the following recommended test circuit before leaving the factory (see Figure 4).

If you want to further decrease the input/output ripple, you can increase a capacitance-values properly or choose capacitors with low ESR, but the total capacitance of the filter capacitor must not exceed the Max. Capacitive Load.

Recommend external capacitor see table 2.

Dual O output

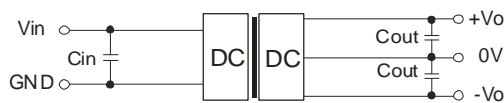

Single Output

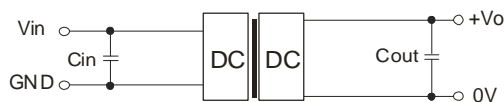

(Figure4)

(Table 2)

Single Vout (VDC)	C_{in} (μF)	C_{out} (μF)	Dual Vout (VDC)	C_{in} (μF)	C_{out}^* (μF)
3.3/5	10 μF	10 μF	± 5	10 μF	10 μF
12/15	10 μF	4.7 μF	$\pm 12/\pm 15$	10 μF	4.7 μF

Note: *For each output

2) It is not recommended to increase the output power capability by connecting two or more converters in parallel. The product is not hot-swappable

Note:

1. Min. load shouldn't be less than 5%, otherwise ripple maybe increased dramatically, If the product operates under min. load, it may not be guaranteed to meet all specifications listed. Operation under minimum load will not damage the converter.
2. Recommended Dual output models unbalanced load is $\leq \pm 5\%$, If the product operates $> \pm 5\%$, it may not be guaranteed to meet all specifications listed. Please contact our technical support for more details.
3. Max. Capacitive Load is tested at input voltage range and full load.
4. All specifications measured at $T_a=25^\circ\text{C}$, humidity $<75\%$, nominal input voltage and rated output load unless otherwise specified.
5. In this datasheet, all test methods are based on our corporate standards.
6. All characteristics are for listed models, and non-standard models may perform differently. Please contact our technical support for more details.
7. Please contact our technical support for any specific requirement.
8. Specifications of this product are subject to changes without prior notice.

MORNSUN Science & Technology Co.,Ltd.

Address: No. 5, Kehui St. 1, Kehui development center, Science Ave., Guangzhou Science City, Luogang district, Guangzhou,P.R.China.

Tel: 86-20-38601850

Fax:86-20-38601272

E-mail: info@mornsun.cn

[Http://www.mornsun-power.com](http://www.mornsun-power.com)

MORNSUN