

1. Applications

- n DC-DC converters and Off-line UPS
- n Switching applications

2. Features

- n $R_{DS(on)}$ (TYP)= 2.2m Ω @ V_{GS} = 10 V
- n Super high dense cell design
- n Ultra low on-resistance
- n 100% avalanche test
- n Lead free and green devices available (RoHS compliant)
- n

3. Pin configuration

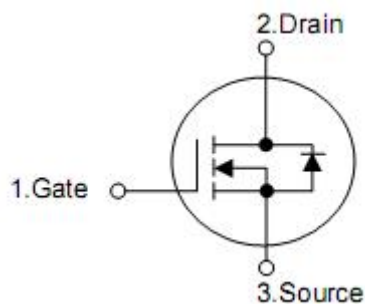
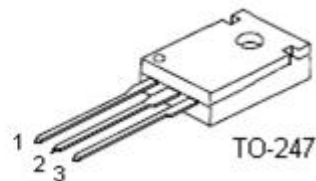
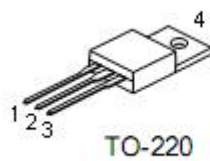

Pin	Function
1	Gate
2	Drain
3	Source
4	Drain

4. Absolute maximum ratings

($T_C=25\text{ }^\circ\text{C}$, unless otherwise specified)

Parameter		Symbol	Ratings		Units
Drain-source voltage		V_{DSS}	40		V
Gate-source voltage		V_{GSS}	± 20		V
Operating and Storage temperature range		T_J & T_{STG}	-55~+175		$^\circ\text{C}$
Diode continuous forward current ¹	$T_C=25\text{ }^\circ\text{C}$	I_S	190		A
Continuous drain current $V_{GS}=10\text{ V}^1$	$T_C=25\text{ }^\circ\text{C}$	I_D	190		A
Continuous drain current $V_{GS}=10\text{ V}^1$	$T_C=100\text{ }^\circ\text{C}$		146		A
300us pulse drain current tested ²	$T_C=25\text{ }^\circ\text{C}$	I_{DP}	760		A
Single pulse Avalanche energy		E_{AS}	812		mJ
Power dissipation	$T_C=25\text{ }^\circ\text{C}$	P_D	224	325	W
	$T_C=100\text{ }^\circ\text{C}$		112	162.5	W

5. Thermal characteristics

Parameter	Symbol	Rating	Unit
Thermal resistance, Junction-to-case	θ_{JC}	0.5	$^\circ\text{C/W}$

6. Electrical characteristics

(T_C=25°C, unless otherwise notes)

Parameter	Symbol	Conditions	Min	Typ	Max	Unit
Off Characteristics						
Drain-source breakdown voltage	BV _{DSS}	V _{GS} =0V, I _D =250μA	40	-	-	V
Drain-to-source leakage current	I _{DSS}	V _{DS} =40V, V _{GS} =0V	-	-	1	μA
		V _{DS} =40V, V _{GS} =0V, T _J =85 °C	-	-	30	μA
Gate-to-source leakage current	I _{GSS}	V _{GS} =20V, V _{DS} =0V	-	-	100	nA
		V _{GS} =-20V, V _{DS} =0V	-	-	-100	nA
On characteristics						
Gate threshold voltage	V _{GS(th)}	V _{DS} =V _{GS} , I _D =250μA	2.0	3.0	4.0	V
Static drain-source on-resistance ⁴	R _{DS(on)}	V _{GS} =10V, I _D =75A	-	2.2	3.5	mΩ
Dynamic characteristics						
Diode forward voltage	V _{SD}	V _{GS} =0V, I _S =75A	-	-	1.2	V
Reverse recovery time	t _{rr}	I _{SD} =75A, di _F /dt=100A/μs,	-	40	-	ns
Reverse recovery charge	Q _{rr}		-	52	-	nC
Gate resistance	R _G	V _{DS} =0V, V _{GS} =0V, f=1.0MHz	-	1.2	-	Ω
Input capacitance	C _{iSS}	V _{DS} =20V, V _{GS} =0V, f=1.0MHz	-	4800	-	pF
Output capacitance	C _{oss}		-	950	-	pF
Reverse transfer capacitance	C _{rSS}		-	480	-	pF
Total gate charge	Q _g		-	120	-	nC
Gate-source charge	Q _{gs}	V _{DS} =32V, I _D =75A, V _{GS} =10V,	-	34	-	nC
Gate-drain (Miller) charge	Q _{gd}		-	46	-	nC
Resistive swiching characteristics			Essentially independent of operating temperature			
Turn-on-delay time	t _{d(ON)}	V _{DD} =20V, R _L =0.3Ω, I _D =75A, V _{GEN} =10V, R _G =2.5Ω	-	19	-	nS
Rise time	t _{rise}		-	96	-	
Turn-off-delay time	t _{d(OFF)}		-	70	-	
Fall time	t _{fall}		-	50	-	

- Note: 1. Calculated continuous current based on maximum allowable junction temperature. Package limitation current is 75A.
2. Pulse width limited by safe operating area.
3. Limited by T_{Jmax}, I_{AS}=57A, V_{DD}=32V, R_G=50Ω, starting T_J=25 °C.
4. Pulse test; Pulse width ≤300μs; duty cycle ≤2%.
5. Guaranteed by design, not subject to production testing.

7. Test circuits and waveforms

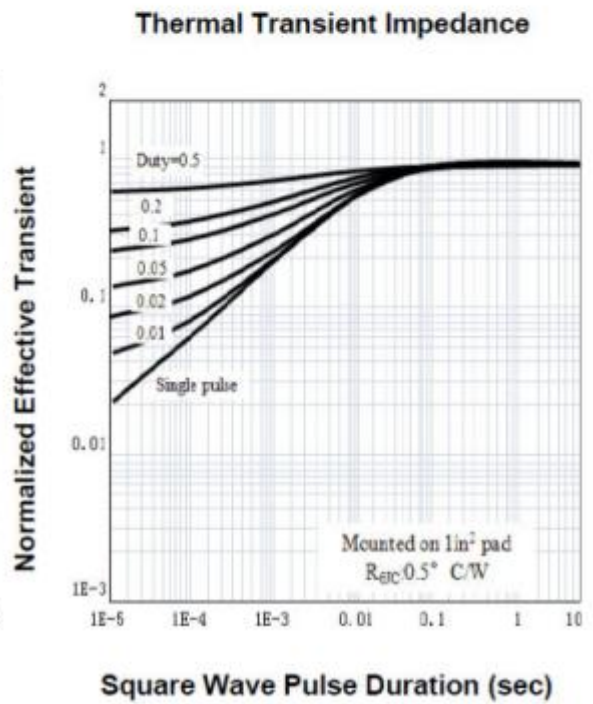
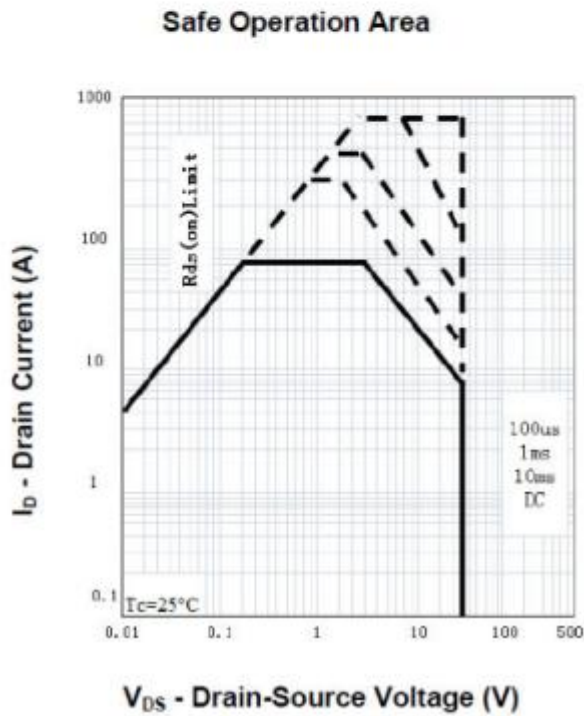
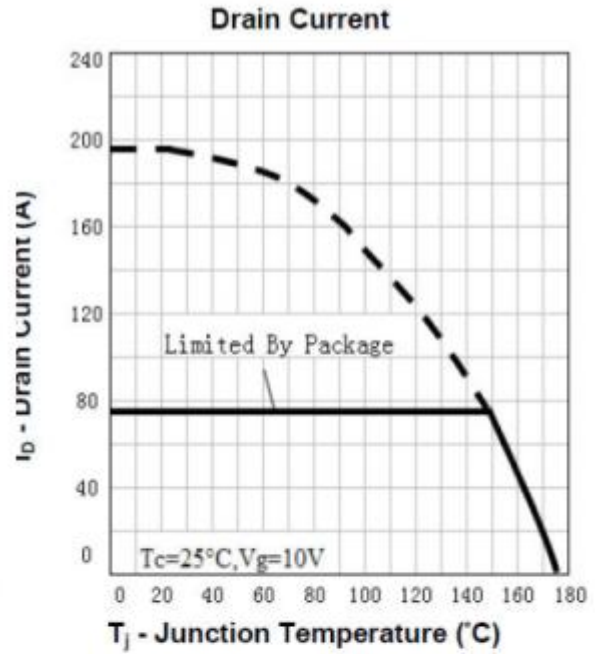
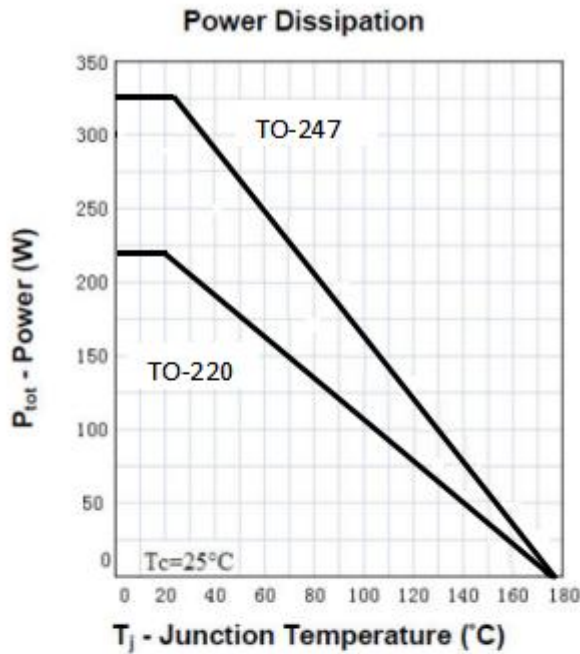

Output Characteristics

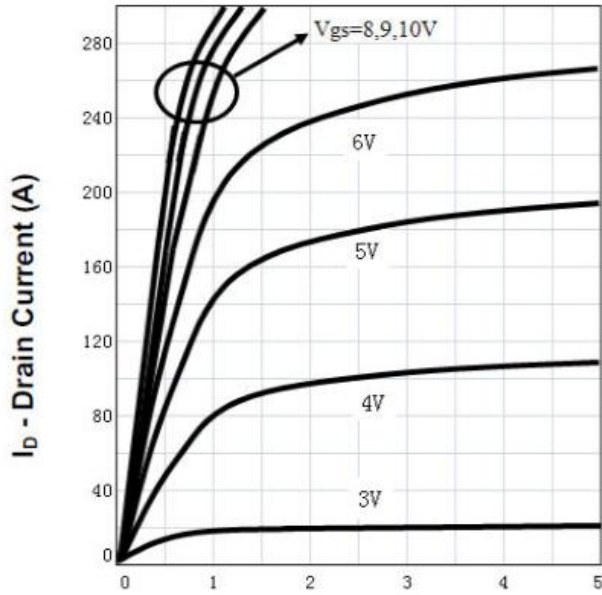

V_{DS} - Drain-Source Voltage (V)

Drain-Source On Resistance

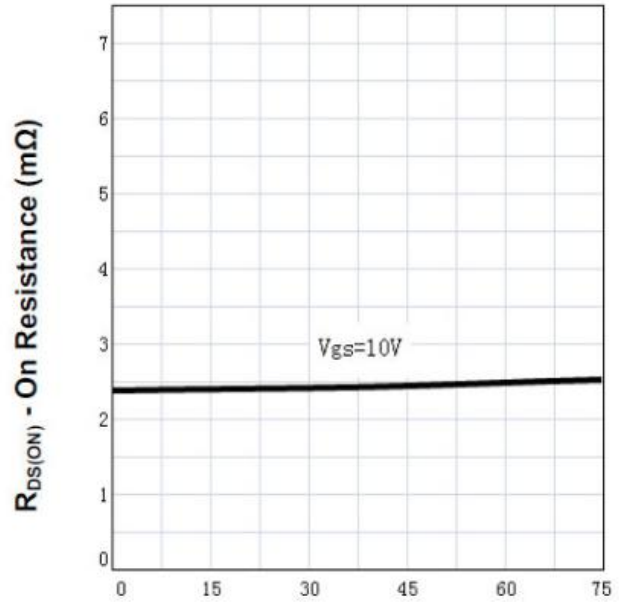

I_D - Drain Current (A)

Drain-Source On Resistance

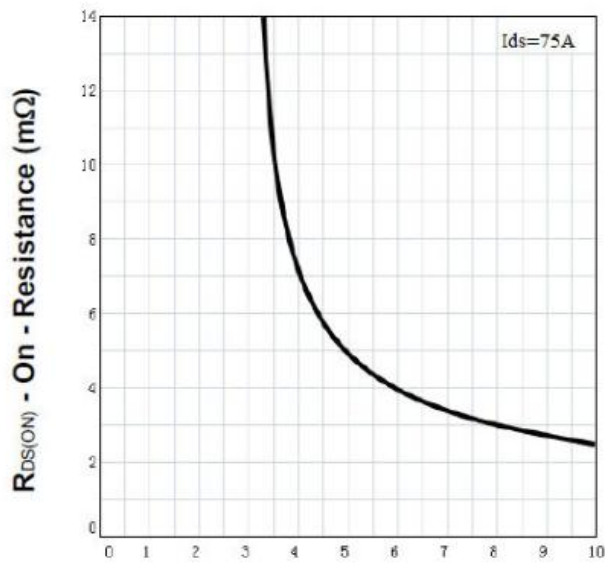

V_{GS} - Gate-Source Voltage (V)

Gate Threshold Voltage

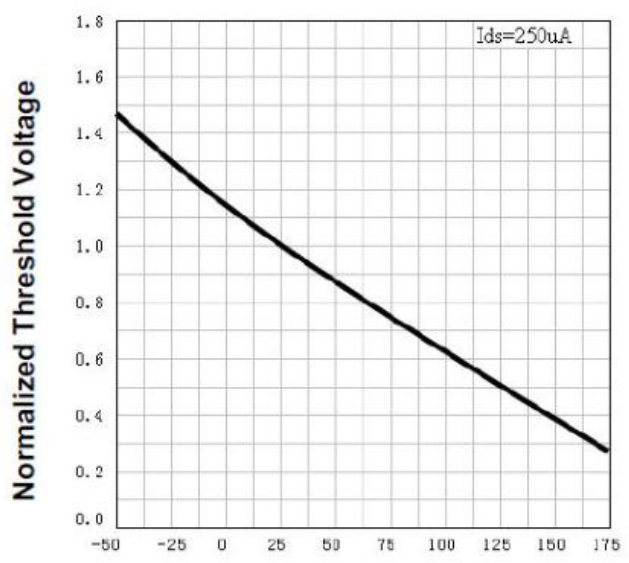

T_J - Junction Temperature ($^{\circ}C$)

Drain-Source On Resistance

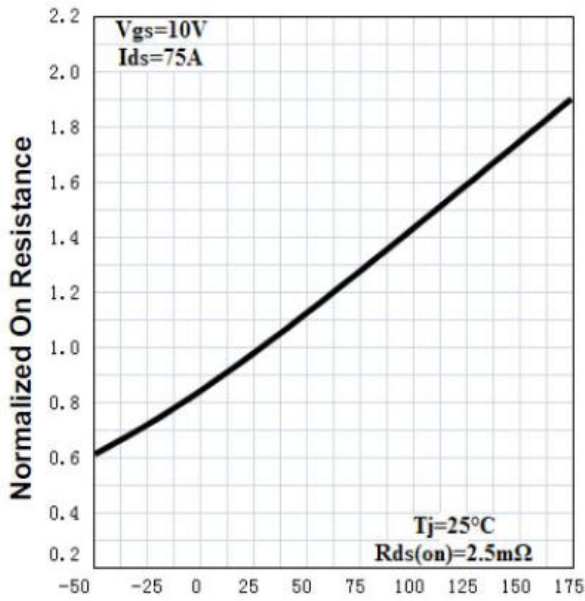

T_j - Junction Temperature (°C)

Source-Drain Diode Forward

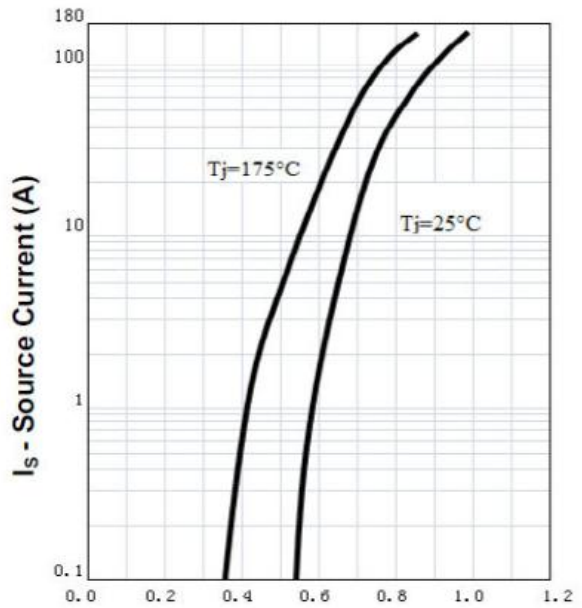

V_{SD} - Source-Drain Voltage (V)

Capacitance

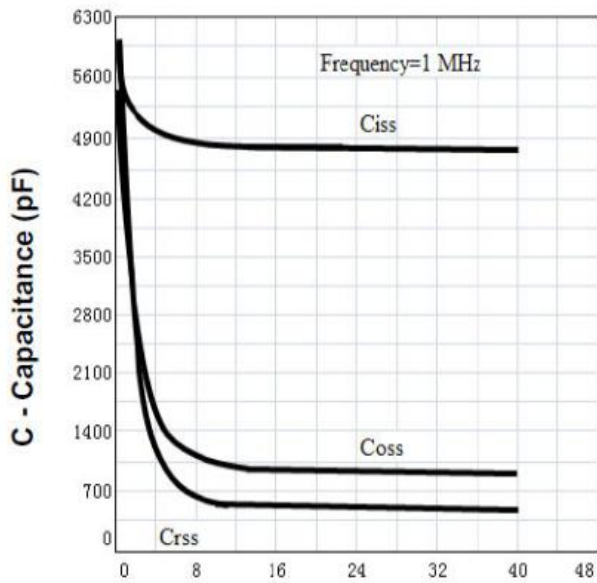

V_{DS} - Drain-Source Voltage (V)

Gate Charge

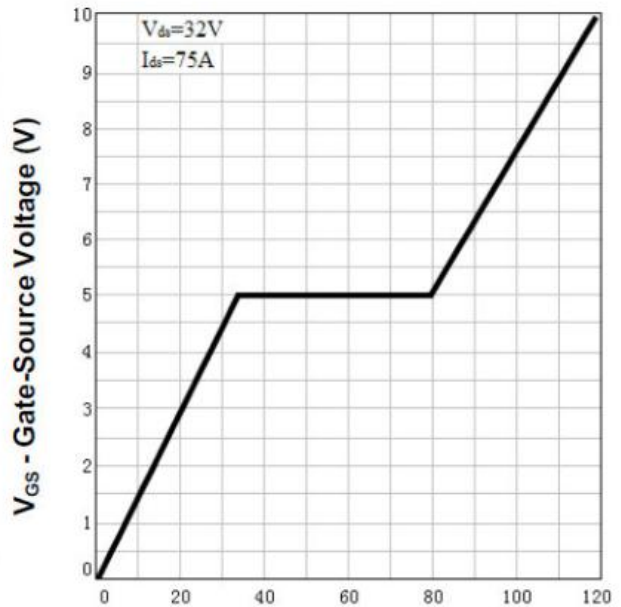

Q_G - Gate Charge (nC)

Avalanche Test Circuit and Waveforms

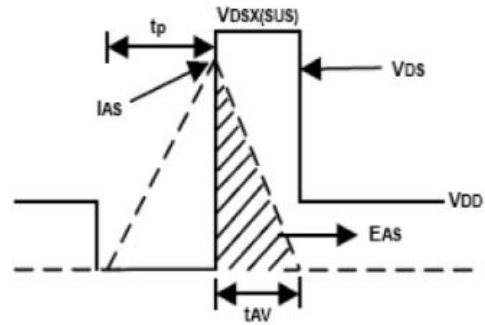
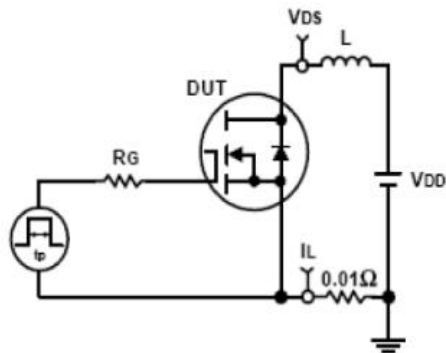

Switching Time Test Circuit and Waveforms

