

UC-5

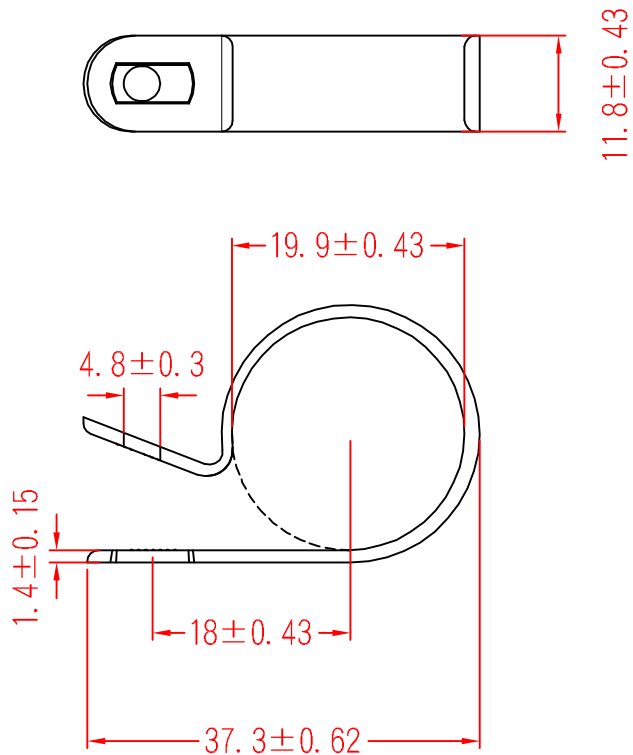

承認

 98.06.02
 邱平裕

審查

製圖

 98.06.02
 謝文通

設計

中文名
 配線固定鈕

MATERIAL UL 94V-2
 NYLON 66

ITEM NO.
 UC-5

SCALE

FINISH

NAME
 CABLE CLAMP

使用機種

 (. .)

TOLERANCE
 AS FIGURE

 06-02-2009
 DATE

REVISIONS K001

R.NO.



凱士士企業股份有限公司

▶ 請勿實測圖面 ◀