

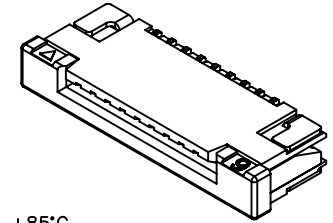

P/N LEGEND

F1003 WR-S-XP N L N XX X TO R  
 ① ② ③ ④ ⑤ ⑥ ⑦ ⑧ ⑨ ⑩ ⑪

- ① Series No.
- ② Connector type: WR=Right angle
- ③ Mounting type: S=SMT
- ④ No. of circuits
- ⑤ N=Halogen Free
- ⑥ Material: L=LCP
- ⑦ Color: N=Natural(Beige)
- ⑧ Plating code for contacts:  
T1=Matte Tin-plated; G1=Gold-flash
- ⑨ Plating code for solder tabs:  
T=Matte Tin-plated; G=Gold-flash
- ⑩ Option code: T0=Top contact style
- ⑪ Packing code:  
R=Tape & Reel(Without Cap or Mylar)



SPECIFICATIONS

Current Rating: 0.5A AC,DC  
 Voltage Rating: 50V AC,DC  
 Temperature Range: -25°C ~ +85°C  
 Contact Resistance: 30mΩ Max.  
 Insulation Resistance: 500MΩ Min.  
 Withstanding Voltage: 500V AC/minute  
 Contacts: Phosphor Bronze/Matte Tin-plated or Gold-flash  
 Solder Tabs: Brass/Matte Tin-plated or Gold-flash  
 Housing: LCP,UL94V-0,Natural(Beige)  
 Actuator: Nylon 6T,UL94V-0,Natural(Black)

Circuit No.	Dimensions			Circuit No.	Dimensions		
	A	B	C		A	B	C
04P	3.00	11.00	5.10	20P	19.00	27.00	21.10
05P	4.00	12.00	6.10	21P	20.00	28.00	22.10
06P	5.00	13.00	7.10	22P	21.00	29.00	23.10
07P	6.00	14.00	8.10	23P	22.00	30.00	24.10
08P	7.00	15.00	9.10	24P	23.00	31.00	25.10
09P	8.00	16.00	10.10	25P	24.00	32.00	26.10
10P	9.00	17.00	11.10	26P	25.00	33.00	27.10
11P	10.00	18.00	12.10	27P	26.00	34.00	28.10
12P	11.00	19.00	13.10	28P	27.00	35.00	29.10
13P	12.00	20.00	14.10	29P	28.00	36.00	30.10
14P	13.00	21.00	15.10	30P	29.00	37.00	31.10
15P	14.00	22.00	16.10	31P	30.00	38.00	32.10
16P	15.00	23.00	17.10	32P	31.00	39.00	33.10
17P	16.00	24.00	18.10	33P	32.00	40.00	34.10
18P	17.00	25.00	19.10	34P	33.00	41.00	35.10
19P	18.00	26.00	20.10				

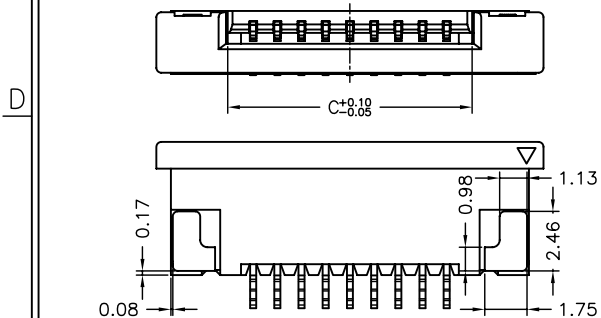
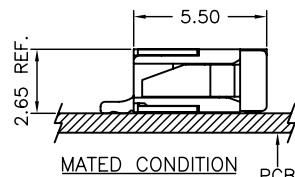
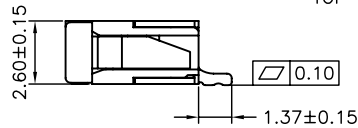
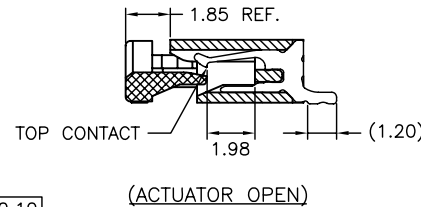
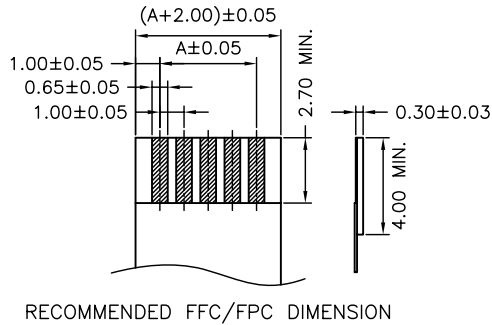
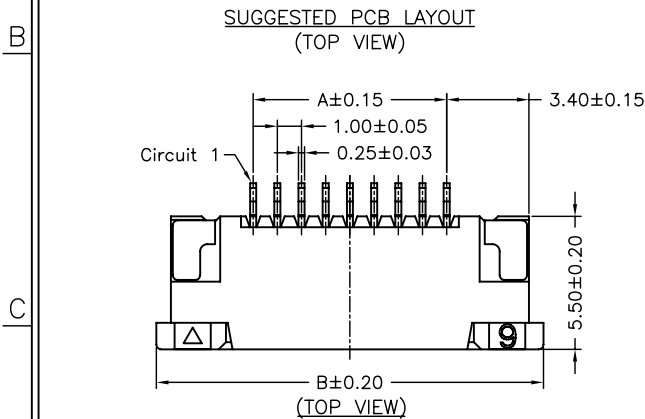
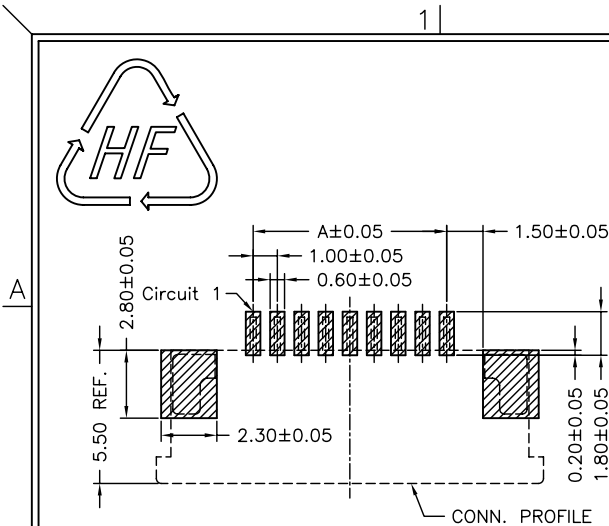

				燦達電子工業股份有限公司 JOINT TECH ELECTRONIC IND. CO., LTD.			
		UNIT	SCALE	SHEET		TITLE:	
		mm	1 : 1	1 of 2		1.00mm PITCH FFC/FPC	
		DRAWN BY		APPROVED BY		CONNECTOR, 90° SMT TYPE,	
		王自友		董正一		ZIF, TOP CONTACT STYLE	
		2009.11.26		2009.11.26			
		GENERAL TOLERANCE					
A2	EN1011150264	2010.11.15	權生新	X.X±0.25	ANGLE±		DRAW NO. : F1003WR-S-XPXXXXXXTOX
A1	EN1008170218	2010.08.16	權生新	X.XX±0.15			
REV.	DESCRIPTION	DATE	NAME	X.XXX±0.05			
						REV. A2	