



湖北匡通电子有限公司

Hubei Kento Electronic Co., Ltd

发光二极管产品规格书  
Specification for LED Product

产品型号: 2A5R2UC12

■ 尺寸规格(毫米)

Package Dimensions(mm)

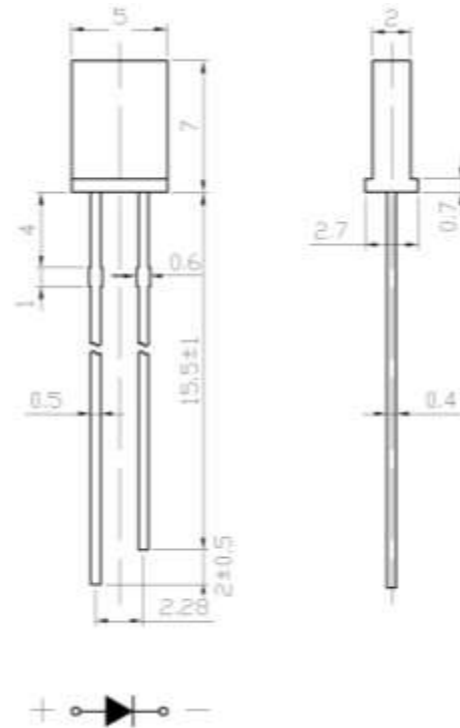

注解:

Notes:

1. 所有尺寸单位是mm  
All dimension units are millimeters.
2. 所有未标注尺寸公差为 $\pm 0.2\text{mm}$   
All dimension tolerance is  $\pm 0.2\text{mm}$  unless otherwise noted.
3. 所有胶体底部与引脚处多胶部分大约为1.5mm  
An epoxy meniscus may extend about 1.5mm down the leads.
4. 胶体底部毛边小于等于0.5mm  
Burr around bottom of epoxy may be 0.5mm max.

简介:	2X5mm 方形	无色透明胶体
Synopsis:	2X5mm Square Type	Water Clear Lens
	红色发光二极管	
	Red LED Lamp	



# 湖北匡通电子有限公司

Hubei Kento Electronic Co., Ltd

产品型号: 2A5R2UC12						
■ 主要光电特性 (室温 = 25°C) Typical Electrical & Optical Characteristics (Ta = 25°C)						
项目 ITEMS	符号 SYMBOL	条件 CONDITION	最小值 MIN.	典型值 TYP.	最大值 MAX.	单位 UNIT
正向电压 Forward Voltage	VF	IF = 20mA	1.4	1.8	2.5	V
反向电流 Reverse Current	IR	VR = 5V	---	---	1	μA
主波长 Dominant Wavelength	λ D	IF = 20mA	620	---	630	nm
发光强度 Luminous Intensity	IV	IF = 20mA	110	120	140	mcd
50%能量发光视角 50% Power Viewing Angle	2θ½	IF = 20mA	---	---	---	deg
■ 最大绝对额定值 (室温 = 25°C) Absolute Maximum Ratings at (Ta = 25°C)						
项目 ITEMS	符号 SYMBOL	最大绝对额定值 ABSOLUTE MAXIMUM RATING			单位 UNIT	
正向电流 Forward Current	IF	50			mA	
峰值正向电流 Peak Forward Current	IFP	220			mA	
连续工作电流 Continuous Forward Current	IL	20			mA	
反向电压 Reverse Voltage	VR	5			V	
功耗 Power Dissipation	PD	90			mW	
工作温度 Operation Temperature	Topr	-40 ~ +80			°C	
贮存温度 Storage Temperature	Tstg	-40 ~ +80			°C	
引脚镀锡温度 Lead Soldering Temperature	Tsol	最大温度260°C,最长时间5 秒 Max.260 °C for 5 sec Max.				

IFP 条件: 脉冲宽度小于等于10 分钟

IFP Conditions: Pulse Width ≤ 10msec duty ≤ 1/10

Tsol 条件: 离胶体底部4mm 处为基础

Tsol Conditions: 4mm from the base of the epoxy bulb



# 湖北匡通电子有限公司

Hubei Kento Electronic Co., Ltd

产品型号: 2A5R2UC12					
■ 半功视角 Spatial Distribution					
■ 可靠性试验 Reliability Performance					
测试分类 Test Classification	测试项目 Test Item	测试条件 Test Conditions	测试持续时间 Test Duration	抽样大小 Sample Size	判定 Standard
寿命测试 Life Test	寿命测试 Life Test	Ta=25°C ±5°C, IF=20mA	1000小时(hrs)	10PCS	Qualified
环境测试 Environment Test	热冲击测试 Thermal Shock Test	-10°C ±5°C ↔ +100°C ±5°C 5min. 10sec. 5min.	100循环(cycles)	10PCS	Qualified
	冷热循环测试 Temperature Cycle Test	-55°C ±5°C ↔ +85°C ±5°C 30min. 5min. 30min.	100循环(cycles)	10PCS	Qualified
	高温高湿测试 High Temperature & High Humidity Test	Ta=85°C ±5°C RH =85% ±0.5 %RH	240小时(hrs)	10PCS	Qualified
	高温贮存测试 High Temperature Storage	Ta=100°C ±5°C	1000小时(hrs)	10PCS	Qualified
	低温贮存测试 Low Temperature Storage	Ta=-55°C ±5°C	1000小时(hrs)	10PCS	Qualified
机械测试 Mechanical Test	抗焊接热度 Resistance to Soldering Heat	Ta=260°C ±5°C	5 秒(sec.)	10PCS	Qualified
	引脚折弯 Lead Integrity	负荷2.5 牛顿(0.25 千克) 0°~ 90°~ 0°	3 回合(times)	10PCS	Qualified



湖北匡通电子有限公司

Hubei Kento Electronic Co., Ltd

产品型号: 2A5R2UC12

■典型的光电特性曲线 (Ta=25°C 除非不同地方)

Typical Optical/Electrical Characteristics Curves (Ta=25°C Unless Otherwise Noted)

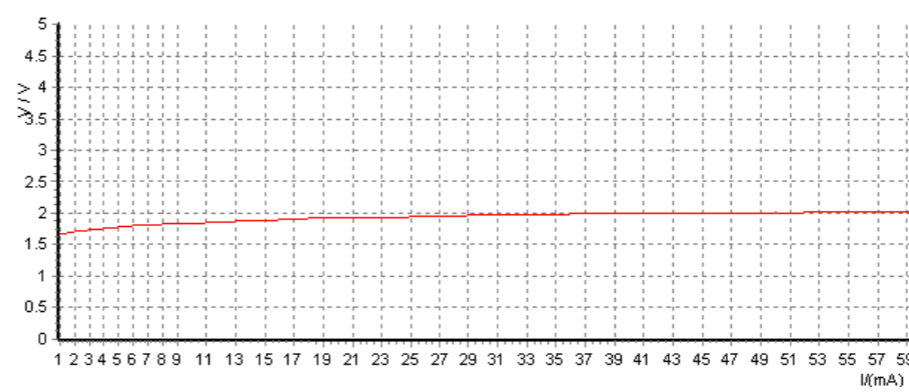
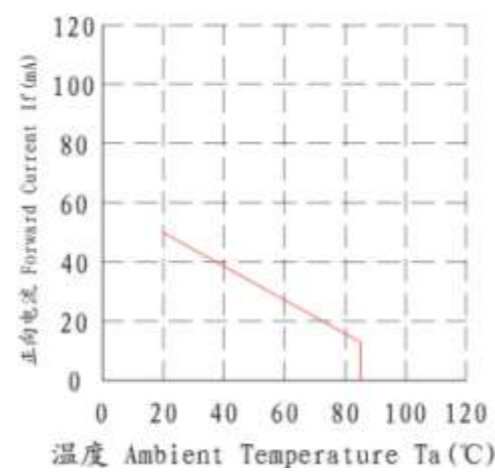

电流-电压曲线  
Current-Voltage Curve

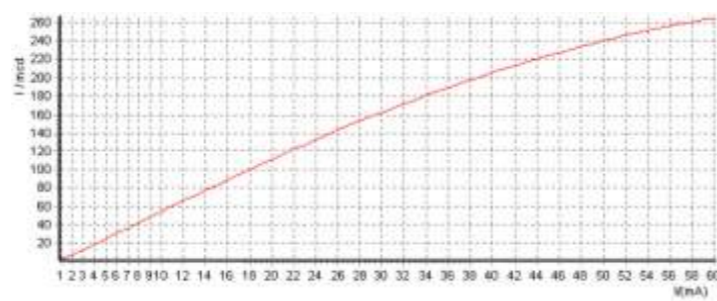

电流-光强曲线  
Current-Luminous intensity Curve

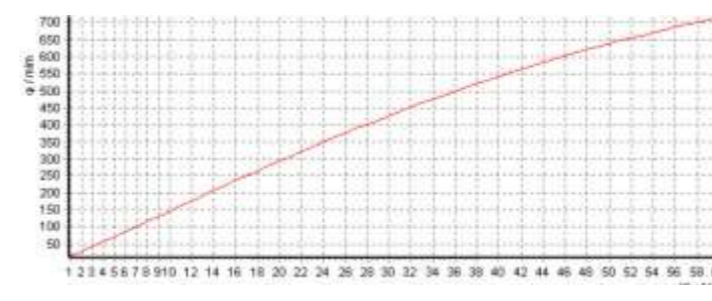

电流-光通量曲线  
Current-Luminous flux Curve

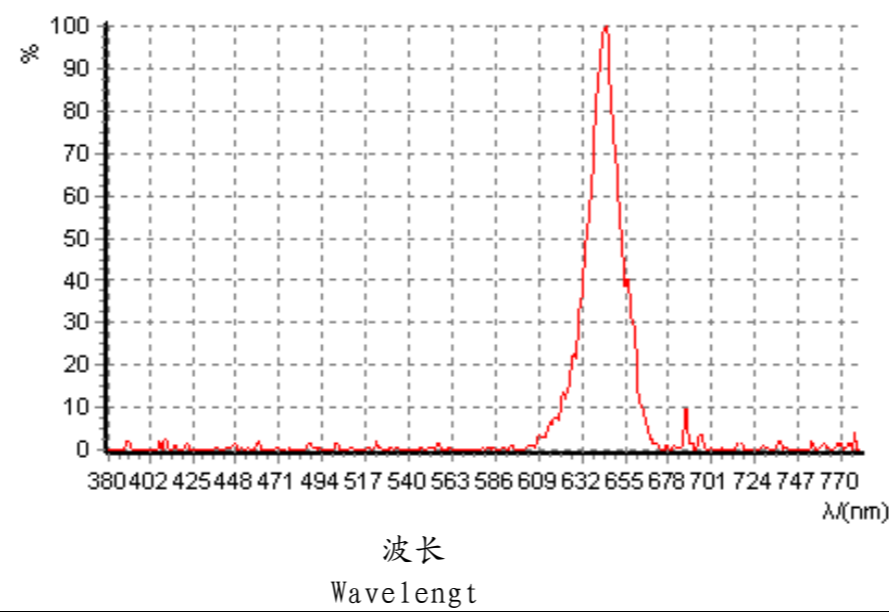

波长  
Wavelength



# 湖北匡通电子有限公司

Hubei Kento Electronic Co., Ltd

产品型号：2A5R2UC12

## 1. 应用

此LED可使用于一些普通的电子设备，例如办公设备，通信设备、房屋装饰，若LED用在一些可靠性要求较高的情况下，如航空运输，交通控制及医辽器械时，一定需参考销售提供之资料进行使用。

This LED can be used in the some of the common electronic devices, such as office equipment, communications equipment, building decoration, if LED used in some higher reliability requirements, such as air transport, traffic control and medical devices, please do refer to products manual.

## 2. 贮存

### Storage

贮存LED的环境，温度不超过30℃，相对湿度不超过70%。建议LED在原包装箱里日期不超过三个月进行使用，如果需加长贮存时间，建议放在干燥箱内，并加放干燥剂，或者充入氮气。

Storage environment of LED, the temperature should be less than 30 ℃, relative humidity should be less than 70%. We strongly suggest that use up all the leds within 3months after purchase. If you would like to keep longer time, please keep in drying oven, put desiccant, or filled with nitrogen gas.

## 3. 清洗

### Cleaning

当用化学品清洗胶体时必须特别小心，因为有些化学品对胶体表面有损伤并引起褪色，如三氯乙烯、丙酮等。可用乙醇擦拭、浸渍，时间在常温下不超过3分钟。

Caution on the chemical when doing the cleaning. Because some chemical supplies can cause damage to the surface of colloid with fade, such as three vinyl chloride, Acetone, etc. It can be wiped and infused by alcohol, but please keep the time in three minutes at normal temperature.

## 4. 引脚装配

### Pins assembly

(1) 必需离胶体2毫米才能折弯支架。

Keep 2mm from the colloid when bending the stents.

(2) 支架成形必须用夹具或由专业人员来完成。

Stents forming must use fixture or taken by professional.

(3) 支架成形必须在焊接前完成。

Stents forming must be done before welding.

(4) 支架成形需保证引脚和间距与线路板上一致。

Stents forming should guarantee that pins and spacing should be in line with circuit.

(5) 焊接必须在正常温度下进行，当LED正常焊接到PCB板上后，应尽量避免在LED引脚处施加机械压力。

The welding must be processed under normal temperature, when LED is used into PCB, It is necessary to avoid a mechanical pressure on the pins of LED.

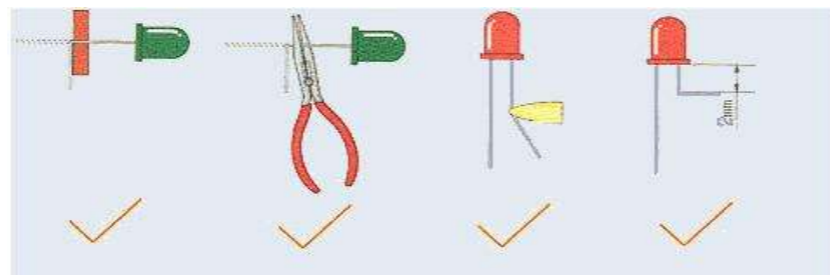



## 5. 焊接

### Welding

当焊接时，必需在胶体底部2mm以下进行焊接，在焊接时，应尽力避免浸渍LED胶体，在刚焊接完后，应避免在引脚上加外力或者摇动LED胶体。

In the welding process, it is necessary to weld in 2 mm below the bottom colloid, also should try to avoid dipping LED colloid, in just after welding, has to avoid an external force on the lead pins or a shake on the LED colloid.

The recommended welding conditions

烙铁焊接 (Influenced by iron welding)		波峰焊 (Wave peak welding)	
焊接温度 (Welding tempertuare)	260°C. Max	预热温度 (Reheating temperature)	100°C Max
焊接时间 (Welding time)	5 Sec. Max	预热时间 (Reheating time)	60 sec. Max
	(one time only)	焊接温度 (Welding temperature)	260°C. Max
		焊接时间 (Welding time)	10 sec. Max

过高的焊接温度和长时间的焊接会导致 LED 变形和失效

The high temperature and long time of welding will lead to the deformation and failure LED

## 6. 驱动方式

### Driving way

LED的当前驱动方式

The Driver of LED

若LED为多颗并联时，建议采用线路A，在每颗LED处加一限流电阻，以保证LED之亮度一致。

If for A parallel circuit, it is suggested that a resistor is assembled with each LED in the line A, this is to ensure the same luminance of each LED.

Circuit model A

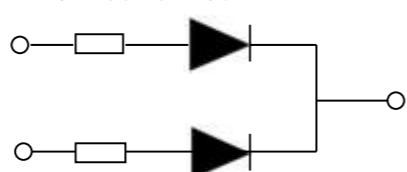

Circuit model B

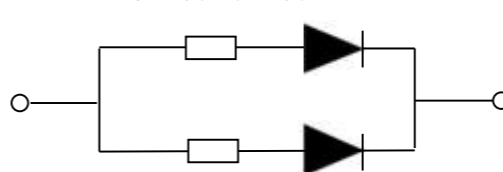

## 7. 静电防护 (Static Electricity Protective)

静电和电流的急剧升高将会对LED产生损害，KENTO系列产品使用时请使用防静电装置，如防护带和手套。

注意：使用时人体放电模式HBM<1000V；机器放电模式<100V。

Electrostatic and current of a sharp rise will cause damage on LEDs, when using KENTO series products, please use antistatic device, such as protective belt and gloves.

Note: when using it, human body discharge HBM mode  $\sim$ 1000 V; The machine discharge < 100 V