



GigaDevice Semiconductor (Beijing) Inc.

GD32 MCU
SPI NOR FLASH
SPI NAND FLASH



PRODUCT SELECTION GUIDE

About Us

Welcome to GigaDevice

GigaDevice, established in 2005, is a leading fabless company engaged in advanced memory technology and IC solutions. The company has successfully completed the IPO at Shanghai Stock Exchange in 2016. GigaDevice provides a wide range of high performance Flash memory and 32-bit general-purpose MCU products. GigaDevice is among the companies that pioneered SPI NOR Flash memory and is currently ranked number three in the world in this market segment with more than 1 billion units shipped every year.

Since 2007, GigaDevice is ISO9001 and ISO14001 certified by SGS. GigaDevice has filed 600+ patent applications with 200+ patents granted. More than 55% employees are in research and development, which continues to differentiate our products from competitions in the market. The GigaDevice management team embodies leading semiconductor industry experience from renowned memory companies in California's Silicon Valley, Korea, and Taiwan.

GigaDevice currently produces a wide range of SPI NOR Flash, SPI NAND Flash, Parallel NOR Flash and MCU for use in embedded, consumer, and mobile communications applications. GigaDevice operates a manufacturing model based on strong relationships with: foundry, assembly, and test subcontractor partners. GigaDevice believes this well-defined fabless manufacturing model provides us with a competitive advantage over the conventional fabrication-based Integrated Device Manufacturers because the capital equipment expenditure to maintain advanced memory process technologies is beyond the market return of many IC memory market segments. The consistent investment in advanced equipment by our foundry partners and their rapid growth in 12" wafer capacity are key factors in our success over our competitors.



Contents

01 ▶ GD32 MCU

18 ▶ SPI NAND Flash

14 ▶ SPI NOR Flash

20 ▶ Flash Package Options

ARM Powered®

ARM CORTEX
Processor Technology

ARM University
Worldwide Education Program

ARM Connected Community

GD32 MCU

GD32 Cortex®-M3 MCU Portfolios

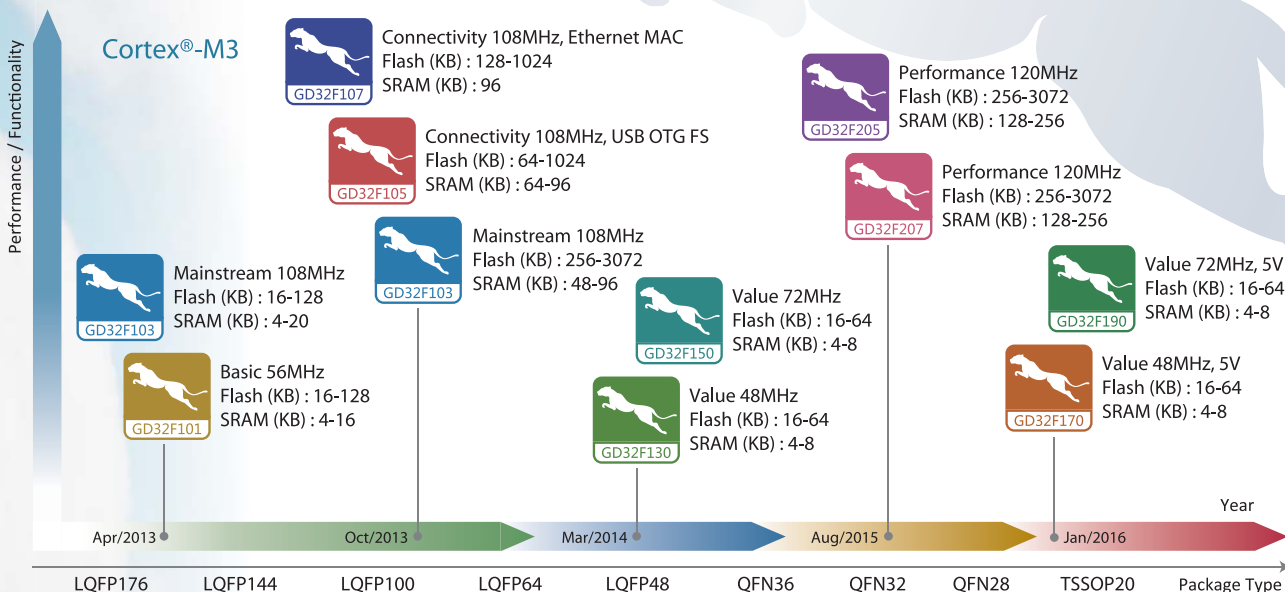

GD32 Cortex®-M4 MCU Portfolios

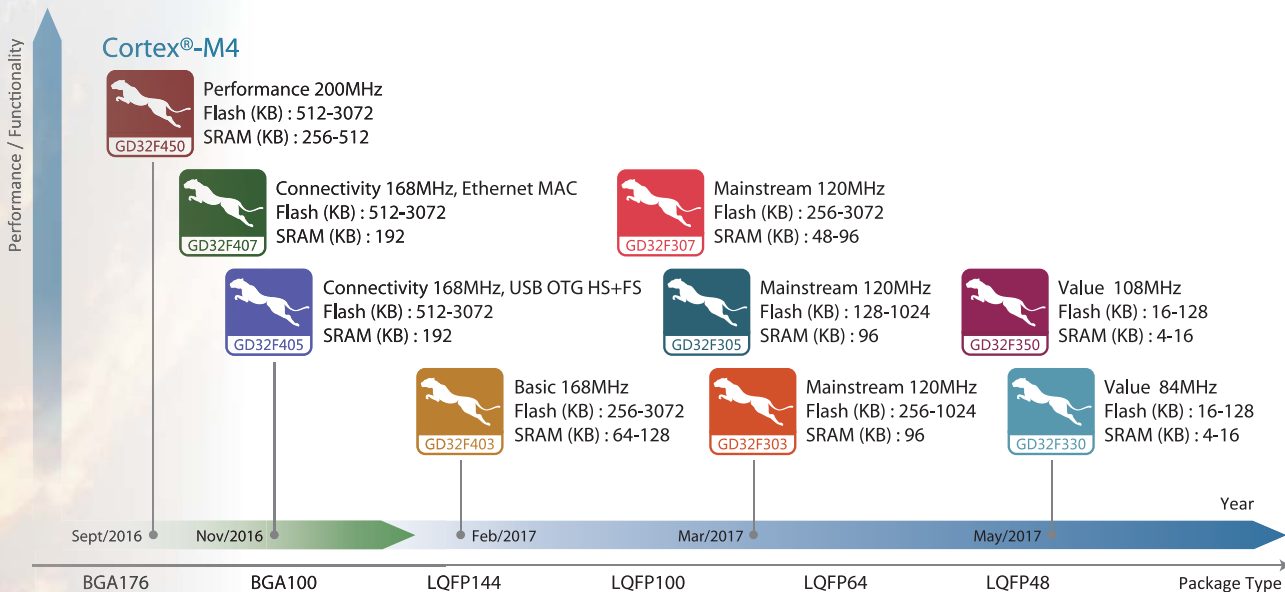

GD32 MCU Configuration

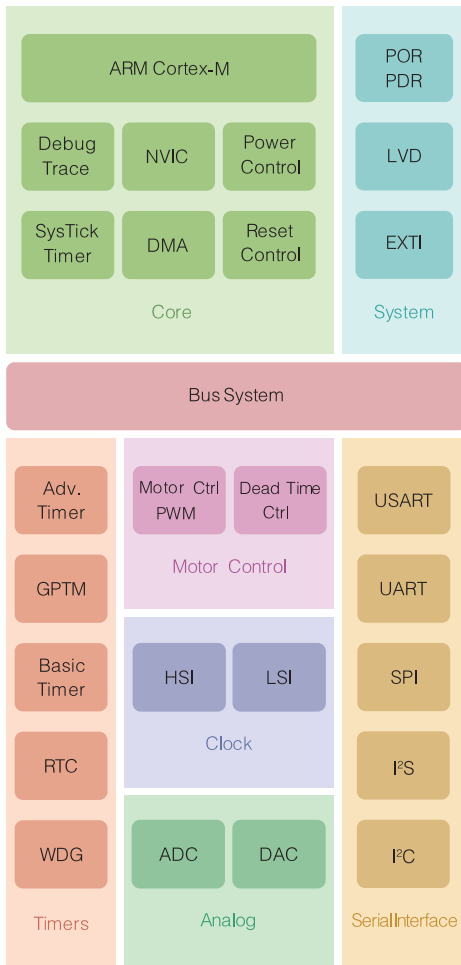

GD32F450 Performance Line	200MHz Frequency	Up to 3MB Flash	Up to 512KB SRAM	DSP FPU	CAN 2.0B	USB FS USB HS	SDIO	Camera	SDRAM	LCD TFT	IPA	Ethernet MAC
GD32F407 Performance	168MHz Frequency	Up to 3MB Flash	192KB SRAM	DSP FPU	CAN 2.0B	USB FS USB HS	SDIO	Camera	SDRAM	Ethernet MAC		
GD32F405 Performance	168MHz Frequency	Up to 3MB Flash	192KB SRAM	DSP FPU	CAN 2.0B	USB FS USB HS	SDIO	Camera				
GD32F207 Performance Line	120MHz Frequency	Up to 3MB Flash	Up to 256KB SRAM		CAN 2.0B	USB FS OTG		Camera	SDRAM	LCD TFT	Crypto Hash	Ethernet
GD32F205 Performance Line	120MHz Frequency	Up to 3MB Flash	Up to 256KB SRAM		CAN 2.0B	USB FS OTG		LCD TFT	SDRAM			
GD32F107 Connectivity Line	108MHz Frequency	Up to 1MB Flash	Up to 96KB SRAM		CAN 2.0B	USB 2.0 FS OTG		Ethernet				
GD32F105 Connectivity Line	108MHz Frequency	Up to 1MB Flash	Up to 96KB SRAM		CAN 2.0B	USB 2.0 FS OTG						
GD32F103 Mainstream Line	108MHz Frequency	Up to 3MB Flash	Up to 96KB SRAM		CAN 2.0B	USB 2.0 FS		SDIO				
GD32F101 Basic Line	56MHz Frequency	Up to 3MB Flash	Up to 80KB SRAM									
GD32F190 5V Value Line	72MHz Frequency	Up to 64KB Flash	Up to 8KB SRAM		CAN 2.0B		Segment LCD	Advanced Analog				
GD32F170 5V Value Line	48MHz Frequency	Up to 64KB Flash	Up to 8KB SRAM		CAN 2.0B							
GD32F150 Value Line	72MHz Frequency	Up to 64KB Flash	Up to 8KB SRAM			HDMI-CEC	USB 2.0 FS	TSI				
GD32F130 Value Line	48MHz Frequency	Up to 64KB Flash	Up to 8KB SRAM									

New GD32F4, Leading Performance

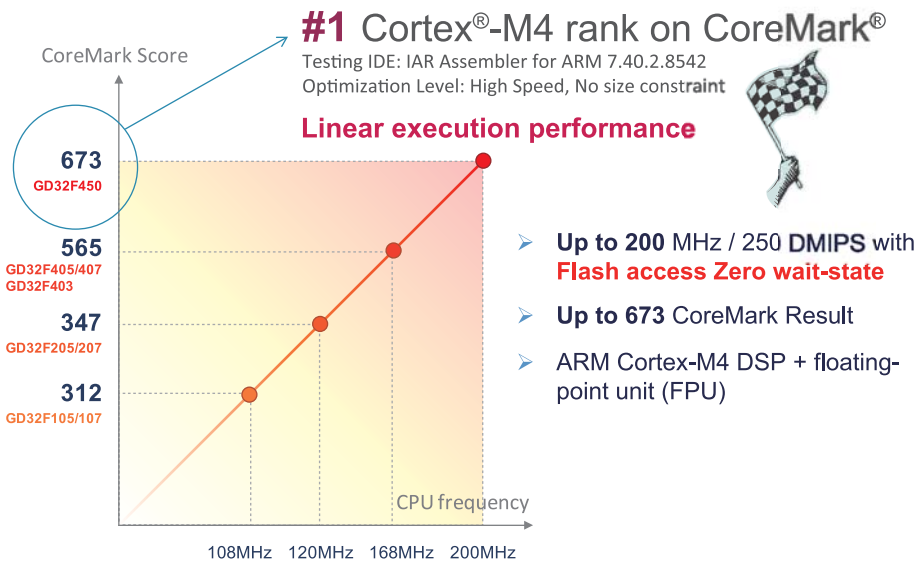

**Outstanding Value
Innovation Choice**





MCU Package Options

LQFP176 (24*24mm)	LQFP144 (20*20mm)	LQFP100 (14*14mm)	LQFP64 (10*10mm)	LQFP48 (7*7mm)	
					
BGA176 (10*10mm)	BGA100 (7*7mm)	QFN36 (6*6mm)	QFN32 (5*5mm)	QFN28 (4*4mm)	TSSOP20 (6.5*4.4mm)
					



GD32 Development Eco-system

Build GD32 development environment with H/W and S/W compatible



Product Line

Multiplex products

Best peripherals

Series compatible

Easy to use

Eco-system

Service

Sufficient Capacity

Fast lead time

High Performance

Cost-effective

Quality



GD32F3 series of 32-bit ARM® Cortex®-M4 MCUs Selection Guide



Series	Part No.	Max Speed (MHz)	Memory (Bytes)		I/O	Timer						Connectivity						Analog Interface		Package		
			Flash	SRAM		GPTM (16bit)	Advanced TM (16bit)	Basic TM (16bit)	SysTick (24bit)	WDG	RTC	USART +UART	I ² C	SPI	CAN 2.0B	USB 2.0 FS	I ² S	SDIO	Ether-net		EXMC	12bit ADC Units (CHs)
GD32F303	GD32F303CCT6	120	256K	48K	up to 37	4	1	2	1	2	1	3	2	3	2	3	1	1	2	3(10)	2	LQFP48
	GD32F303CET6	120	512K	64K	up to 37	4	1	2	1	2	1	3	2	3	2	3	1	1	2	3(10)	2	LQFP48
	GD32F303CGT6	120	1024K	96K	up to 37	10	1	2	1	2	1	3	2	3	2	3	1	1	2	3(10)	2	LQFP48
	GD32F303RCT6	120	256K	48K	up to 51	4	2	2	1	2	1	5	2	3	1	1	2	1	2	3(16)	2	LQFP64
	GD32F303RET6	120	512K	64K	up to 51	4	2	2	1	2	1	5	2	3	1	1	2	1	2	3(16)	2	LQFP64
	GD32F303RGT6	120	1024K	96K	up to 51	10	2	2	1	2	1	5	2	3	1	1	2	1	2	3(16)	2	LQFP64
	GD32F303RIT6	120	2048K	96K	up to 51	10	2	2	1	2	1	5	2	3	1	1	2	1	2	3(16)	2	LQFP64
	GD32F303RKT6	120	3072K	96K	up to 51	10	2	2	1	2	1	5	2	3	1	1	2	1	2	3(16)	2	LQFP64
	GD32F303VCT6	120	256K	48K	up to 80	4	2	2	1	2	1	5	2	3	1	1	2	1	2	3(16)	2	LQFP64
	GD32F303VET6	120	512K	64K	up to 80	4	2	2	1	2	1	5	2	3	1	1	2	1	2	3(16)	2	LQFP100
	GD32F303VGT6	120	1024K	96K	up to 80	10	2	2	1	2	1	5	2	3	1	1	2	1	2	3(16)	2	LQFP100
	GD32F303ZET6	120	2048K	96K	up to 80	10	2	2	1	2	1	5	2	3	1	1	2	1	2	3(16)	2	LQFP100
	GD32F303ZIT6	120	3072K	96K	up to 80	10	2	2	1	2	1	5	2	3	1	1	2	1	2	3(16)	2	LQFP100
	GD32F305RRT6	120	128K	64K	up to 51	4	1	2	1	2	1	5	2	3	1	1	2	1	2	2(16)	2	LQFP64
	GD32F305RCT6	120	256K	96K	up to 51	4	1	2	1	2	1	5	2	3	1	1	2	1	2	2(16)	2	LQFP64
	GD32F305RET6	120	512K	96K	up to 51	4	2	2	1	2	1	5	2	3	1	1	2	1	2	2(16)	2	LQFP64
GD32F305RGT6	120	1024K	96K	up to 51	10	2	2	1	2	1	5	2	3	1	1	2	1	2	2(16)	2	LQFP64	
GD32F305VCT6	120	256K	96K	up to 80	4	1	2	1	2	1	5	2	3	1	1	2	1	2	2(16)	2	LQFP100	
GD32F305VET6	120	512K	96K	up to 80	4	2	2	1	2	1	5	2	3	1	1	2	1	2	2(16)	2	LQFP100	
GD32F305VGT6	120	1024K	96K	up to 80	10	2	2	1	2	1	5	2	3	1	1	2	1	2	2(16)	2	LQFP100	
GD32F305ZCT6	120	256K	96K	up to 112	4	2	2	1	2	1	5	2	3	1	1	2	1	2	2(21)	2	LQFP144	
GD32F305ZET6	120	512K	96K	up to 112	4	2	2	1	2	1	5	2	3	1	1	2	1	2	2(21)	2	LQFP144	
GD32F305ZGT6	120	1024K	96K	up to 112	10	2	2	1	2	1	5	2	3	1	1	2	1	2	2(21)	2	LQFP144	
GD32F307RCT6	120	256K	96K	up to 51	4	1	2	1	2	1	5	2	3	2	2	2	2	2	2(16)	2	LQFP64	
GD32F307RET6	120	512K	96K	up to 51	4	2	2	1	2	1	5	2	3	2	2	2	2	2	2(16)	2	LQFP64	
GD32F307RGT6	120	1024K	96K	up to 51	10	2	2	1	2	1	5	2	3	2	2	2	2	2	2(16)	2	LQFP64	
GD32F307VCT6	120	256K	96K	up to 80	4	1	2	1	2	1	5	2	3	2	2	2	2	2	2(16)	2	LQFP100	
GD32F307VET6	120	512K	96K	up to 80	4	2	2	1	2	1	5	2	3	2	2	2	2	2	2(16)	2	LQFP100	
GD32F307VGT6	120	1024K	96K	up to 80	10	2	2	1	2	1	5	2	3	2	2	2	2	2	2(16)	2	LQFP100	
GD32F307ZCT6	120	256K	96K	up to 112	4	2	2	1	2	1	5	2	3	2	2	2	2	2	2(21)	2	LQFP144	
GD32F307ZET6	120	512K	96K	up to 112	4	2	2	1	2	1	5	2	3	2	2	2	2	2	2(21)	2	LQFP144	
GD32F307ZGT6	120	1024K	96K	up to 112	10	2	2	1	2	1	5	2	3	2	2	2	2	2	2(21)	2	LQFP144	

GD32F3 series of 32-bit ARM® Cortex®-M4 MCUs Selection Guide



Series	Part No.	Max Speed (MHz)	Memory (Bytes)		I/O	Timer				Connectivity						Analog Interface		Package			
			Flash	SRAM		GPTM (32bit)	GPTM (16bit)	Advanced TM (16bit)	Basic TM (16bit)	SysTick (24bit)	WDG	RTC	USART	I²C	SPI	USB 2.0 FS	I²S		CEC	Comp	12bit ADC Units (CHs)
GD32F30	GD32F30F4P6	84	16K	4K	up to 15	1	4	1		1	2	1	1	1	1				1(9)		TSSOP20
	GD32F30F6P6	84	32K	4K	up to 15	1	4	1		1	2	1	2	1	1				1(9)		TSSOP20
	GD32F30F8P6	84	64K	8K	up to 15	1	4	1		1	2	1	2	2	2				1(9)		TSSOP20
	GD32F30G4U6	84	16K	4K	up to 23	1	4	1		1	2	1	1	1	1				1(10)		QFN28
	GD32F30G6U6	84	32K	4K	up to 23	1	4	1		1	2	1	2	1	1				1(10)		QFN28
	GD32F30G8U6	84	64K	8K	up to 23	1	5	1		1	2	1	2	2	2				1(10)		QFN28
	GD32F30K4U6	84	16K	4K	up to 27	1	4	1		1	2	1	1	1	1				1(10)		QFN32
	GD32F30K6U6	84	32K	4K	up to 27	1	4	1		1	2	1	2	1	1				1(10)		QFN32
	GD32F30K8U6	84	64K	8K	up to 27	1	5	1		1	2	1	2	2	2				1(10)		QFN32
	GD32F30C4T6	84	16K	4K	up to 39	1	4	1		1	2	1	1	1	1				1(10)		LQFP48
	GD32F30C6T6	84	32K	4K	up to 39	1	4	1		1	2	1	2	1	1				1(10)		LQFP48
	GD32F30C8T6	84	64K	8K	up to 39	1	5	1		1	2	1	2	2	2				1(10)		LQFP48
	GD32F30CBT6	84	128K	16K	up to 39	1	5	1		1	2	1	2	2	2				1(10)		LQFP48
	GD32F30R8T6	84	64K	16K	up to 55	1	5	1		1	2	1	2	2	2				1(16)		LQFP64
	GD32F30R8T6	84	128K	16K	up to 55	1	5	1		1	2	1	2	2	2				1(16)		LQFP64
	GD32F350	GD32F350G4U6	108	16K	4K	up to 24	1	5	1	1	2	1	1	1	1	1	1	1	1	1(10)	1
GD32F350G6U6		108	32K	6K	up to 24	1	5	1	1	2	1	1	1	1	1	1	1	1	1(10)	1	QFN28
GD32F350G8U6		108	64K	8K	up to 24	1	5	1	1	2	1	1	1	1	1	1	1	1	1(10)	1	QFN28
GD32F350K4U6		108	16K	4K	up to 27	1	5	1	1	2	1	1	1	1	1	1	1	1	1(10)	1	QFN32
GD32F350K6U6		108	32K	6K	up to 27	1	5	1	1	2	1	1	1	1	1	1	1	1	1(10)	1	QFN32
GD32F350K8U6		108	64K	8K	up to 27	1	5	1	1	2	1	1	1	1	1	1	1	1	1(10)	1	QFN32
GD32F350C4T6		108	16K	4K	up to 39	1	5	1	1	1	2	1	1	1	1	1	1	1	1(10)	1	LQFP48
GD32F350C6T6		108	32K	6K	up to 39	1	5	1	1	1	2	1	1	1	1	1	1	1	1(10)	1	LQFP48
GD32F350C8T6		108	64K	8K	up to 39	1	5	1	1	1	2	1	1	1	1	1	1	1	1(10)	1	LQFP48
GD32F350CBT6		108	128K	16K	up to 39	1	5	1	1	1	2	1	1	1	1	1	1	1	1(10)	1	LQFP48
GD32F350R4T6		108	16K	4K	up to 55	1	5	1	1	1	2	1	1	1	1	1	1	1	1(16)	1	LQFP64
GD32F350R6T6		108	32K	8K	up to 55	1	5	1	1	1	2	1	1	1	1	1	1	1	1(16)	1	LQFP64
GD32F350R8T6		108	64K	16K	up to 55	1	5	1	1	1	2	1	1	1	1	1	1	1	1(16)	1	LQFP64
GD32F350R8T6		108	128K	16K	up to 55	1	5	1	1	1	2	1	1	1	1	1	1	1	1(16)	1	LQFP64

GD32F4 series of 32-bit ARM® Cortex®-M4F MCUs Selection Guide



Series	Part No.	Max Speed (MHz)	Memory (Bytes)		I/O	Timer				Connectivity							Analog Interface		Package							
			Flash	SRAM		GPTM (16bit) (16bit)	GPTM Adv TM (16bit) (16bit)	GPTM Bsc TM (32bit) (16bit)	WDG	RTC	USART +UART	I ² C	SPI	CAN 2.0B	USB OTG	i ² S	SDIO	LCD- TFT		Cam era	ETH MAC	IPA	EXMC/ SDRAM	12bit ADC Units (Chs)	12bit DAC Units	
GD32F450	GD32F450VET6	200	512K	256K	up to 82	8	2	2	2	2	1	4+4	3	5	2	FS+HS	2	1	1	1	1	1	1/0	3(16)	2	LQFP100
	GD32F450VGT6	200	1024K	256K	up to 82	8	2	2	2	2	1	4+4	3	5	2	FS+HS	2	1	1	1	1	1	1/0	3(16)	2	LQFP100
	GD32F450VIT6	200	2048K	512K	up to 82	8	2	2	2	2	1	4+4	3	5	2	FS+HS	2	1	1	1	1	1	1/0	3(16)	2	LQFP100
	GD32F450VKT6	200	3072K	256K	up to 82	8	2	2	2	2	1	4+4	3	5	2	FS+HS	2	1	1	1	1	1	1/0	3(16)	2	LQFP100
	GD32F450ZET6	200	512K	256K	up to 114	8	2	2	2	2	2	4+4	3	6	2	FS+HS	2	1	1	1	1	1	1/1	3(24)	2	LQFP144
	GD32F450ZGT6	200	1024K	256K	up to 114	8	2	2	2	2	2	4+4	3	6	2	FS+HS	2	1	1	1	1	1	1/1	3(24)	2	LQFP144
	GD32F450ZKT6	200	2048K	512K	up to 114	8	2	2	2	2	2	4+4	3	6	2	FS+HS	2	1	1	1	1	1	1/1	3(24)	2	LQFP144
	GD32F450ZHT6	200	3072K	256K	up to 140	8	2	2	2	2	2	4+4	3	6	2	FS+HS	2	1	1	1	1	1	1/1	3(24)	2	BGA176
	GD32F450IHT6	200	2048K	512K	up to 140	8	2	2	2	2	2	4+4	3	6	2	FS+HS	2	1	1	1	1	1	1/1	3(24)	2	BGA176
	GD32F450IHT6	200	3072K	256K	up to 140	8	2	2	2	2	2	4+4	3	6	2	FS+HS	2	1	1	1	1	1	1/1	3(24)	2	BGA176
	GD32F405RET6	168	512K	192K	up to 51	8	2	2	2	2	2	4+2	3	3	2	FS+HS	2	1	1	1	1	1	1/1	3(16)	2	LQFP64
	GD32F405RGT6	168	1024K	192K	up to 51	8	2	2	2	2	2	4+2	3	3	2	FS+HS	2	1	1	1	1	1	1/1	3(16)	2	LQFP64
	GD32F405RKT6	168	3072K	192K	up to 51	8	2	2	2	2	2	4+2	3	3	2	FS+HS	2	1	1	1	1	1	1/1	3(16)	2	LQFP64
	GD32F405VGT6	168	1024K	192K	up to 82	8	2	2	2	2	2	4+2	3	3	2	FS+HS	2	1	1	1	1	1	1/1	3(16)	2	LQFP100
	GD32F405VKT6	168	3072K	192K	up to 82	8	2	2	2	2	2	4+2	3	3	2	FS+HS	2	1	1	1	1	1	1/1	3(16)	2	LQFP100
	GD32F405VGH6	168	1024K	192K	up to 82	8	2	2	2	2	2	4+2	3	3	2	FS+HS	2	1	1	1	1	1	1/1	3(16)	2	BGA100
GD32F405VKH6	168	3072K	192K	up to 82	8	2	2	2	2	2	4+2	3	3	2	FS+HS	2	1	1	1	1	1	1/1	3(16)	2	BGA100	
GD32F405ZGT6	168	1024K	192K	up to 114	8	2	2	2	2	2	4+2	3	3	2	FS+HS	2	1	1	1	1	1	1/0	3(16)	2	LQFP144	
GD32F405ZKT6	168	3072K	192K	up to 114	8	2	2	2	2	2	4+2	3	3	2	FS+HS	2	1	1	1	1	1	1/0	3(16)	2	LQFP144	
GD32F407RET6	168	512K	192K	up to 51	8	2	2	2	2	2	4+2	3	3	2	FS+HS	2	1	1	1	1	1	1/1	3(16)	2	LQFP64	
GD32F407RGT6	168	1024K	192K	up to 51	8	2	2	2	2	2	4+2	3	3	2	FS+HS	2	1	1	1	1	1	1/1	3(16)	2	LQFP64	
GD32F407RKT6	168	3072K	192K	up to 51	8	2	2	2	2	2	4+2	3	3	2	FS+HS	2	1	1	1	1	1	1/1	3(16)	2	LQFP64	
GD32F407VET6	168	512K	192K	up to 82	8	2	2	2	2	2	4+2	3	3	2	FS+HS	2	1	1	1	1	1	1/0	3(16)	2	LQFP100	
GD32F407VGT6	168	1024K	192K	up to 82	8	2	2	2	2	2	4+2	3	3	2	FS+HS	2	1	1	1	1	1	1/0	3(16)	2	LQFP100	
GD32F407VKT6	168	3072K	192K	up to 82	8	2	2	2	2	2	4+2	3	3	2	FS+HS	2	1	1	1	1	1	1/0	3(16)	2	LQFP100	
GD32F407VEH6	168	512K	192K	up to 82	8	2	2	2	2	2	4+2	3	3	2	FS+HS	2	1	1	1	1	1	1/0	3(16)	2	BGA100	
GD32F407VGH6	168	1024K	192K	up to 82	8	2	2	2	2	2	4+2	3	3	2	FS+HS	2	1	1	1	1	1	1/0	3(16)	2	BGA100	
GD32F407VKH6	168	3072K	192K	up to 82	8	2	2	2	2	2	4+2	3	3	2	FS+HS	2	1	1	1	1	1	1/0	3(16)	2	BGA100	
GD32F407ZET6	168	512K	192K	up to 114	8	2	2	2	2	2	4+2	3	3	2	FS+HS	2	1	1	1	1	1	1/1	3(24)	2	LQFP144	
GD32F407ZGT6	168	1024K	192K	up to 114	8	2	2	2	2	2	4+2	3	3	2	FS+HS	2	1	1	1	1	1	1/1	3(24)	2	LQFP144	
GD32F407ZKT6	168	3072K	192K	up to 114	8	2	2	2	2	2	4+2	3	3	2	FS+HS	2	1	1	1	1	1	1/1	3(24)	2	LQFP144	
GD32F407IEH6	168	512K	192K	up to 140	8	2	2	2	2	2	4+2	3	3	2	FS+HS	2	1	1	1	1	1	1/1	3(24)	2	BGA176	
GD32F407IGH6	168	1024K	192K	up to 140	8	2	2	2	2	2	4+2	3	3	2	FS+HS	2	1	1	1	1	1	1/1	3(24)	2	BGA176	
GD32F407IKH6	168	3072K	192K	up to 140	8	2	2	2	2	2	4+2	3	3	2	FS+HS	2	1	1	1	1	1	1/1	3(24)	2	BGA176	



GD32F4 series of 32-bit ARM® Cortex®-M4F MCUs Selection Guide

Series	Part No.	Max Speed (MHz)	Memory (Bytes)		I/O	Timer								Connectivity										Analog Interface		Package		
			Flash	SRAM		GPTM (16bit)	Adv TM (16bit)	GPTM (32bit)	Bsc TM (16bit)	WDBG	RTC	USART +UART	I ² C	SPI	CAN 2.0B	USB OTG	I ² S	SDIO	LCD-TFT	Camera	ETH MAC	IPA	EXMC/SDRAM	12bit ADC Units (CHs)	12bit DAC Units			
GD32F403	GD32F403RCT6	168	256K	64K	up to 51	8	2			2	2	1	3+2	2	3	2	2	OTG	2	1					0/0	3(16)	2	LQFP64
	GD32F403RET6	168	512K	96K	up to 51	8	2			2	2	1	3+2	2	3	2	2	OTG	2	1					0/0	3(16)	2	LQFP64
	GD32F403RGT6	168	1024K	128K	up to 51	8	2			2	2	1	3+2	2	3	2	2	OTG	2	1					0/0	3(16)	2	LQFP64
	GD32F403RIT6	168	2048K	128K	up to 51	8	2			2	2	1	3+2	2	3	2	2	OTG	2	1					0/0	3(16)	2	LQFP64
	GD32F403RKT6	168	3072K	128K	up to 51	8	2			2	2	1	3+2	2	3	2	2	OTG	2	1					0/0	3(16)	2	LQFP64
	GD32F403VCT6	168	256K	64K	up to 80	8	2			2	2	1	3+2	2	3	2	2	OTG	2	1					1/0	3(16)	2	LQFP100
	GD32F403VET6	168	512K	96K	up to 80	8	2			2	2	1	3+2	2	3	2	2	OTG	2	1					1/0	3(16)	2	LQFP100
	GD32F403VGT6	168	1024K	128K	up to 80	8	2			2	2	1	3+2	2	3	2	2	OTG	2	1					1/0	3(16)	2	LQFP100
	GD32F403VIT6	168	2048K	128K	up to 80	8	2			2	2	1	3+2	2	3	2	2	OTG	2	1					1/0	3(16)	2	LQFP100
	GD32F403VKT6	168	3072K	128K	up to 80	8	2			2	2	1	3+2	2	3	2	2	OTG	2	1					1/0	3(16)	2	LQFP100
	GD32F403VCH6	168	256K	64K	up to 80	8	2			2	2	1	3+2	2	3	2	2	OTG	2	1					1/0	3(16)	2	BGA100
	GD32F403VEH6	168	512K	96K	up to 80	8	2			2	2	1	3+2	2	3	2	2	OTG	2	1					1/0	3(16)	2	BGA100
	GD32F403VGH6	168	1024K	128K	up to 80	8	2			2	2	1	3+2	2	3	2	2	OTG	2	1					1/0	3(16)	2	BGA100
	GD32F403VHH6	168	2048K	128K	up to 80	8	2			2	2	1	3+2	2	3	2	2	OTG	2	1					1/0	3(16)	2	BGA100
	GD32F403VKH6	168	3072K	128K	up to 80	8	2			2	2	1	3+2	2	3	2	2	OTG	2	1					1/0	3(16)	2	BGA100
	GD32F403ZCT6	168	256K	64K	up to 112	8	2			2	2	1	3+2	2	3	2	2	OTG	2	1					1/0	3(21)	2	LQFP144
	GD32F403ZET6	168	512K	96K	up to 112	8	2			2	2	1	3+2	2	3	2	2	OTG	2	1					1/0	3(21)	2	LQFP144
	GD32F403ZGT6	168	1024K	128K	up to 112	8	2			2	2	1	3+2	2	3	2	2	OTG	2	1					1/0	3(21)	2	LQFP144
	GD32F403ZIT6	168	2048K	128K	up to 112	8	2			2	2	1	3+2	2	3	2	2	OTG	2	1					1/0	3(21)	2	LQFP144
	GD32F403ZKT6	168	3072K	128K	up to 112	8	2			2	2	1	3+2	2	3	2	2	OTG	2	1					1/0	3(21)	2	LQFP144

GD32F2 series of 32-bit ARM® Cortex®-M3 MCUs Selection Guide



Series	Part No.	Max Speed (MHz)	Memory (Bytes)		I/O	Timer				Connectivity							Analog Interface		Package									
			Flash	SRAM		GPTM (16bit)	Adv TM (16bit)	Bsc TM (16bit)	SysTick (24bit)	WdG RTC	USART +UART	I²C	SPI	CAN 2.0B	USB 2.0 FS	I²S	SDIO	LCD-TFT		Cam era	ETH MAC	Crypto/ Hash	EXMC/ SDRAM	12bit ADC Units (CHs)	12bit DAC Units			
GD32F205	GD32F205RCT6	120	256K	128K	up to 51	10	2	2	1	2	1	2	1	4+2	3	3	2	2	OTG	2	1				3(16)	2	LQFP64	
	GD32F205RET6	120	512K	128K	up to 51	10	2	2	1	2	1	2	1	4+2	3	3	2	2	OTG	2	1				3(16)	2	LQFP64	
	GD32F205RGT6	120	1024K	256K	up to 51	10	2	2	1	2	1	2	1	4+2	3	3	2	2	OTG	2	1				3(16)	2	LQFP64	
	GD32F205RKT6	120	3072K	256K	up to 51	10	2	2	1	2	1	2	1	4+2	3	3	2	2	OTG	2	1				3(16)	2	LQFP64	
	GD32F205VCT6	120	256K	128K	up to 82	10	2	2	1	2	1	2	1	4+4	3	3	2	2	OTG	2	1	1	1		3(16)	2	LQFP100	
	GD32F205VET6	120	512K	128K	up to 82	10	2	2	1	2	1	2	1	4+4	3	3	2	2	OTG	2	1	1	1		3(16)	2	LQFP100	
	GD32F205VGT6	120	1024K	256K	up to 82	10	2	2	1	2	1	2	1	4+4	3	3	2	2	OTG	2	1	1	1		3(16)	2	LQFP100	
	GD32F205VKT6	120	3072K	256K	up to 82	10	2	2	1	2	1	2	1	4+4	3	3	2	2	OTG	2	1	1	1		3(16)	2	LQFP100	
	GD32F205ZCT6	120	256K	128K	up to 114	10	2	2	1	2	1	2	1	4+4	3	3	2	2	OTG	2	1	1	1		3(24)	2	LQFP144	
	GD32F205ZET6	120	512K	128K	up to 114	10	2	2	1	2	1	2	1	4+4	3	3	2	2	OTG	2	1	1	1		3(24)	2	LQFP144	
	GD32F205ZGT6	120	1024K	256K	up to 114	10	2	2	1	2	1	2	1	4+4	3	3	2	2	OTG	2	1	1	1		3(24)	2	LQFP144	
	GD32F205ZKT6	120	3072K	256K	up to 114	10	2	2	1	2	1	2	1	4+4	3	3	2	2	OTG	2	1	1	1		3(24)	2	LQFP144	
	GD32F207RCT6	120	256K	128K	up to 51	10	2	2	1	2	1	2	1	4+2	3	3	2	2	OTG	2	1	1	1	1	1	3(16)	2	LQFP64
	GD32F207RET6	120	512K	128K	up to 51	10	2	2	1	2	1	2	1	4+2	3	3	2	2	OTG	2	1	1	1	1	1	3(16)	2	LQFP64
	GD32F207RGT6	120	1024K	256K	up to 51	10	2	2	1	2	1	2	1	4+2	3	3	2	2	OTG	2	1	1	1	1	1	3(16)	2	LQFP64
	GD32F207RKT6	120	3072K	256K	up to 51	10	2	2	1	2	1	2	1	4+2	3	3	2	2	OTG	2	1	1	1	1	1	3(16)	2	LQFP64
GD32F207VCT6	120	256K	128K	up to 82	10	2	2	1	2	1	2	1	4+4	3	3	2	2	OTG	2	1	1	1	1	1	3(16)	2	LQFP100	
GD32F207VET6	120	512K	128K	up to 82	10	2	2	1	2	1	2	1	4+4	3	3	2	2	OTG	2	1	1	1	1	1	3(16)	2	LQFP100	
GD32F207VGT6	120	1024K	256K	up to 82	10	2	2	1	2	1	2	1	4+4	3	3	2	2	OTG	2	1	1	1	1	1	3(16)	2	LQFP100	
GD32F207VKT6	120	3072K	256K	up to 82	10	2	2	1	2	1	2	1	4+4	3	3	2	2	OTG	2	1	1	1	1	1	3(16)	2	LQFP100	
GD32F207ZCT6	120	256K	128K	up to 114	10	2	2	1	2	1	2	1	4+4	3	3	2	2	OTG	2	1	1	1	1	1	3(24)	2	LQFP144	
GD32F207ZET6	120	512K	128K	up to 114	10	2	2	1	2	1	2	1	4+4	3	3	2	2	OTG	2	1	1	1	1	1	3(24)	2	LQFP144	
GD32F207ZGT6	120	1024K	256K	up to 114	10	2	2	1	2	1	2	1	4+4	3	3	2	2	OTG	2	1	1	1	1	1	3(24)	2	LQFP144	
GD32F207ZKT6	120	3072K	256K	up to 114	10	2	2	1	2	1	2	1	4+4	3	3	2	2	OTG	2	1	1	1	1	1	3(24)	2	LQFP144	
GD32F207IET6	120	512K	128K	up to 140	10	2	2	1	2	1	2	1	4+4	3	3	2	2	OTG	2	1	1	1	1	1	3(24)	2	LQFP176	
GD32F207IGT6	120	1024K	256K	up to 140	10	2	2	1	2	1	2	1	4+4	3	3	2	2	OTG	2	1	1	1	1	1	3(24)	2	LQFP176	
GD32F207IKT6	120	3072K	256K	up to 140	10	2	2	1	2	1	2	1	4+4	3	3	2	2	OTG	2	1	1	1	1	1	3(24)	2	LQFP176	

GD32F207



GD32F1 series of 32-bit ARM® Cortex®-M3 MCUs Selection Guide

Series	Part No.	Max Speed (MHz)	Memory (Bytes)		I/O	Timer				Connectivity				Analog Interface		Package						
			Flash	SRAM		GPTM (32bit)	GPTM (16bit)	Advanced TM (16bit)	Basic TM (16bit)	SysTick (24bit)	WDG	RTC	USART	I²C	SPI		USB 2.0 FS	i²S	CEC	12bit ADC Units (CHs)	12bit DAC Units	
GD32F130	GD32F130F4P6	48	16K	4K	up to 15	1	4	1	1	2	1	1	1	1	1	1	1(9)		TSSOP20			
	GD32F130F6P6	48	32K	4K	up to 15	1	4	1	1	2	1	2	1	1	1	1	1(9)		TSSOP20			
	GD32F130F8P6	48	64K	8K	up to 15	1	4	1	1	2	1	2	2	2	2	2	1(9)		TSSOP20			
	GD32F130G4U6	48	16K	4K	up to 23	1	4	1	1	2	1	1	1	1	1	1	1(10)		QFN28			
	GD32F130G6U6	48	32K	4K	up to 23	1	4	1	1	2	1	2	1	1	1	1	1(10)		QFN28			
	GD32F130G8U6	48	64K	8K	up to 23	1	5	1	1	2	1	2	2	2	2	2	1(10)		QFN28			
	GD32F130K4U6	48	16K	4K	up to 27	1	4	1	1	2	1	1	1	1	1	1	1(10)		QFN32			
	GD32F130K6U6	48	32K	4K	up to 27	1	4	1	1	2	1	2	1	1	1	1	1(10)		QFN32			
	GD32F130K8U6	48	64K	8K	up to 27	1	5	1	1	2	1	2	2	2	2	2	1(10)		QFN32			
	GD32F130C4T6	48	16K	4K	up to 39	1	4	1	1	2	1	1	1	1	1	1	1(10)		LQFP48			
	GD32F130C6T6	48	32K	4K	up to 39	1	4	1	1	2	1	2	1	1	1	1	1(10)		LQFP48			
	GD32F130C8T6	48	64K	8K	up to 39	1	5	1	1	2	1	2	2	2	2	2	1(10)		LQFP48			
	GD32F130R8T6	48	64K	8K	up to 55	1	5	1	1	2	1	2	2	2	2	2	1(16)		LQFP64			
	GD32F150G4U6	72	16K	4K	up to 24	1	5	1	1	1	2	1	1	1	1	1	1(10)	1	QFN28			
	GD32F150G6U6	72	32K	6K	up to 24	1	5	1	1	2	1	2	1	1	1	1	1(10)	1	QFN28			
GD32F150G8U6	72	64K	8K	up to 24	1	5	1	1	2	1	2	2	2	2	2	1(10)	1	QFN28				
GD32F150K4U6	72	16K	4K	up to 27	1	5	1	1	2	1	1	1	1	1	1	1(10)	1	QFN32				
GD32F150K6U6	72	32K	6K	up to 27	1	5	1	1	2	1	2	1	1	1	1	1(10)	1	QFN32				
GD32F150K8U6	72	64K	8K	up to 27	1	5	1	1	2	1	2	2	2	2	2	1(10)	1	QFN32				
GD32F150C4T6	72	16K	4K	up to 39	1	5	1	1	2	1	1	1	1	1	1	1(10)	1	LQFP48				
GD32F150C6T6	72	32K	6K	up to 39	1	5	1	1	2	1	2	1	1	1	1	1(10)	1	LQFP48				
GD32F150C8T6	72	64K	8K	up to 39	1	5	1	1	2	1	2	2	2	2	2	1(10)	1	LQFP48				
GD32F150R4T6	72	16K	4K	up to 55	1	5	1	1	2	1	1	1	1	1	1	1(16)	1	LQFP64				
GD32F150R6T6	72	32K	6K	up to 55	1	5	1	1	2	1	2	1	1	1	1	1(16)	1	LQFP64				
GD32F150R8T6	72	64K	8K	up to 55	1	5	1	1	2	1	2	2	2	2	2	1(16)	1	LQFP64				
Series	Part No.	Max Speed (MHz)	Memory (Bytes)		I/O	Timer				Connectivity				Analog Interface		Package						
			Flash	SRAM		GPTM (32bit)	GPTM (16bit)	Advanced TM (16bit)	Basic TM (16bit)	SysTick (24bit)	WDG	RTC	USART	I²C	SPI		CAN 2.0B	i²S	LCD	OP-amp	Comp	12bit ADC Units (CHs)
GD32F170	GD32F170T4U6	48	16K	4K	up to 28	1	4	1	1	2	1	1	1	1	1	1	1	1	1	1(10)		QFN36
	GD32F170T6U6	48	32K	4K	up to 28	1	4	1	1	2	1	2	1	2	1	2	1	1	1	1(10)		QFN36
	GD32F170T8U6	48	64K	8K	up to 28	1	5	1	1	2	1	2	3	3	2	2	1	1	1	1(10)		QFN36
	GD32F170C4T6	48	16K	4K	up to 39	1	4	1	1	2	1	1	1	1	1	1	1	1	1	1(10)		LQFP48
	GD32F170C6T6	48	32K	4K	up to 39	1	4	1	1	2	1	2	1	1	1	1	1	1	1	1(10)		LQFP48
	GD32F170C8T6	48	64K	8K	up to 39	1	5	1	1	2	1	2	3	3	2	2	2	1	1	1(10)		LQFP48
GD32F190	GD32F170R8T6	48	64K	8K	up to 55	1	5	1	1	2	1	2	3	3	2	2	1	1	1	1(16)		LQFP64
	GD32F190T4U6	72	16K	4K	up to 28	1	5	1	1	2	1	2	1	2	1	2	1	1	2	1(10)	2	QFN36
	GD32F190T6U6	72	32K	6K	up to 28	1	5	1	1	2	1	2	1	2	1	2	2	2	2	1(10)	2	QFN36
	GD32F190T8U6	72	64K	8K	up to 28	1	5	1	1	2	1	2	3	3	2	2	2	2	2	1(10)	2	QFN36
	GD32F190C4T6	72	16K	4K	up to 39	1	5	1	1	2	1	1	1	1	1	1	1	1	1	1(10)	2	LQFP48
	GD32F190C6T6	72	32K	6K	up to 39	1	5	1	1	2	1	2	1	1	1	1	1	1	1	1(10)	2	LQFP48
GD32F190C8T6	72	64K	8K	up to 39	1	5	1	1	2	1	2	3	3	2	2	2	2	2	1(10)	2	LQFP48	
GD32F190R4T6	72	16K	4K	up to 55	1	5	1	1	2	1	1	1	1	1	1	1	1	1	1(16)	2	LQFP64	
GD32F190R6T6	72	32K	6K	up to 55	1	5	1	1	2	1	2	1	1	1	1	1	1	1	1(16)	2	LQFP64	
GD32F190R8T6	72	64K	8K	up to 55	1	5	1	1	2	1	2	3	3	2	2	2	2	2	1(16)	2	LQFP64	

GD32F1 series of 32-bit ARM® Cortex®-M3 MCUs Selection Guide



Series	Part No.	Max Speed (MHz)	Memory (Bytes)		I/O	Timer						Connectivity						Analog Interface		Package	
			Flash	SRAM		GPTM (16bit)	Advanced TM (16bit)	Basic TM (16bit)	SysTick (24bit)	WDG	RTC	USART (UART)	I ² C	SPI	CAN 2.0B	USB 2.0 FS	I ² S	SDIO	Ethernet		EXMC
GD32F103	GD32F103T4U6	108	16K	6K	up to 26	2	1	1	1	2	1	2	1	2	1	1	1	1	2(10)		QFN36
	GD32F103T6U6	108	32K	10K	up to 26	2	1	1	1	2	1	2	1	2	1	1	1	1	2(10)		QFN36
	GD32F103T8U6	108	64K	20K	up to 26	3	1	1	1	2	1	2	1	2	1	1	1	1	2(10)		QFN36
	GD32F103TBU6	108	128K	20K	up to 26	3	1	1	1	2	1	2	1	2	1	1	1	1	2(10)		QFN36
	GD32F103C4T6	108	16K	6K	up to 37	2	1	1	1	2	1	2	1	2	1	1	1	1	2(10)		LQFP48
	GD32F103C6T6	108	32K	10K	up to 37	2	1	1	1	2	1	2	1	2	1	1	1	1	2(10)		LQFP48
	GD32F103C8T6	108	64K	20K	up to 37	3	1	1	1	2	1	2	1	2	1	1	1	1	2(10)		LQFP48
	GD32F103CBT6	108	128K	20K	up to 37	3	1	1	1	2	1	2	1	2	1	1	1	1	2(10)		LQFP48
	GD32F103R4T6	108	16K	6K	up to 51	2	1	1	1	2	1	2	1	2	1	1	1	1	2(16)		LQFP64
	GD32F103R6T6	108	32K	10K	up to 51	2	1	1	1	2	1	2	1	2	1	1	1	1	2(16)		LQFP64
	GD32F103R8T6	108	64K	20K	up to 51	3	1	1	1	2	1	2	1	2	1	1	1	1	2(16)		LQFP64
	GD32F103RBT6	108	128K	20K	up to 51	3	1	1	1	2	1	2	1	2	1	1	1	1	2(16)		LQFP64
	GD32F103RCT6	108	256K	48K	up to 51	4	2	2	2	2	1	2	1	2	1	2	3	1	3(16)	2	LQFP64
	GD32F103RDT6	108	384K	64K	up to 51	4	2	2	2	2	1	2	1	2	1	2	3	1	3(16)	2	LQFP64
	GD32F103RET6	108	512K	64K	up to 51	4	2	2	2	2	1	2	1	2	1	2	3	1	3(16)	2	LQFP64
	GD32F103RFT6	108	768K	96K	up to 51	10	2	2	2	2	1	2	1	2	1	2	3	1	3(16)	2	LQFP64
	GD32F103RGT6	108	1024K	96K	up to 51	10	2	2	2	2	1	2	1	2	1	2	3	1	3(16)	2	LQFP64
	GD32F103RIT6	108	2048K	96K	up to 51	10	2	2	2	2	1	2	1	2	1	2	3	1	3(16)	2	LQFP64
	GD32F103RKT6	108	3072K	96K	up to 51	10	2	2	2	2	1	2	1	2	1	2	3	1	3(16)	2	LQFP64
	GD32F103V8T6	108	64K	20K	up to 80	3	1	1	1	2	1	2	1	2	1	2	2	2	2(16)		LQFP100
	GD32F103VBT6	108	128K	20K	up to 80	3	1	1	1	2	1	2	1	2	1	2	2	2	2(16)		LQFP100
	GD32F103VCT6	108	256K	48K	up to 80	4	2	2	2	2	1	2	1	2	1	2	3	1	3(16)	2	LQFP100
	GD32F103VDT6	108	384K	64K	up to 80	4	2	2	2	2	1	2	1	2	1	2	3	1	3(16)	2	LQFP100
	GD32F103VET6	108	512K	64K	up to 80	4	2	2	2	2	1	2	1	2	1	2	3	1	3(16)	2	LQFP100
	GD32F103VFT6	108	768K	96K	up to 80	10	2	2	2	2	1	2	1	2	1	2	3	1	3(16)	2	LQFP100
	GD32F103VGT6	108	1024K	96K	up to 80	10	2	2	2	2	1	2	1	2	1	2	3	1	3(16)	2	LQFP100
	GD32F103VIT6	108	2048K	96K	up to 80	10	2	2	2	2	1	2	1	2	1	2	3	1	3(16)	2	LQFP100
	GD32F103VKT6	108	3072K	96K	up to 80	10	2	2	2	2	1	2	1	2	1	2	3	1	3(16)	2	LQFP100
	GD32F103ZCT6	108	256K	48K	up to 112	4	2	2	2	2	1	2	1	2	1	2	3	1	3(21)	2	LQFP144
	GD32F103ZDT6	108	384K	64K	up to 112	4	2	2	2	2	1	2	1	2	1	2	3	1	3(21)	2	LQFP144
	GD32F103ZET6	108	512K	64K	up to 112	4	2	2	2	2	1	2	1	2	1	2	3	1	3(21)	2	LQFP144
	GD32F103ZFT6	108	768K	96K	up to 112	10	2	2	2	2	1	2	1	2	1	2	3	1	3(21)	2	LQFP144
GD32F103ZGT6	108	1024K	96K	up to 112	10	2	2	2	2	1	2	1	2	1	2	3	1	3(21)	2	LQFP144	
GD32F103ZIT6	108	2048K	96K	up to 112	10	2	2	2	2	1	2	1	2	1	2	3	1	3(21)	2	LQFP144	
GD32F103ZKT6	108	3072K	96K	up to 112	10	2	2	2	2	1	2	1	2	1	2	3	1	3(21)	2	LQFP144	

GD32F1 series of 32-bit ARM® Cortex®-M3 MCUs Selection Guide



Series	Part No.	Max Speed (MHz)	Memory (Bytes)		I/O	Timer						Connectivity					Analog Interface		Package		
			Flash	SRAM		GPTM (16bit)	Advanced TM (16bit)	Basic TM (16bit)	SysTick (24bit)	WDG	RTC	USART (UART)	I ² C	SPI	CAN 2.0B	USB 2.0 FS	I ² S	SDIO		Ethernet	EXMC
	GD32F101T4U6	56	16K	4K	up to 26	2			1	2	1	2	1	1					1(10)		QFN36
	GD32F101T6U6	56	32K	6K	up to 26	2			1	2	1	2	1	1					1(10)		QFN36
	GD32F101T8U6	56	64K	10K	up to 26	3			1	2	1	2	1	1					1(10)		QFN36
	GD32F101TBU6	56	128K	16K	up to 26	3			1	2	1	2	1	1					1(10)		QFN36
	GD32F101C4T6	56	16K	4K	up to 37	2			1	2	1	2	1	1					1(10)		LQFP48
	GD32F101C6T6	56	32K	6K	up to 37	2			1	2	1	2	1	1					1(10)		LQFP48
	GD32F101C8T6	56	64K	10K	up to 37	3			1	2	1	3	2	2					1(10)		LQFP48
	GD32F101CBT6	56	128K	16K	up to 37	3			1	2	1	3	2	2					1(10)		LQFP48
	GD32F101R4T6	56	16K	4K	up to 51	2			1	2	1	2	1	1					1(16)		LQFP64
	GD32F101R6T6	56	32K	6K	up to 51	2			1	2	1	2	1	1					1(16)		LQFP64
	GD32F101R8T6	56	64K	10K	up to 51	3			1	2	1	3	2	2					1(16)		LQFP64
	GD32F101RBT6	56	128K	16K	up to 51	3			1	2	1	3	2	2					1(16)		LQFP64
	GD32F101RCT6	56	256K	32K	up to 51	4			2	1	2	1	5	2	3				1(16)	2	LQFP64
	GD32F101RDT6	56	384K	48K	up to 51	4			2	1	2	1	5	2	3				1(16)	2	LQFP64
	GD32F101RET6	56	512K	48K	up to 51	4			2	1	2	1	5	2	3				1(16)	2	LQFP64
	GD32F101RFT6	56	768K	80K	up to 51	10			2	1	2	1	5	2	3				2(16)	2	LQFP64
	GD32F101RGT6	56	1024K	80K	up to 51	10			2	1	2	1	5	2	3				2(16)	2	LQFP64
	GD32F101RIT6	56	2048K	80K	up to 51	10			2	1	2	1	5	2	3				2(16)	2	LQFP64
	GD32F101RKT6	56	3072K	80K	up to 51	10			2	1	2	1	5	2	3				2(16)	2	LQFP64
	GD32F101V8T6	56	64K	10K	up to 80	3			1	2	1	3	2	2					1(16)		LQFP100
	GD32F101VBT6	56	128K	16K	up to 80	3			1	2	1	3	2	2					1(16)		LQFP100
	GD32F101VCT6	56	256K	32K	up to 80	4			2	1	2	1	5	2	3				1(16)	2	LQFP100
	GD32F101VDT6	56	384K	48K	up to 80	4			2	1	2	1	5	2	3				1(16)	2	LQFP100
	GD32F101VET6	56	512K	48K	up to 80	4			2	1	2	1	5	2	3				1(16)	2	LQFP100
	GD32F101VFT6	56	768K	80K	up to 80	10			2	1	2	1	5	2	3				2(16)	2	LQFP100
	GD32F101VGT6	56	1024K	80K	up to 80	10			2	1	2	1	5	2	3				2(16)	2	LQFP100
	GD32F101VIT6	56	2048K	80K	up to 80	10			2	1	2	1	5	2	3				2(16)	2	LQFP100
	GD32F101VKT6	56	3072K	80K	up to 80	10			2	1	2	1	5	2	3				2(16)	2	LQFP100
	GD32F101ZCT6	56	256K	32K	up to 112	4			2	1	2	1	5	2	3				1(16)	2	LQFP144
	GD32F101ZDT6	56	384K	48K	up to 112	4			2	1	2	1	5	2	3				1(16)	2	LQFP144
	GD32F101ZET6	56	512K	48K	up to 112	4			2	1	2	1	5	2	3				1(16)	2	LQFP144
	GD32F101ZFT6	56	768K	80K	up to 112	10			2	1	2	1	5	2	3				2(16)	2	LQFP144
	GD32F101ZGT6	56	1024K	80K	up to 112	10			2	1	2	1	5	2	3				2(16)	2	LQFP144
	GD32F101ZIT6	56	2048K	80K	up to 112	10			2	1	2	1	5	2	3				2(16)	2	LQFP144
	GD32F101ZKT6	56	3072K	80K	up to 112	10			2	1	2	1	5	2	3				2(16)	2	LQFP144

GD32F101

SPI NOR Flash

GD SPI NOR Flash Features

3.0V	2.5V	1.8V
<ul style="list-style-type: none"> ◆ Single Power Supply Voltage <ul style="list-style-type: none"> - Voltage range: 2.7V~3.6V ◆ High Speed Clock Frequency <ul style="list-style-type: none"> - Maximum 120MHz for fast read with 30pF load* - Dual I/O Data transfer up to 240Mbits/s - Quad I/O Data transfer up to 480Mbits/s - Continuous Read With 8/16/32/64-Byte Wrap ◆ Flexible Memory Architecture <ul style="list-style-type: none"> - Sector Size: 4K Bytes - Block Size: 32/64K Bytes 	<ul style="list-style-type: none"> ◆ Single Power Supply Voltage <ul style="list-style-type: none"> - Voltage range: 2.3V~3.6V ◆ High Speed Clock Frequency <ul style="list-style-type: none"> - Maximum 104MHz for fast read with 30pF load** - Dual I/O Data transfer up to 208Mbits/s - Quad I/O Data transfer up to 416Mbits/s - Continuous Read With 8/16/32/64-Byte Wrap ◆ Flexible Memory Architecture <ul style="list-style-type: none"> - Sector Size: 4K Bytes - Block Size: 32/64K Bytes 	<ul style="list-style-type: none"> ◆ Single Power Supply Voltage <ul style="list-style-type: none"> - Voltage range: 1.65V~2.0V ◆ High Speed Clock Frequency <ul style="list-style-type: none"> - 120MHz for fast read with 30pF load*** - Dual I/O Data transfer up to 240MHZ - Quad I/O Data transfer up to 480Mbits/s - QPI Data transfer up to 480Mbits/s - Continuous Read With 8/16/32/64-Byte Wrap ◆ Flexible Memory Architecture <ul style="list-style-type: none"> - Sector Size: 4K Bytes - Block Size: 32/64K Bytes

* This feature is available on most of devices. Please refer to page 12-13.
 ** This Feature is available on most of devices. Please refer to Page 12-13.
 *** This Feature is available on most of devices. Please refer to Page 12-13.

GD SPI NOR Flash Example

<p>Company Prefix GD: GigaDevice</p> <p>Product Family 25: SPI Interface Flash</p> <p>Series Q/B/M: 3V, Quad I/O VQ/VE/VH: 2.5V, Quad I/O LQ/LE/LB/LH: 1.8V, Quad I/O D: 3V, Dual I/O VD: 2.5V, Dual I/O LD: 1.8V, Dual I/O R: 3V, RPMC LT: 1.8V, Octal I/O WD: 1.65~3.6V, Dual I/O S: 3V, Stack Die, Quad I/O, QE=1</p> <p>Density</p> <table border="0"> <tr><td>512/05: 512Kb</td><td>64: 64Mb</td></tr> <tr><td>10: 1Mb</td><td>127: 128Mb</td></tr> <tr><td>20/21: 2Mb</td><td>128: 128Mb</td></tr> <tr><td>40/41: 4Mb</td><td>256: 256Mb</td></tr> <tr><td>80: 8Mb</td><td>257: 256Mb</td></tr> <tr><td>16: 16Mb</td><td>512M: 512Mb</td></tr> <tr><td>32: 32Mb</td><td>1G: 1Gb</td></tr> </table>	512/05: 512Kb	64: 64Mb	10: 1Mb	127: 128Mb	20/21: 2Mb	128: 128Mb	40/41: 4Mb	256: 256Mb	80: 8Mb	257: 256Mb	16: 16Mb	512M: 512Mb	32: 32Mb	1G: 1Gb	<p>GD 25 Q 64 C S I G Y</p> <p>Packing Type T or No mark : Tube ; R : Tape&Reel ; Y : Tray</p> <p>Special Options G: Pb Free + Halogen Free Green Package P: Pb Free Only Green ; N: Normal Pb Package S: Pb Free + Halogen Free Green Package + SRP1 function Q: Pb Free + Halogen Free Green Package + 4 Byte Address Mode D: Pb Free + Halogen Free Green Package + DTR function R: Pb Free + Halogen Free Green Package + RESET# function</p> <p>Temperature Range</p> <table border="0"> <tr><td>M: Mobile (-40 C ~ +85 C)</td><td>E: Industrial (-40 C ~ +125 C)</td></tr> <tr><td>C: Commercial (0 C ~ +70 C)</td><td>F: Industrial+ (-40 C ~ +85 C)</td></tr> <tr><td>I: Industrial (-40 C ~ +85 C)</td><td>A: Automotive (-40 C ~ +125 C)</td></tr> <tr><td>J: Industrial (-40 C ~ +105 C)</td><td>2: Automotive (-40 C ~ +105 C)</td></tr> <tr><td></td><td>3: Automotive (-40 C ~ +85 C)</td></tr> </table> <p>Package Type</p> <table border="0"> <tr><td>D: RDL wafer</td><td>U: USON8 3*2mm (0.55mm thickness)</td></tr> <tr><td>P: DIP8 300mil</td><td>E: USON8 3*2mm (0.45mm thickness)</td></tr> <tr><td>F: SOP16 300mil</td><td>H: USON8 3*3mm</td></tr> <tr><td>S: SOP8 208mil</td><td>N: USON8 3*4mm</td></tr> <tr><td>T: SOP8 150mil</td><td>A: USON8 4*3mm</td></tr> <tr><td>V: VSOP8 208mil</td><td>G: Normal wafer</td></tr> <tr><td>M: VSOP8 150mil</td><td>J: USON8 4*4mm (0.55mm thickness)</td></tr> <tr><td>O: TSSOP8 173mil</td><td>Q: USON8 4*4mm (0.45mm thickness)</td></tr> <tr><td>L: WLCSOP</td><td>W: WSON8 6*5mm</td></tr> <tr><td>I: LGA8 4*4mm</td><td>Y: WSON8 8*6mm</td></tr> <tr><td>9: LGA8 6*8mm</td><td>Z: TFBGA-24ball 6*8mm (6*4 ball array)</td></tr> <tr><td>8: LGA8 3*2mm</td><td>B: TFBGA-24ball 6*8mm (5*5 ball array)</td></tr> </table>	M: Mobile (-40 C ~ +85 C)	E: Industrial (-40 C ~ +125 C)	C: Commercial (0 C ~ +70 C)	F: Industrial+ (-40 C ~ +85 C)	I: Industrial (-40 C ~ +85 C)	A: Automotive (-40 C ~ +125 C)	J: Industrial (-40 C ~ +105 C)	2: Automotive (-40 C ~ +105 C)		3: Automotive (-40 C ~ +85 C)	D: RDL wafer	U: USON8 3*2mm (0.55mm thickness)	P: DIP8 300mil	E: USON8 3*2mm (0.45mm thickness)	F: SOP16 300mil	H: USON8 3*3mm	S: SOP8 208mil	N: USON8 3*4mm	T: SOP8 150mil	A: USON8 4*3mm	V: VSOP8 208mil	G: Normal wafer	M: VSOP8 150mil	J: USON8 4*4mm (0.55mm thickness)	O: TSSOP8 173mil	Q: USON8 4*4mm (0.45mm thickness)	L: WLCSOP	W: WSON8 6*5mm	I: LGA8 4*4mm	Y: WSON8 8*6mm	9: LGA8 6*8mm	Z: TFBGA-24ball 6*8mm (6*4 ball array)	8: LGA8 3*2mm	B: TFBGA-24ball 6*8mm (5*5 ball array)
512/05: 512Kb	64: 64Mb																																																
10: 1Mb	127: 128Mb																																																
20/21: 2Mb	128: 128Mb																																																
40/41: 4Mb	256: 256Mb																																																
80: 8Mb	257: 256Mb																																																
16: 16Mb	512M: 512Mb																																																
32: 32Mb	1G: 1Gb																																																
M: Mobile (-40 C ~ +85 C)	E: Industrial (-40 C ~ +125 C)																																																
C: Commercial (0 C ~ +70 C)	F: Industrial+ (-40 C ~ +85 C)																																																
I: Industrial (-40 C ~ +85 C)	A: Automotive (-40 C ~ +125 C)																																																
J: Industrial (-40 C ~ +105 C)	2: Automotive (-40 C ~ +105 C)																																																
	3: Automotive (-40 C ~ +85 C)																																																
D: RDL wafer	U: USON8 3*2mm (0.55mm thickness)																																																
P: DIP8 300mil	E: USON8 3*2mm (0.45mm thickness)																																																
F: SOP16 300mil	H: USON8 3*3mm																																																
S: SOP8 208mil	N: USON8 3*4mm																																																
T: SOP8 150mil	A: USON8 4*3mm																																																
V: VSOP8 208mil	G: Normal wafer																																																
M: VSOP8 150mil	J: USON8 4*4mm (0.55mm thickness)																																																
O: TSSOP8 173mil	Q: USON8 4*4mm (0.45mm thickness)																																																
L: WLCSOP	W: WSON8 6*5mm																																																
I: LGA8 4*4mm	Y: WSON8 8*6mm																																																
9: LGA8 6*8mm	Z: TFBGA-24ball 6*8mm (6*4 ball array)																																																
8: LGA8 3*2mm	B: TFBGA-24ball 6*8mm (5*5 ball array)																																																
<p>Version A or No mark: A Version B: B Version C: C Version D: D Version E: E Version F: F Version</p>																																																	



GD SPI NOR Flash Feature list

Flash Type	3.0V												2.5V			1.65V~3.6V	1.8V									
Family	GD25Q				GD25B		GD25R			GD25D		GD25VQ	GD25VE	GD25VD	GD25WD	GD25LQ		GD25LB		GD25LH		GD25LE	GD25LD			
Part No.	xx	x1B	xxB	xxC	xxB	xxC	xxB	xxC	xxD	xxB	xxC	x1B	xxC	xxC	xxB	xxC	xx/xxB	xxC	xxD	xx	xxC	xxD	xx/xxB	xxC	xxC/xxD	xxC
Single I/O (1-1-1)	•	•	•	•	•	•	•	•	•	•	•	•	•	•	•	•	•	•	•	•	•	•	•	•	•	•
Dual Output (1-1-2)	•	•	•	•	•	•	•	•	•	•	•	•	•	•	•	•	•	•	•	•	•	•	•	•	•	•
Dual I/O (1-2-2)	•	•	•	•	•	•	•	•	•	•	•	•	•	•	•	•	•	•	•	•	•	•	•	•	•	•
Quad Output (1-1-4)	•	•	•	•	•	•	•	•	•	•	•	•	•	•	•	•	•	•	•	•	•	•	•	•	•	•
Quad I/O (1-4-4)	•	•	•	•	•	•	•	•	•	•	•	•	•	•	•	•	•	•	•	•	•	•	•	•	•	•
QPI (4-4-4)																	•	•	•	•	•	•	•	•	•	•
HOLD# Pin	•	•	•	•								•	•	•			•	•	•				•	•	•	•
H/W Reset (RESET Pin)				•*								•*	•*													
S/W Reset				•	•		•	•				•	•				•	•	•	•	•	•	•	•	•	•
H/W Write Protection (WP# Pin)	•	•	•	•						•	•	•	•	•	•	•	•	•	•	•	•	•	•	•	•	•
S/W Write Protection	•	•	•	•	•	•	•	•	•	•	•	•	•	•	•	•	•	•	•	•	•	•	•	•	•	•
Enhanced Block Protection		•	•	•	•	•	•	•	•			•	•				•	•	•	•	•	•	•	•	•	•
Volatile & Non-volatile Status Register Bits		•	•	•			•	•	•			•	•				•	•	•	•	•	•	•	•	•	•
Output Driver Strength				•	•		•	•				•	•													
Security Registers with OTP locks		•	•	•	•		•	•				•	•				•	•	•	•	•	•	•	•	•	•
SFDP Register				•	•	•	•	•				•	•				•	•	•	•	•	•	•	•	•	•

* Only available in Q64, Q127, Q256, Q512M device.

GD SPI NOR Flash Product list

Part No.	Density	Voltage	Organization	I/O Bus	Frequency (MHz)
GD25Q512MC	512Mb	2.7V-3.6V	4KB / 32KB / 64KB	Single / Dual / Quad	104MHz(x1, x2, x4)
GD25Q256C*	256Mb	2.7V-3.6V	4KB / 32KB / 64KB	Single / Dual / Quad	104MHz(x1, x2, x4)
GD25Q256D	256Mb	2.7V-3.6V	4KB / 32KB / 64KB	Single / Dual / Quad	104MHz(x1, x2, x4)
GD25B256D	256Mb	2.7V-3.6V	4KB / 32KB / 64KB	Single / Dual / Quad	104MHz(x1, x2, x4)
GD25R256D	256Mb	2.7V-3.6V	4KB / 32KB / 64KB	Single / Dual / Quad	104MHz(x1, x2, x4)
GD25B256C*	256Mb	2.7V-3.6V	4KB / 32KB / 64KB	Single / Dual / Quad	104MHz(x1, x2, x4)
GD25Q127C	128Mb	2.7V-3.6V	4KB / 32KB / 64KB	Single / Dual / Quad	104MHz(x1, x2, x4)
GD25B127D	128Mb	2.7V-3.6V	4KB / 32KB / 64KB	Single / Dual / Quad	104MHz(x1, x2, x4)
GD25R127D	128Mb	2.7V-3.6V	4KB / 32KB / 64KB	Single / Dual / Quad	104MHz(x1, x2, x4)
GD25Q64C	64Mb	2.7V-3.6V	4KB / 32KB / 64KB	Single / Dual / Quad	120MHz(x1, x2, x4)
GD25B64C	64Mb	2.7V-3.6V	4KB / 32KB / 64KB	Single / Dual / Quad	120MHz(x1, x2, x4)
GD25R64C	64Mb	2.7V-3.6V	4KB / 32KB / 64KB	Single / Dual / Quad	120MHz(x1, x2, x4)
GD25Q32C	32Mb	2.7V-3.6V	4KB / 32KB / 64KB	Single / Dual / Quad	120MHz(x1, x2, x4)
GD25B32C	32Mb	2.7V-3.6V	4KB / 32KB / 64KB	Single / Dual / Quad	120MHz(x1, x2, x4)
GD25Q16C	16Mb	2.7V-3.6V	4KB / 32KB / 64KB	Single / Dual / Quad	120MHz(x1, x2, x4)
GD25B16C	16Mb	2.7V-3.6V	4KB / 32KB / 64KB	Single / Dual / Quad	120MHz(x1, x2, x4)
GD25Q80C	8Mb	2.7V-3.6V	4KB / 32KB / 64KB	Single / Dual / Quad	120MHz(x1, x2, x4)
GD25Q40C	4Mb	2.7V-3.6V	4KB / 32KB / 64KB	Single / Dual / Quad	120MHz(x1, x2, x4)
GD25D40C	4Mb	2.7V-3.6V	4KB / 32KB / 64KB	Single / Dual Output	100MHz(x1) 80MHz(x2)
GD25Q20C	2Mb	2.7V-3.6V	4KB / 32KB / 64KB	Single / Dual / Quad	120MHz(x1, x2, x4)
GD25D20C	2Mb	2.7V-3.6V	4KB / 32KB / 64KB	Single / Dual Output	100MHz(x1) 80MHz(x2)
GD25D10B	1Mb	2.7V-3.6V	4KB / 32KB / 64KB	Single / Dual Output	80MHz(x1, x2)
GD25WD40C	4Mb	1.65V~3.6V	4KB / 32KB / 64KB	Single / Dual Output	100MHz(x1) 80MHz(x2)
GD25WD20C	2Mb	1.65V~3.6V	4KB / 32KB / 64KB	Single / Dual Output	100MHz(x1) 80MHz(x2)
GD25VD10B	1Mb	2.3V-3.6V	4KB / 32KB / 64KB	Single / Dual Output	80MHz(x1, x2)
GD25D05B	512Kb	2.7V-3.6V	4KB / 32KB / 64KB	Single / Dual Output	80MHz(x1, x2)
GD25VD05B	512Kb	2.3V-3.6V	4KB / 32KB / 64KB	Single / Dual Output	80MHz(x1, x2)
GD25VQ64C	64Mb	2.3V-3.6V	4KB / 32KB / 64Kb	Single / Dual / Quad	104MHz(x1, x2, x4)
GD25VQ32C	32Mb	2.3V-3.6V	4KB / 32KB / 64KB	Single / Dual / Quad	104MHz(x1, x2, x4)
GD25VQ16C	16Mb	2.3V-3.6V	4KB / 32KB / 64KB	Single / Dual / Quad	104MHz(x1, x2, x4)
GD25VQ80C	8Mb	2.3V-3.6V	4KB / 32KB / 64KB	Single / Dual / Quad	104MHz(x1, x2, x4)
GD25VQ40C	4Mb	2.3V-3.6V	4KB / 32KB / 64KB	Single / Dual / Quad	104MHz(x1, x2, x4)
GD25VQ20C	2Mb	2.3V-3.6V	4KB / 32KB / 64KB	Single / Dual / Quad	104MHz(x1, x2, x4)
GD25VE64C	64Mb	2.1V-3.6V	4KB / 32KB / 64Kb	Single / Dual / Quad	104MHz(x1, x2, x4)
GD25VE32C	32Mb	2.1V-3.6V	4KB / 32KB / 64KB	Single / Dual / Quad	104MHz(x1, x2, x4)
GD25VE16C	16Mb	2.1V-3.6V	4KB / 32KB / 64KB	Single / Dual / Quad	104MHz(x1, x2, x4)
GD25VE40C	4Mb	2.1V-3.6V	4KB / 32KB / 64KB	Single / Dual / Quad	104MHz(x1, x2, x4)
GD25VE20C	2Mb	2.1V-3.6V	4KB / 32KB / 64KB	Single / Dual / Quad	104MHz(x1, x2, x4)
GD25LQ256D	256Mb	1.65V-2.0V	4KB / 32KB / 64KB	Single / Dual / Quad	120MHz(x1, x2, x4)
GD25LE256D	256Mb	1.65V-2.0V	4KB / 32KB / 64KB	Single / Dual / Quad	120MHz(x1, x2, x4)
GD25LQ128D	128Mb	1.65V-2.0V	4KB / 32KB / 64KB	Single / Dual / Quad	120MHz(x1, x2, x4)
GD25LE128D	128Mb	1.65V-2.0V	4KB / 32KB / 64KB	Single / Dual / Quad	120MHz(x1, x2, x4)
GD25LB128D	128Mb	1.65V-2.0V	4KB / 32KB / 64KB	Single / Dual / Quad	120MHz(x1, x2, x4)
GD25LQ64C	64Mb	1.65V-2.0V	4KB / 32KB / 64KB	Single / Dual / Quad	133MHz(x1, x2, x4)
GD25LE64C	64Mb	1.65V-2.0V	4KB / 32KB / 64KB	Single / Dual / Quad	120MHz(x1, x2, x4)
GD25LB64C	64Mb	1.65V-2.0V	4KB / 32KB / 64KB	Single / Dual / Quad	133MHz(x1, x2, x4)
GD25LQ32D	32Mb	1.65V-2.0V	4KB / 32KB / 64KB	Single / Dual / Quad	120MHz(x1, x2, x4)
GD25LE32D	32Mb	1.65V-2.0V	4KB / 32KB / 64KB	Single / Dual / Quad	120MHz(x1, x2, x4)
GD25LB32D	32Mb	1.65V-2.0V	4KB / 32KB / 64KB	Single / Dual / Quad	120MHz(x1, x2, x4)
GD25LQ16*	16Mb	1.65V-2.0V	4KB / 32KB / 64KB	Single / Dual / Quad	120MHz(x1, x2, x4)
GD25LQ16C	16Mb	1.65V-2.1V	4KB / 32KB / 64KB	Single / Dual / Quad	104MHz(x1, x2, x4)
GD25LE16C	16Mb	1.65V-2.1V	4KB / 32KB / 64KB	Single / Dual / Quad	104MHz(x1, x2, x4)
GD25LB16*	16Mb	1.65V-2.0V	4KB / 32KB / 64KB	Single / Dual / Quad	120MHz(x1, x2, x4)
GD25LB16C	16Mb	1.65V-2.1V	4KB / 32KB / 64KB	Single / Dual / Quad	104MHz(x1, x2, x4)
GD25LH16*	16Mb	1.65V-1.95V	4KB / 32KB / 64KB	Single / Dual / Quad	120MHz(x1, x2, x4)
GD25LH16C	16Mb	1.65V-2.1V	4KB / 32KB / 64KB	Single / Dual / Quad	104MHz(x1, x2, x4)
GD25LQ80B	8Mb	1.65V-2.1V	4KB / 32KB / 64KB	Single / Dual / Quad	104MHz(x1, x2, x4)
GD25LH80B	8Mb	1.65V-1.95V	4KB / 32KB / 64KB	Single / Dual / Quad	104MHz(x1, x2, x4)
GD25LQ40B	4Mb	1.65V-2.1V	4KB / 32KB / 64KB	Single / Dual / Quad	104MHz(x1, x2, x4)
GD25LD40C	4Mb	1.65V-2.0V	4KB / 32KB / 64KB	Single / Dual Output	40MHz(x1, x2)
GD25LQ20B	2Mb	1.65V-2.1V	4KB / 32KB / 64KB	Single / Dual / Quad	104MHz(x1, x2, x4)
GD25LD20C	2Mb	1.65V-2.0V	4KB / 32KB / 64KB	Single / Dual Output	40MHz(x1, x2)
GD25LQ10B	1Mb	1.65V-2.1V	4KB / 32KB / 64KB	Single / Dual / Quad	104MHz(x1, x2, x4)
GD25LQ05B	512Kb	1.65V-2.1V	4KB / 32KB / 64KB	Single / Dual / Quad	104MHz(x1, x2, x4)

* Not recommended for new design.

Product Series

3V

Q: Quad I/O, General
B: Quad I/O, QE=1
D: Dual Output
R: Quad I/O, QE=1, For RPMC

2.5V

VQ: Quad I/O, General
VD: Dual Output
VE: Quad I/O, For DPD

1.8V

LQ: Quad I/O, General
LB: Quad I/O, QE=1
LH: Quad I/O, For HDD
LD: Dual Output
LE: Quad I/O, For DPD

SPI NAND Flash

GD SPI NAND Flash Features

3.0V

- ◆ **Power Supply Voltage:** 2.7V~3.6V
- ◆ **High Speed Clock Frequency**
 - 120MHz for fast read with 30PF load
 - Quad I/O Data transfer up to 480Mbits/s
- ◆ **Flexible Memory Architecture**
 - 1Gbit & 2Gbit:**
 - 2048-Byte page for read and program, spare area 128-Byte
 - (128K + 8K)-Byte per block for erase
 - 4Gbit & 8Gbit:**
 - 4096-Byte page for read and program, spare area 256-Byte
 - (256K + 16K)-Byte per block for erase
- ◆ **Enhanced Access Performance**
 - 2K-Byte cache for fast random read for 1G & 2G
 - 4K-Byte cache for fast random read for 4G & 8G
 - Cache read and cache program
- ◆ **Advanced Feature for NAND**
 - Internal ECC option
 - Internal data move by page with ECC
 - Promised good block0 with ECC

1.8V

- ◆ **Power Supply Voltage:** 1.7V~2.0V
- ◆ **High Speed Clock Frequency**
 - 120MHz for fast read with 30PF load
 - Quad I/O Data transfer up to 480Mbits/s
- ◆ **Flexible Memory Architecture**
 - 1Gbit & 2Gbit:**
 - 2048-Byte page for read and program, spare area 128-Byte
 - (128K + 8K)-Byte per block for erase
 - 4Gbit & 8Gbit:**
 - 4096-Byte page for read and program, spare area 256-Byte
 - (256K + 16K)-Byte per block for erase
- ◆ **Enhanced Access Performance**
 - 2K-Byte cache for fast random read for 1G & 2G
 - 4K-Byte cache for fast random read for 4G & 8G
 - Cache read and cache program
- ◆ **Advanced Feature for NAND**
 - Internal ECC option
 - Internal data move by page with ECC
 - Promised good block0 with ECC

GD SPI NAND Flash Product List

Part No.	Density	Package
GD5F8GQ4U	8Gb	LGA8 8*6mm
GD5F4GQ4U	4Gb	WSON8/LGA8 8*6mm
GD5F2GQ4U	2Gb	WSON8/LGA8 8*6mm
GD5F1GQ4U	1Gb	WSON8 8*6mm

Part No.	Density	Package
GD5F8GQ4R	8Gb	LGA8 8*6mm
GD5F4GQ4R	4Gb	WSON8/LGA8 8*6mm
GD5F2GQ4R	2Gb	WSON8/LGA8 8*6mm
GD5F1GQ4R	1Gb	WSON8/LGA8 8*6mm

GD SPI NAND Flash Example

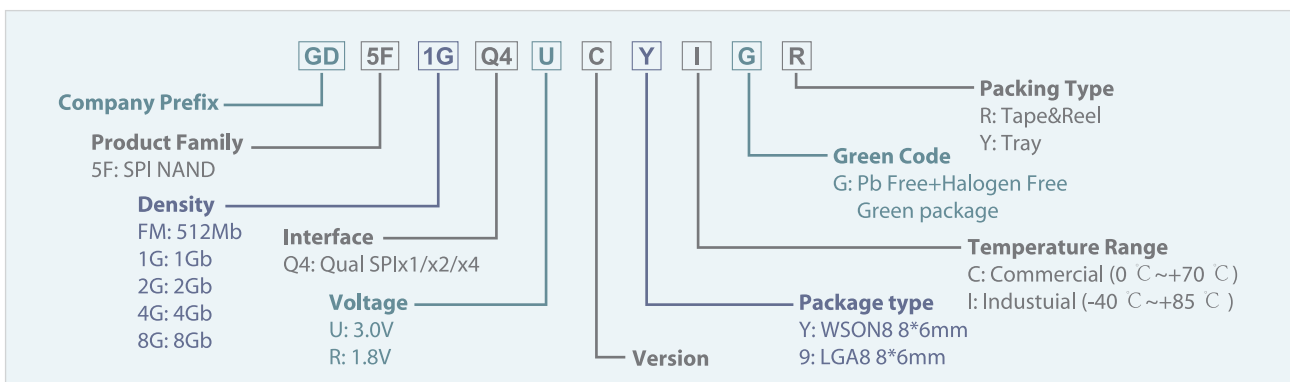

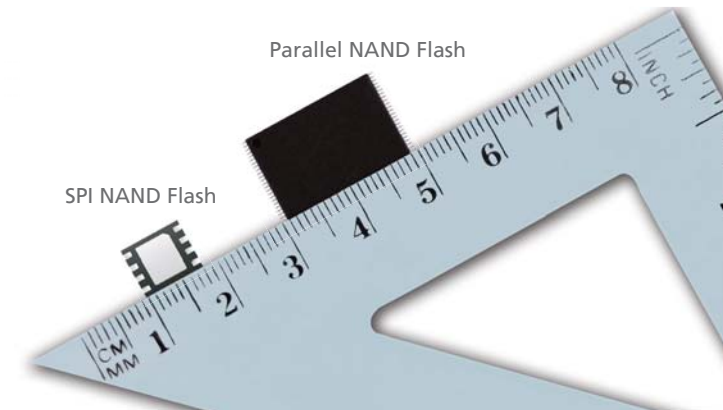

Advantages – Small Size

Reduce Package cost

Advantages – Less Pin



Reduce Core Chip Cost

Fewer pins required by SPI NAND reduces the Core Chip pin count.

Advantages – PCB cost

Reduced pin count Core Chip and small SPI NAND Flash chip result in smaller PCB area and cost reduction.

Reduce PCB Cost ▲

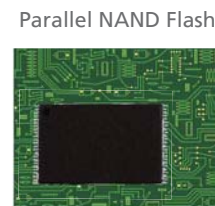
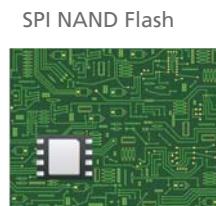

Advantages – Design

Reduce PCB difficulty
Cut down design cycles ▼

Less pins than Parallel NAND Flash, help make it easier for layout, reduce PCB design difficulty, Cut down design cycles of electronic products.

Design based on SPI NAND Flash



Design based on Parallel NAND Flash



Flash Package Options

Unit: mm

T		SOP8 150mil	
		Length(Normal)	4.90
		Width(Normal)	6.00
		Pitch(Normal)	1.27
S		SOP8 208mil	
		Length(Normal)	5.23
		Width(Normal)	7.90
		Pitch(Normal)	1.27
M		VSOP8 150mil	
		Length(Normal)	4.90
		Width(Normal)	6.00
		Pitch(Normal)	1.27
V		VSOP8 208mil	
		Length(Normal)	5.28
		Width(Normal)	7.90
		Pitch(Normal)	1.27
O		TSSOP8 173mil	
		Length(Normal)	2.96
		Width(Normal)	6.40
		Pitch(Normal)	0.65
F		SOP16 300mil	
		Length(Normal)	10.30
		Width(Normal)	10.35
		Pitch(Normal)	1.27
C		TSOP56 14*20	
		Length(Normal)	14.00
		Width(Normal)	20.00
		Pitch(Normal)	0.50
P		DIP8 300mil	
		Length(Normal)	9.32
		Width(Normal)	7.94
		Pitch(Normal)	2.54
Z		TFBGA-24ball 6*8 (6*4ball array)	
		Length(Normal)	6.00
		Width(Normal)	8.00
		Pitch(Normal)	1.00
B		TFBGA-24ball 6*8 (5*5ball array)	
		Length(Normal)	6.00
		Width(Normal)	8.00
		Pitch(Normal)	1.00
8		LGA8 3*2	
		Length(Normal)	3.00
		Width(Normal)	2.00
		Pitch(Normal)	0.50

U		USON8 3*2 (0.55mm)	
		Length(Normal)	3.00
		Width(Normal)	2.00
		Pitch(Normal)	0.50
E		USON8 3*2 (0.45mm)	
		Length(Normal)	3.00
		Width(Normal)	2.00
		Pitch(Normal)	0.50
H		USON8 3*3	
		Length(Normal)	3.00
		Width(Normal)	3.00
		Pitch(Normal)	0.50
N		USON8 3*4	
		Length(Normal)	3.00
		Width(Normal)	4.00
		Pitch(Normal)	0.80
A		USON8 4*3	
		Length(Normal)	4.00
		Width(Normal)	3.00
		Pitch(Normal)	0.80
J		USON8 4*4 (0.55mm)	
		Length(Normal)	4.00
		Width(Normal)	4.00
		Pitch(Normal)	0.80
Q		USON8 4*4 (0.45mm)	
		Length(Normal)	4.00
		Width(Normal)	4.00
		Pitch(Normal)	0.80
W		WSON8 6*5	
		Length(Normal)	6.00
		Width(Normal)	5.00
		Pitch(Normal)	1.27
Y		WSON8 8*6	
		Length(Normal)	8.00
		Width(Normal)	6.00
		Pitch(Normal)	1.27
L		WLCSF	
		Depends on specific product	

Note:

1. The values provided are the normal values for length, width and pitch, as well as the max values for thickness.
2. The pictures are for reference only, please subject to practicality.

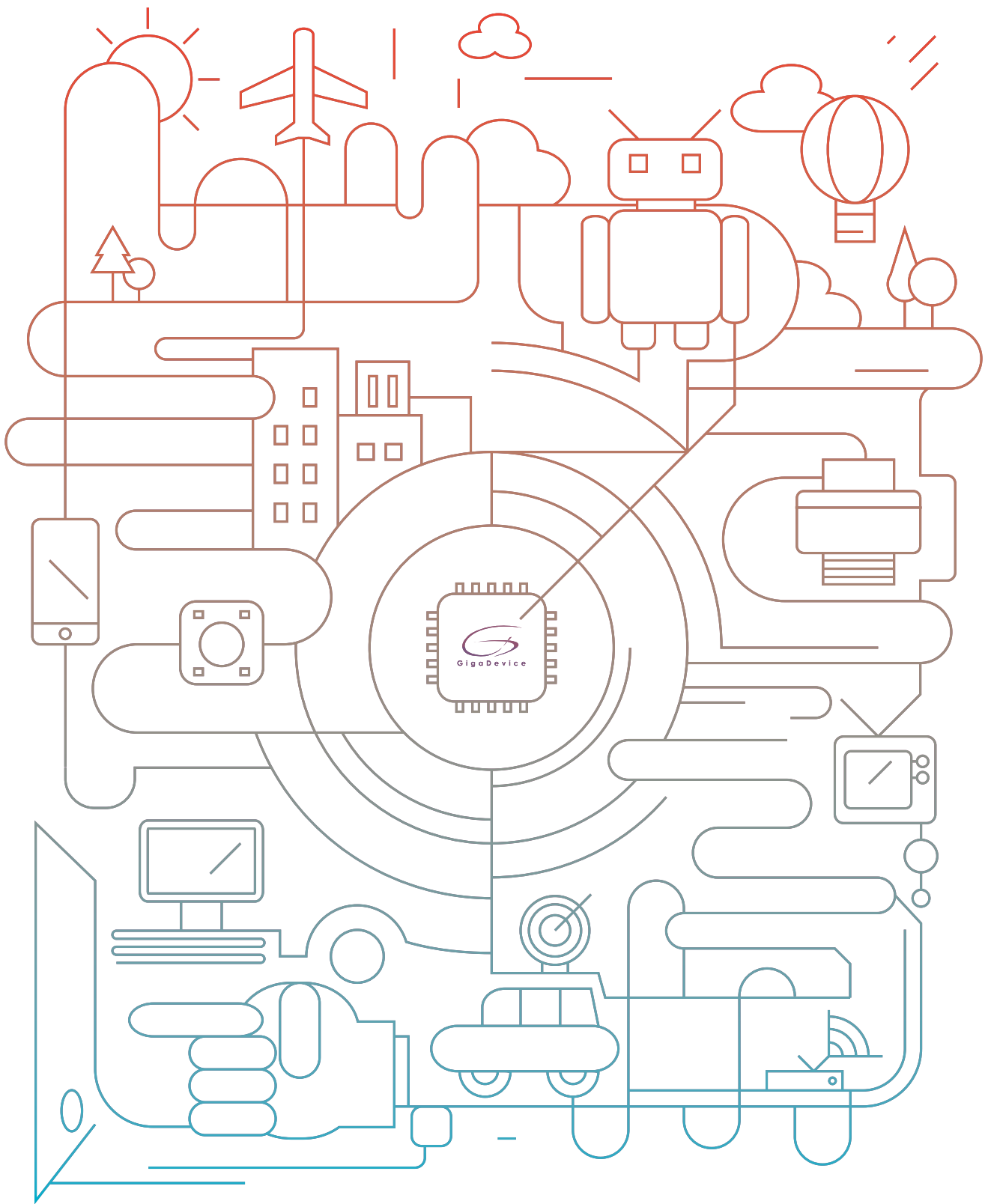

GigaDevice Semiconductor (Beijing) Inc.

Beijing Headquarter

Add: A12, USTB Techart Plaza, Xueyuan Road 30,
Haidian District, Beijing, China
Tel: +86-10-82881666
Fax: +86-10-82881668
E-mail: info@gigadevice.com

Add: A23 Truth Plaza, Zhichun Road 7, Haidian
District, Beijing, China
Tel: +86-10-82263375/76/78/79
Fax: +86-10-82263376-6200
E-mail: info@gigadevice.com

Shanghai Office

Add: Room 603, Tianshan Road 18, Zhaoyi Science
Zone, Shanghai, China
Tel: +86-21-32567770
Fax: +86-21-32567770-803
E-mail: info@gigadevice.com

Add: Room 1515, 5F, Building 1, Guoshoujing Road
498, Zhangjiang High-Tech Park, Pudong New Area,
Shanghai, China
Tel: +86-21-50395591
Fax: +86-21-50395591-803
E-mail: info@gigadevice.com

Shenzhen Office

Add: 2209 Main Building of Tianan Cyber Times,
Chegongmiao, Futian District, Shenzhen, China
Tel: +86-775-83438655
Fax: +86-775-83438655-801
E-mail: info@gigadevice.com

Hefei Office

Add: Fanhua Avenue 266, Economic & Technological
Development Area, Hefei, Anhui, China
Tel: +86-551-68999734
E-mail: info@gigadevice.com

Xi'an Office

Add: B6-04, Ascendas Innovation Hub, Gao Xin 6
Road 38, Hi-tech Industrial Development Zone,
Xi'an, China
Tel: +86-29-88858591
E-mail: info@gigadevice.com

Taiwan Office

Add: 6F.-5, No.171, Songde Rd., Xinyi Dist., Taipei City
110, Taiwan (R.O.C.)
Tel: +886-2-27277210
Fax: +886-2-27277216
E-mail: info@gigadevice.com

USA Office

Add: 2975 Bowers Ave, Suite 323,
Santa Clara, CA 95051 USA
Tel: +1-408-596-3166
E-mail: info@gigadevice.com

Korea Office

Add: Room 108, Business Incubator Center, Korea
Electronics Technology Institute (KETI), Yatap-dong 68,
Bundang-gu, Seongnam, Gyeonggi-do, Korea,
463-816
Tel: +82-31-701-0824
Fax: +82-31-705-0824
E-mail: james@gigadevice.com

Japan Office

Add: DSM Shin-Yokohama building 2F, 2-6-3
Shin-Yokohama, Kohoku, Yokohama 222-0033
Tel: +81-45-534-4102
Fax: +81-45-534-4103
E-mail: info@gigadevice.com

UK Office

GigaDevice Semiconductor Europe Ltd
Add: Innovation House
Molly Millars Close
Wokingham
Berkshire
RG41 2RX
United Kingdom
Tel: +44 (0) 7585 707735

