

# HER201 THRU HER208

## List

List..... 1

Package outline..... 2

Features..... 2

Mechanical data..... 2

Maximum ratings .....2

Rating and characteristic curves..... 3

Pinning information.....4

Marking..... 4

Taping & bulk specifications for AXIAL devices..... 4

Suggested thermal profiles for soldering processes..... 5

High reliability test capabilities.....6

# HER201 THRU HER208

## 2.0A Axial Leaded High Efficiency Rectifiers-50-1000V

### Features

- Axial lead type devices for through hole design.
- High current capability.
- Ultrafast recovery time for high efficiency.
- High surge current capability.
- Silicon rubber coating chip junction.
- Lead-free parts meet RoHS requirements.
- Suffix "-H" indicates Halogen free parts, ex. HER201-H.

### Mechanical data

- Epoxy : UL94-V0 rated flame retardant
- Case : Molded plastic, DO-15
- Lead : Axial leads, solderable per MIL-STD-202, Method 208 guaranteed
- Polarity: Color band denotes cathode end
- Mounting Position : Any
- Weight : Approximated 0.40 gram

### Package outline

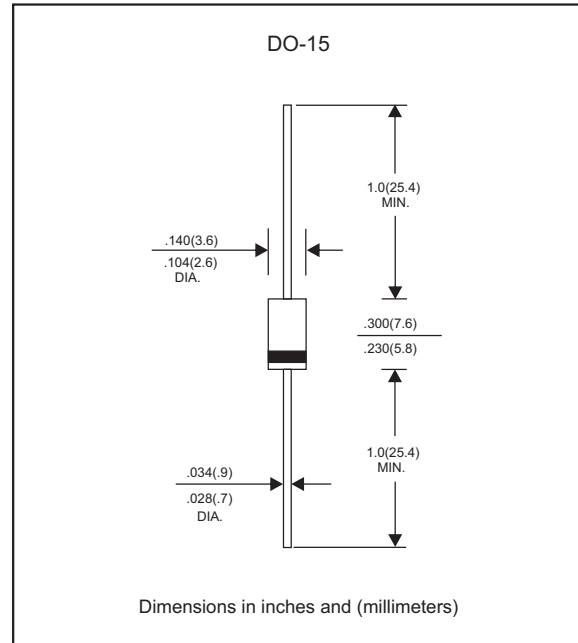

### Maximum ratings and Electrical Characteristics (AT $T_A=25^{\circ}\text{C}$ unless otherwise noted)

PARAMETER	CONDITIONS	Symbol	MIN.	TYP.	MAX.	UNIT
Forward rectified current	Ambient temperature = $50^{\circ}\text{C}$	$I_O$			2.0	A
Forward surge current	8.3ms single half sine-wave (JEDEC method)	$I_{FSM}$			60	A
Reverse current	$V_R = V_{RRM}$ $T_J = 25^{\circ}\text{C}$	$I_R$			5.0	$\mu\text{A}$
	$V_R = V_{RRM}$ $T_J = 100^{\circ}\text{C}$				150	
Diode junction capacitance	f=1MHz and applied 4V DC reverse voltage	$C_J$		30		pF
Storage temperature		$T_{STG}$	-65		+175	$^{\circ}\text{C}$

SYMBOLS	$V_{RRM}^{*1}$ (V)	$V_{RMS}^{*2}$ (V)	$V_R^{*3}$ (V)	$V_F^{*4}$ (V)	$t_{rr}^{*5}$ (ns)	Operating temperature $T_J$ , ( $^{\circ}\text{C}$ )
HER201	50	35	50	1.00	50	
HER202	100	70	100			
HER203	200	140	200			
HER204	300	210	300	1.30		
HER205	400	280	400			
HER206	600	420	600	1.85	75	
HER207	800	560	800			
HER208	1000	700	1000			

- \*1 Repetitive peak reverse voltage
- \*2 RMS voltage
- \*3 Continuous reverse voltage
- \*4 Maximum forward voltage@ $I_F=2.0\text{A}$
- \*5 Maximum Reverse recovery time, note 1

Note 1. Reverse recovery time test condition,  $I_F=0.5\text{A}$ ,  $I_R=1.0\text{A}$ ,  $I_{RR}=0.25\text{A}$

## Rating and characteristic curves (HER201 THRU HER208)

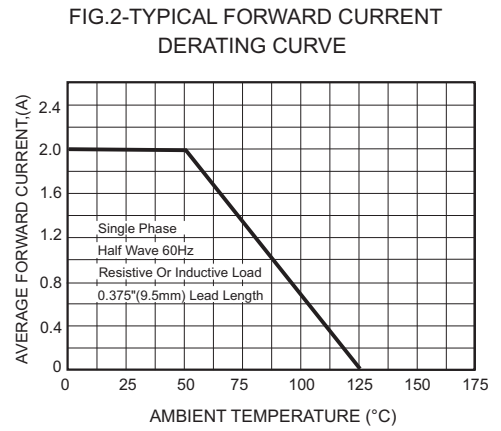
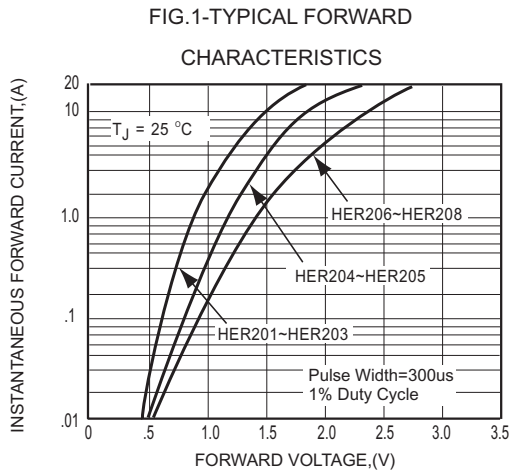

**FIG.3- TEST CIRCUIT DIAGRAM AND REVERSE RECOVERY TIME CHARACTERISTICS**

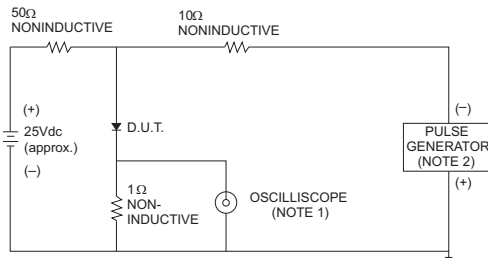

NOTES: 1. Rise Time = 7ns max., Input Impedance = 1 megohm, 22pF.  
 2. Rise Time = 10ns max., Source Impedance = 50 ohms.

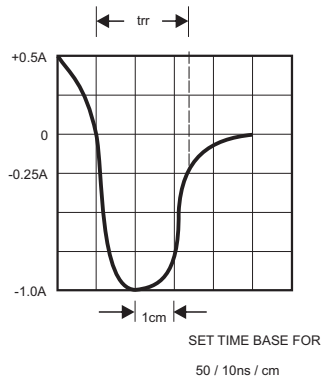

**FIG.4-MAXIMUM NON-REPETITIVE FORWARD SURGE CURRENT**

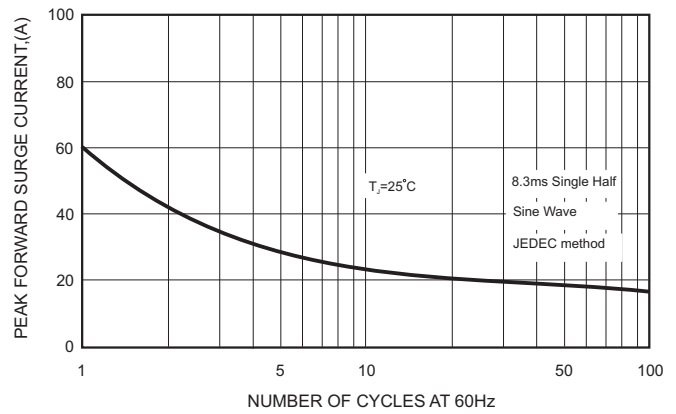

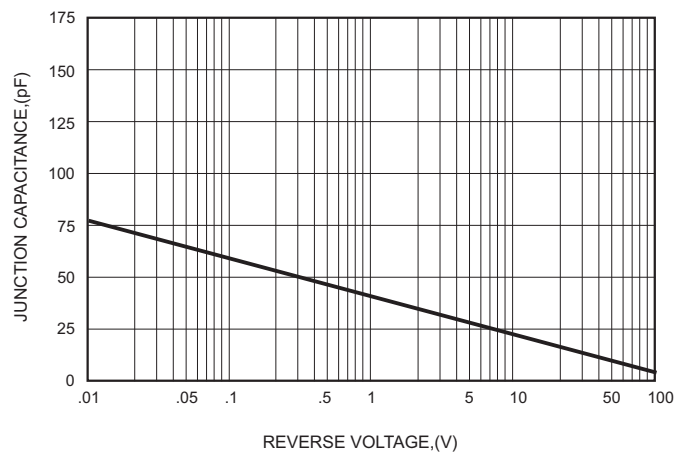

**FIG.5-TYPICAL JUNCTION CAPACITANCE**



# HER201 THRU HER208

## Pinning information

Pin	Simplified outline	Symbol
Pin1 cathode Pin2 anode	1  2	1  2

## Marking

Type number	Marking code
HER201	HER201
HER202	HER202
HER203	HER203
HER204	HER204
HER205	HER205
HER206	HER206
HER207	HER207
HER208	HER208

## Taping & bulk specifications for AXIAL devices

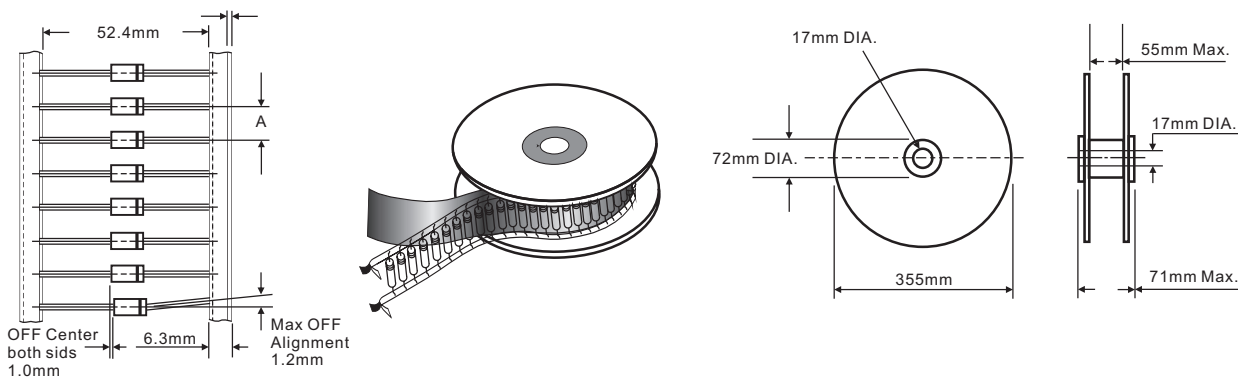

### REEL PACKING

DEVICE CASE TYPE	Q'TY 1 (PCS / REEL)	COMPONENT SPACING "A" in FIG. A	CARTON SIZE (m/m)	Q'TY 2 (PCS / CARTON)	APPROX. CROSS WEIGHT(kg)
DO-15	4,000	5 mm	380 * 340 * 370	16,000	9.9

### AMMO PACKING

DEVICE CASE TYPE	Q'TY 1 (PCS / BOX)	INNER BOX SIZE (m/m)	CARTON SIZE (m/m)	Q'TY 2 (PCS / CARTON)	APPROX. CROSS WEIGHT(kg)
DO-15	3,000	260 * 83 * 160	440 * 270 * 340	30,000	14.3

# HER201 THRU HER208

**BULK PACKING**

DEVICE CASE TYPE	Q'TY 1 (PCS / BOX)	INNER BOX SIZE (m/m)	CARTON SIZE (m/m)	Q'TY 2 (PCS / CARTON)	APPROX. CROSS WEIGHT(kg)
DO-15	500	194 * 84 * 20	465 * 220 * 260	25,000	12.9

**Suggested thermal profiles for soldering processes**

1. Lead free temperature profile wave-soldering

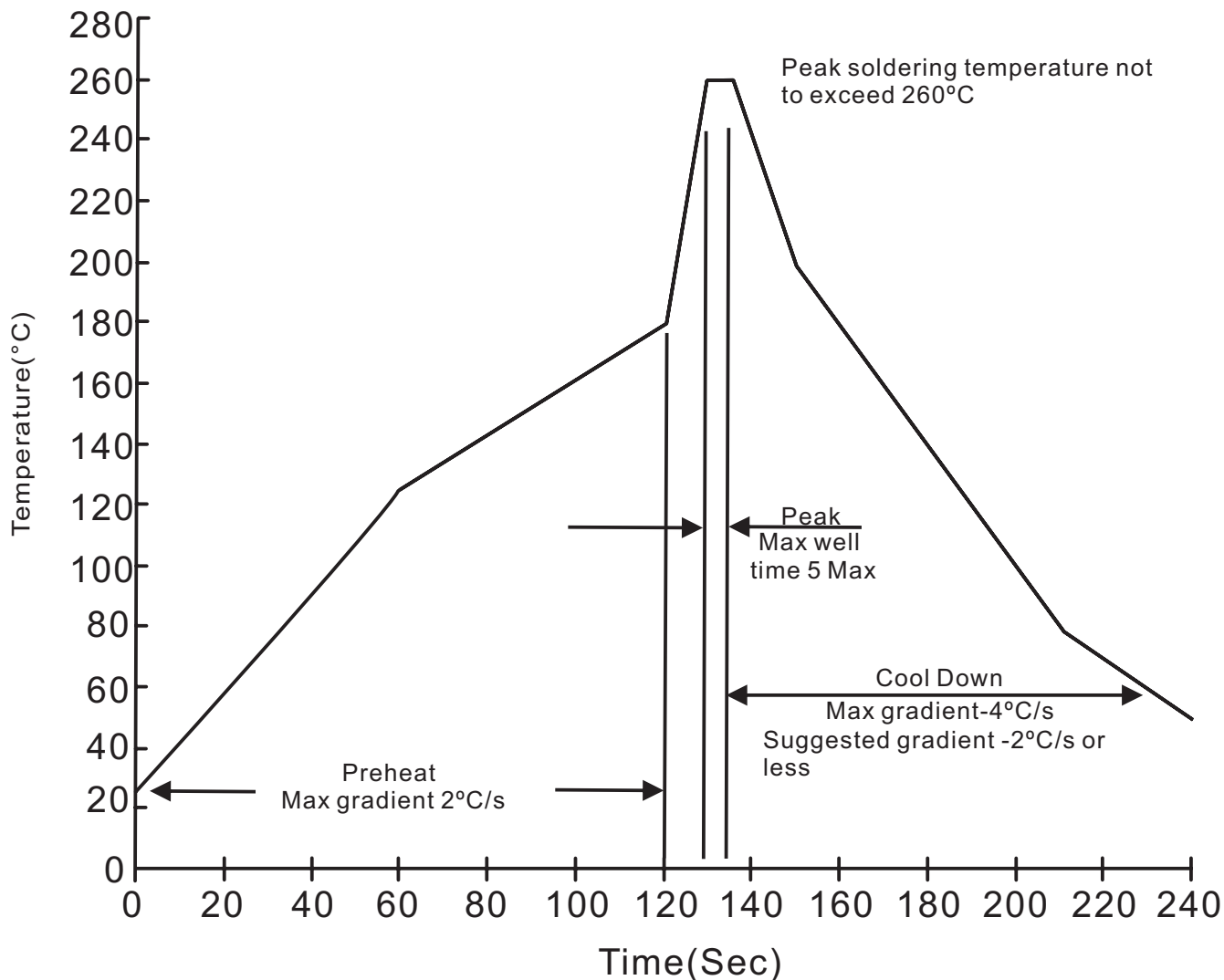

**HER201 THRU HER208****High reliability test capabilities**

Item Test	Conditions	Reference
1. Solder Resistance	at 260±5°C for 10±2sec. immerse body into solder 1/16"±1/32"	MIL-STD-750D METHOD-2031
2. Solderability	at 245±5°C for 5 sec.	MIL-STD-202F METHOD-208
3. Pull Test	1.0kg in axial lead direction for 10 sec. $I_F = I_O$	MIL-STD-202F METHOD-211A
4. Bend Lead	1.0kg weight applied to each lead bending arc 90°±5° for 3 times	MIL-STD-202F METHOD-211A
5. High Temperature Reverse Bias	$V_R = 80\%$ rate at $T_J = 125^\circ\text{C}$ for 168 hrs.	MIL-STD-750D METHOD-1038
6. Forward Operation Life	Rated average rectifier current at $T_A = 25^\circ\text{C}$ for 500hrs. $T_A = 25^\circ\text{C}$ , $I_F = I_O$	MIL-STD-750D METHOD-1027
7. Intermittent Operation Life	On state: power on for 5 min. off state: power off for 5 min, on and off for 500 cycles.	MIL-STD-750D METHOD-1036
8. Pressure Cooker	15P <sub>sig</sub> at $T_A = 121^\circ\text{C}$ for 4 hrs.	JESD22-A102
9. Temperature Cycling	-55°C to +125°C dwelled for 30 min. and transferred for 5min. total 10 cycles.	MIL-STD-750D METHOD-1051
10. Forward Surge	8.3ms single half sine-wave one surge.	MIL-STD-750D METHOD-4066-2
11. Humidity	at $T_A = 85^\circ\text{C}$ , RH=85% for 1000hrs.	MIL-STD-750D METHOD-1021
12. High Temperature Storage Life	at 175°C for 1000 hrs.	MIL-STD-750D METHOD-1031