

**BAT54T / BAT54AT / BAT54CT / BAT54ST**

**List**

List..... 1

Package outline..... 2

Features..... 2

Mechanical data..... 2

Maximum ratings ..... 2

Rating and characteristic curves..... 3

Pinning information..... 4

Marking..... 4

Suggested solder pad layout..... 4

Packing information..... 5

Reel packing..... 6

Suggested thermal profiles for soldering processes..... 6

High reliability test capabilities..... 7

# BAT54T / BAT54AT / BAT54CT / BAT54ST

## 200mA Surface Mount Small Signal Schottky Diodes-30V

### Features

- Low current rectification and high speed switching.
- Tiny surface mount type.
- Up to 200mA current capability.
- Low forward voltage drop
- Silicon epitaxial planar chip, metal silicon junction.
- Lead-free parts for green partner, exceeds environmental standards of MIL-STD-19500 /228
- High speed (  $t_{rr} < 5 \text{ ns}$  )
- Suffix "-H" indicates Halogen free parts, ex. BAT54T-H.

### Mechanical data

- Epoxy:UL94-V0 rated flame retardant
- Case : Molded plastic, SOT-523
- Terminals : Solder plated, solderable per MIL-STD-750, Method 2026
- Mounting Position : Any
- Weight : Approximated 0.003 gram

### Package outline

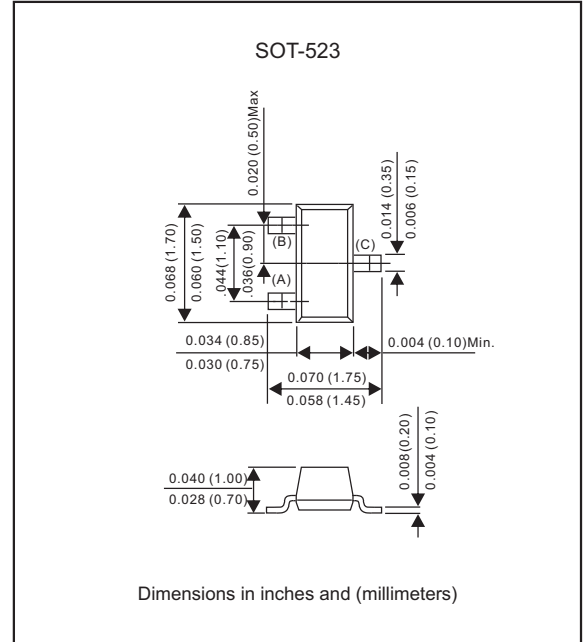

### Maximum ratings and Electrical Characteristics (AT $T_A=25^\circ\text{C}$ unless otherwise noted)

PARAMETER	CONDITIONS	Symbol	MIN.	TYP.	MAX.	UNIT
Repetitive peak reverse voltage		$V_{RRM}$			30	V
Reverse voltage		$V_R$			30	V
RMS Reverse Voltage		$V_{RMS}$			21	V
Non-repetitive Peak Forward Surge Current	at $t < 1.0\text{s}$	$I_{FSM}$			600	mA
Power Dissipation	at $T_A=25^\circ\text{C}$	$P_D$			150	mW
Average Rectified Output Current		$I_O$			200	mA
Thermal resistance	Junction to ambient	$R_{\theta JA}$		833		$^\circ\text{C}/\text{W}$
	Junction to case	$R_{\theta JC}$		630		$^\circ\text{C}/\text{W}$
Operating Junction temperature range		$T_J$	-55		+125	$^\circ\text{C}$
Storage temperature range		$T_{STG}$	-55		+125	$^\circ\text{C}$
Forward voltage	$I_F = 1 \text{ mA}$	$V_F$			0.320	V
	$I_F = 10 \text{ mA}$	$V_F$			0.400	V
	$I_F = 30 \text{ mA}$	$V_F$			0.500	V
	$I_F = 100 \text{ mA}$	$V_F$			1.000	V
Reverse current	$V_R = 25 \text{ V}$	$I_R$			2.0	$\mu\text{A}$
Total Capacitance	$V_R = 1 \text{ V}, f = 1\text{MHz}$	$C_T$			10.0	pF
Reverse recovery time	$I_F = I_R = 10\text{mA}, I_{rr} = 0.1 \times I_R, R_L = 100\Omega$	$t_{rr}$			5	ns

Rating and characteristic curves for each diode (BAT54T / BAT54AT / BAT54CT / BAT54ST)

Forward Characteristics

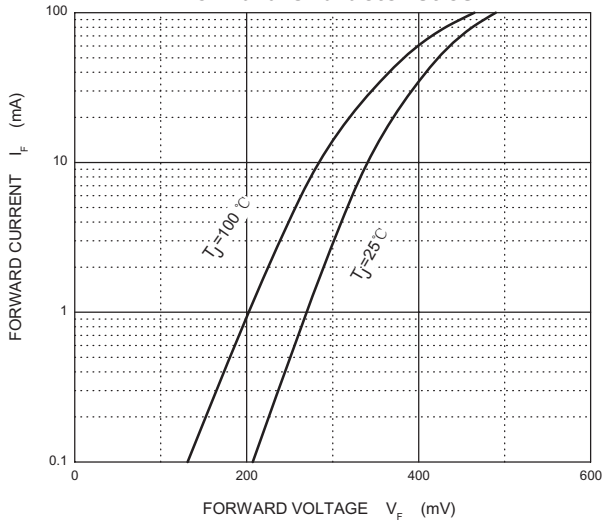

Reverse Characteristics

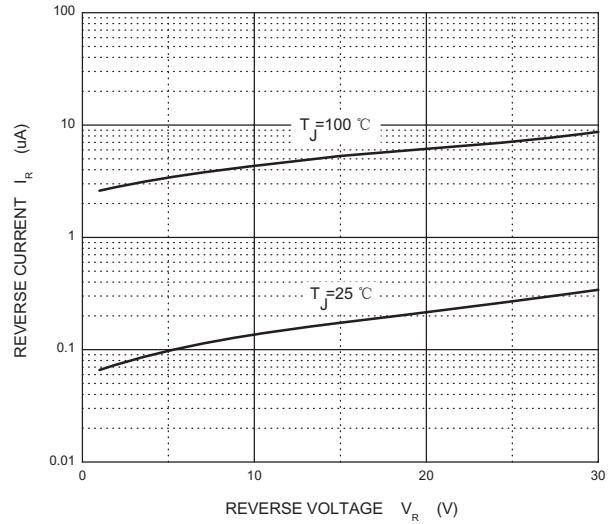

Capacitance Characteristics

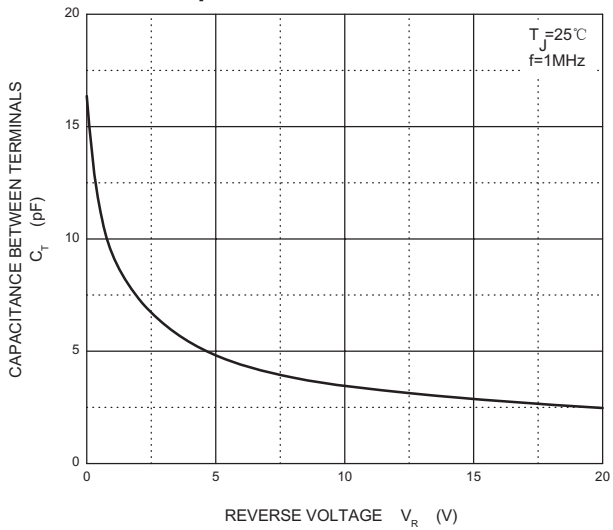

Power Derating Curve

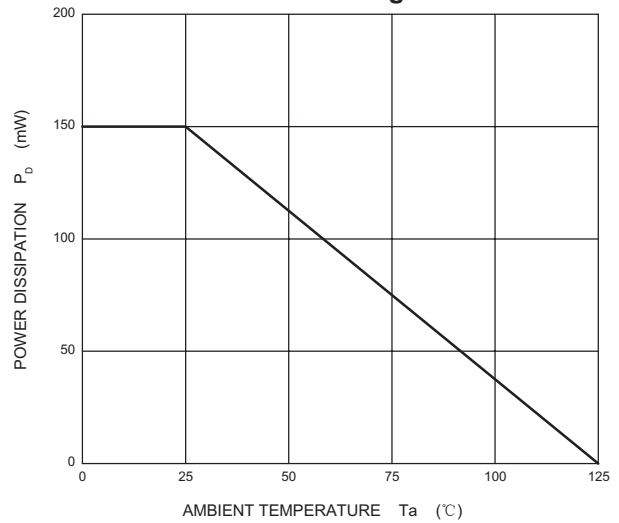

# BAT54T / BAT54AT / BAT54CT / BAT54ST

## Pinning information

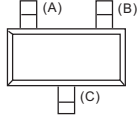
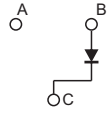
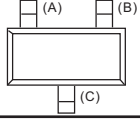
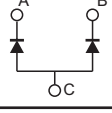
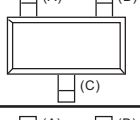
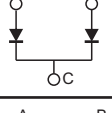
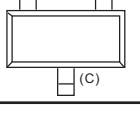
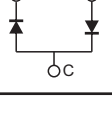
Type number	Marking code	Simplified outline	Symbol
BAT54T	L1		
BAT54AT	L2		
BAT54CT	L3		
BAT54ST	L4		

## Suggested solder pad layout

SOT-523

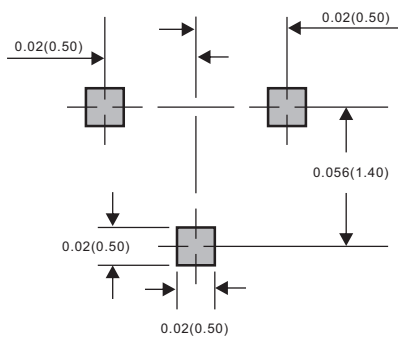

Dimensions in inches and (millimeters)

**BAT54T / BAT54AT / BAT54CT / BAT54ST**

**Packing information**

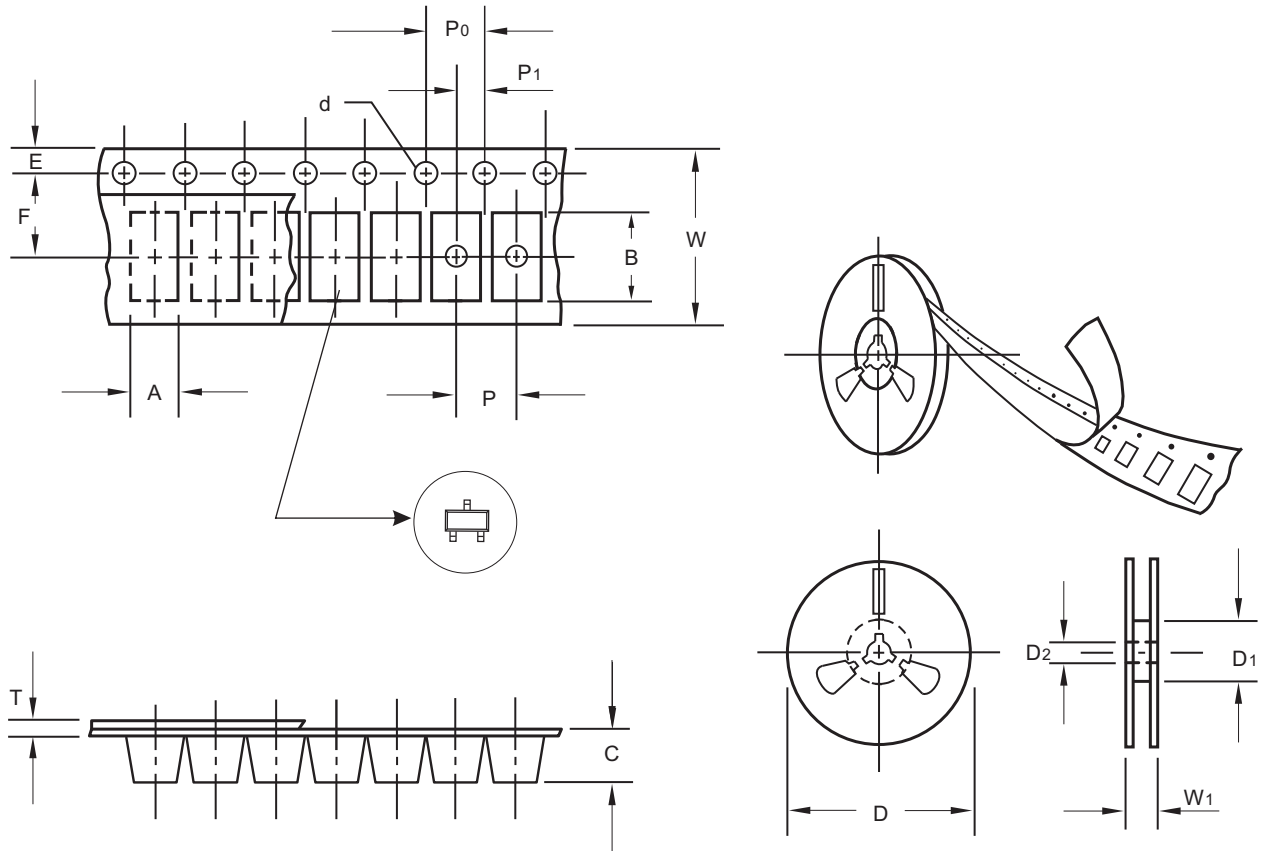

unit:mm

Item	Symbol	Tolerance	SOT-523
Carrier width	A	0.1	1.73
Carrier length	B	0.1	1.85
Carrier depth	C	0.1	0.90
Sprocket hole	d	0.1	1.5
13" Reel outside diameter	D	2.0	-
13" Reel inner diameter	D1	min	-
7" Reel outside diameter	D	2.0	178.00
7" Reel inner diameter	D1	min	60.00
Feed hole diameter	D2	0.5	13.00
Sprocket hole position	E	0.1	1.75
Punch hole position	F	0.1	3.50
Punch hole pitch	P	0.1	4.00
Sprocket hole pitch	P0	0.1	4.00
Embossment center	P1	0.1	2.00
Overall tape thickness	T	0.1	0.23
Tape width	W	0.3	8.00
Reel width	W1	1.0	11.40

Note: Devices are packed in accordance with EIA standard RS-481-A and specifications listed above.

# BAT54T / BAT54AT / BAT54CT / BAT54ST

## Reel packing

PACKAGE	REEL SIZE	REEL (pcs)	COMPONENT SPACING (m/m)	BOX (pcs)	INNER BOX (m/m)	REEL DIA, (m/m)	CARTON SIZE (m/m)	CARTON (pcs)	APPROX. GROSS WEIGHT (kg)
SOT-523	7"	3000	4.0	30,000	183*183*123	178	382*262*387	240,000	9.5

## Suggested thermal profiles for soldering processes

- 1.Storage environment: Temperature=5°C~40°C Humidity=55%±25%
- 2.Reflow soldering of surface-mount devices

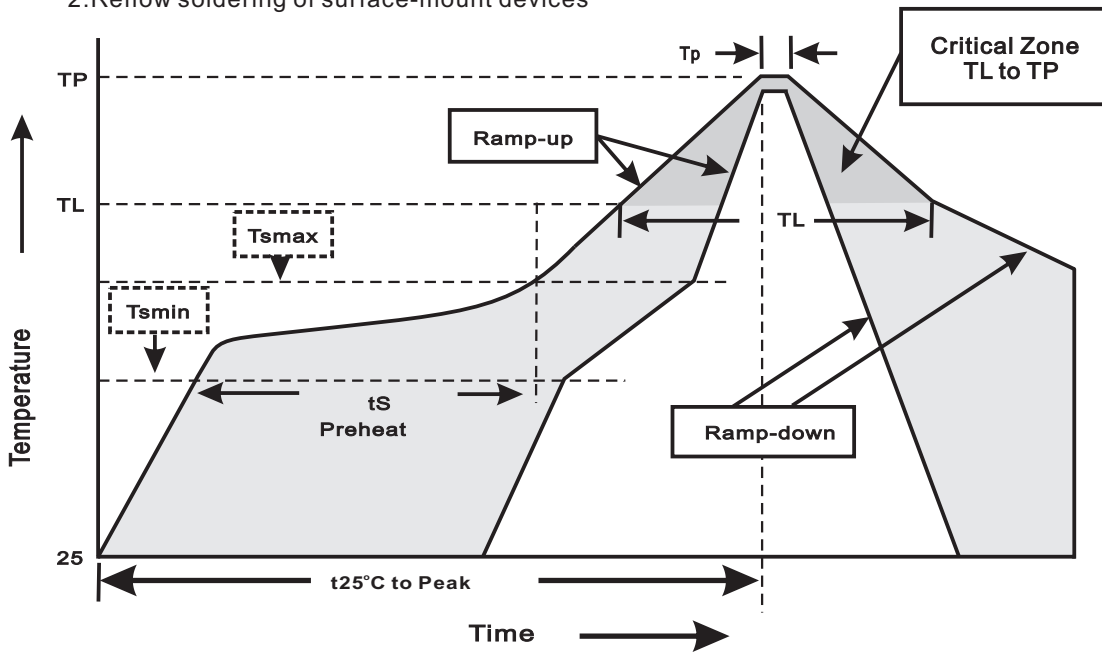

### 3.Reflow soldering

Profile Feature	Soldering Condition
Average ramp-up rate(T <sub>L</sub> to T <sub>P</sub> )	<3°C/sec
Preheat -Temperature Min(T <sub>smmin</sub> ) -Temperature Max(T <sub>smmax</sub> ) -Time(min to max)(t <sub>s</sub> )	150°C 200°C 60~120sec
T <sub>smmax</sub> to T <sub>L</sub> -Ramp-upRate	<3°C/sec
Time maintained above: -Temperature(T <sub>L</sub> ) -Time(t <sub>L</sub> )	217°C 60~260sec
Peak Temperature(T <sub>P</sub> )	255°C-0/+5°C
Time within 5°C of actual Peak Temperature(t <sub>P</sub> )	10~30sec
Ramp-down Rate	<6°C/sec
Time 25°C to Peak Temperature	<6minutes

**BAT54T / BAT54AT / BAT54CT / BAT54ST****High reliability test capabilities**

Item Test	Conditions	Reference
1. Solder Resistance	at 260±5°C for 10±2sec. immerse body into solder 1/16"±1/32"	MIL-STD-750D METHOD-2031
2. Solderability	at 245±5°C for 5 sec.	MIL-STD-202F METHOD-208
3. High Temperature Reverse Bias	$V_R=80\%$ rate at $T_J=125^\circ\text{C}$ for 168 hrs.	MIL-STD-750D METHOD-1038
4. Forward Operation Life	Rated average rectifier current at $T_A=25^\circ\text{C}$ for 500hrs.	MIL-STD-750D METHOD-1027
5. Intermittent Operation Life	$T_A = 25^\circ\text{C}$ , $I_F = I_O$ On state: power on for 5 min. off state: power off for 5 min. on and off for 500 cycles.	MIL-STD-750D METHOD-1036
6. Pressure Cooker	15P <sub>SIG</sub> at $T_A=121^\circ\text{C}$ for 4 hrs.	JESD22-A102
7. Temperature Cycling	-55°C to +125°C dwelled for 30 min. and transferred for 5min. total 10 cycles.	MIL-STD-750D METHOD-1051
8. Forward Surge	Peak Forward Surge Current	MIL-STD-750D METHOD-4066-2
9. Humidity	at $T_A=85^\circ\text{C}$ , RH=85% for 1000hrs.	MIL-STD-750D METHOD-1021
10. High Temperature Storage Life	at 175°C for 1000 hrs.	MIL-STD-750D METHOD-1031