



Technical Data Sheet

RGB Color Sensor SMD Device

Preliminary

CLS15-22C/L213(R、G、B)/TR8

Features

- Package in 8mm tape on 7" diameter reel.
- Surface-mount plastic package.
- Good stable output with temperature shift.
- External dimensions 3.2(L)*2.7(W)*1.1(H)mm³.
- Compatible with automatic placement equipment.
- Compatible with infrared and vapor phase reflow solder process.
- Built in 1-Channel/1Chip (R, G, B) Si photodiode.
- Active area: 1.8 mm²
- Pb free
- The product itself will remain within RoHS compliant version.

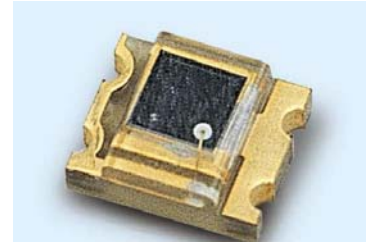

Descriptions

CLS15-22C/L213(R、G、B)/TR8 Color Sensor Device, consisting of 1-Channel/1Chip (R, G, B) Si photodiode, is a good effective solution to color balance of display backlighting appliances, such as the LCD TV and projector. The color sensor sensitive are Red ($\lambda_p=620\text{nm}$), Green ($\lambda_p=550\text{nm}$) and Blue ($\lambda_p=470\text{nm}$) regions of the spectrum.

Applications

- Color adjustment for LED back light system for LCD.
- Color adjustment for LCD projector
- Color tester and Color temperature detection.
- White balance : Camera

Device Selection Guide

| PART | MATERIAL | COLOR |
|---------|----------|-------------|
| Chip | Silicon | --- |
| Package | Epoxy | Water Clear |

Package Dimensions

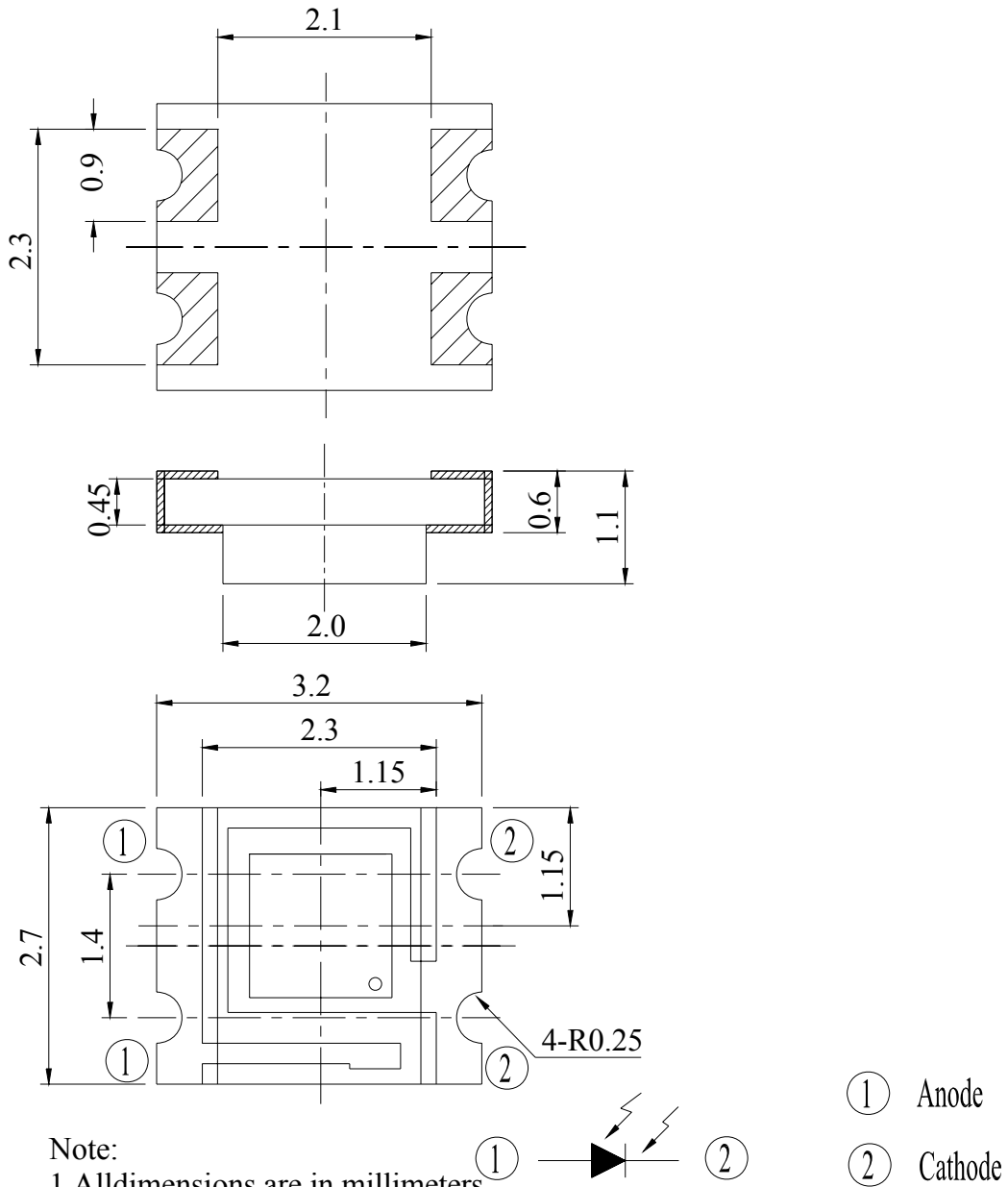

Note:
 1. All dimensions are in millimeters.
 2. Tolerances unless dimension ± 0.1 mm

Absolute Maximum Ratings (Ta=25°C)

| Parameter | Symbol | Condition | Rating | Units |
|---------------------------|------------------|-------------------------|-----------|-------|
| Reverse Breakdown Voltage | V _{BR} | I _R = 100 μA | 35 | V |
| Forward Voltage | V _F | I _F = 10mA | 0.5~1.3 | V |
| Operating Temperature | T _{opr} | --- | -25 ~ +85 | °C |
| Storage Temperature | T _{stg} | --- | -40 ~ +85 | °C |
| Soldering Temperature | T _{sol} | --- | 260 | °C |

Notes: *1:Soldering time ≤ 5 seconds.

Electro-Optical Characteristics (Ta=25°C)

Red Light Sensor Device : CLS15-22C/L213R/TR8

| Parameter | Symbol | Condition | Min | Typ | Max | Unit |
|-----------------------------|-----------------|---|-----|-------|-----|------|
| Peak Sensitivity Wavelength | λ _p | --- | --- | 620 | --- | nm |
| Short-Circuit Current | I _{SC} | Ee=100Lux ^[1] V _R =0V | --- | 0.086 | --- | μA |
| Reverse Light Current(1) | I _{L1} | Ee=100Lux ^[1] V _R =5V | --- | 0.091 | --- | μA |
| Reverse Light Current(2) | I _{L2} | Ee=1000Lux ^[1] V _R =5V | --- | 0.83 | --- | μA |
| Reverse Dark Current | I _D | Ee=0 V _R = 10 V | --- | 2 | 10 | nA |

Note:

[1]: White Fluorescent light (Color Temperature = 6500K) is used as light source.

CLS15-22C/L213(R、G、B)/TR8

Green Light Sensor Device : CLS15-22C/L213G/TR8

| Parameter | Symbol | Condition | Min | Typ | Max | Unit |
|-----------------------------|-------------|---|-----|-------|-----|---------|
| Peak Sensitivity Wavelength | λ_p | --- | --- | 550 | --- | nm |
| Short-Circuit Current | I_{SC} | Ee=100Lux ^[1] V _R =0V | --- | 0.075 | --- | μA |
| Reverse Light Current(1) | I_{L1} | Ee=100Lux ^[1] V _R =5V | --- | 0.082 | --- | μA |
| Reverse Light Current(2) | I_{L2} | Ee=1000Lux ^[1] V _R =5V | --- | 0.72 | --- | μA |
| Reverse Dark Current | I_D | Ee=0 Lux V _R = 10 V | --- | 2 | 10 | nA |

Blue Light Sensor Device : CLS15-22C/L213B/TR8

| Parameter | Symbol | Condition | Min | Typ | Max | Unit |
|-----------------------------|-------------|--|-----|-------|-----|---------|
| Peak Sensitivity Wavelength | λ_p | --- | --- | 470 | --- | nm |
| Short-Circuit Current | I_{SC} | 100Lux ^[1] V _R =0V | --- | 0.042 | --- | μA |
| Reverse Light Current(1) | I_{L1} | 100Lux ^[1] V _R =5V | --- | 0.046 | --- | μA |
| Reverse Light Current(2) | I_{L2} | 1000Lux ^[1] V _R =5V | --- | 0.39 | --- | μA |
| Reverse Dark Current | I_D | V _R = 10 V | --- | 2 | 10 | nA |

Typical Electro-Optical Characteristics Curves
CLS15-22C/L213R/TR8

Fig.1 Dark Current vs. Ambient Temperature

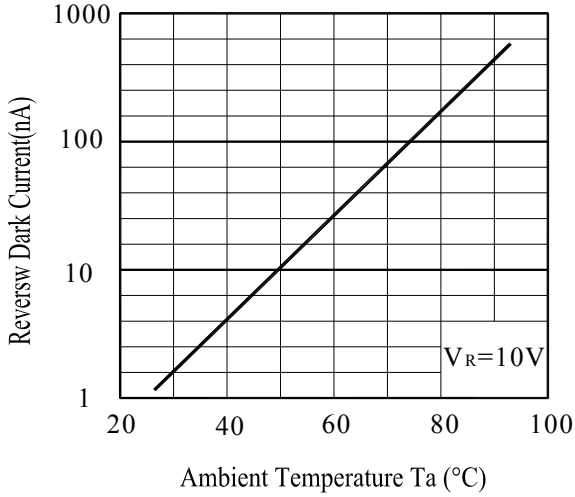

Fig.2 Illuminance vs. Output Photocurrent

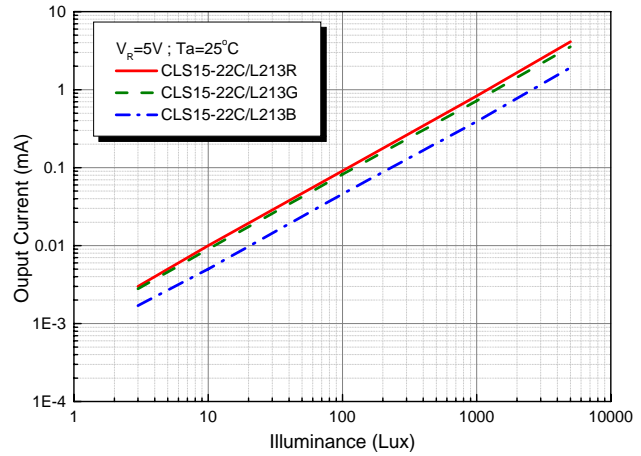

Fig.-3 R,G, B LED Test vs. Output Photocurrent

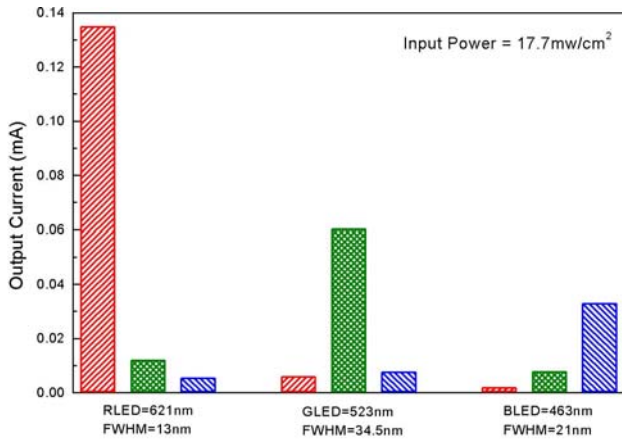

Fig.-3 R,G, B LED Test vs. Output Photocurrent

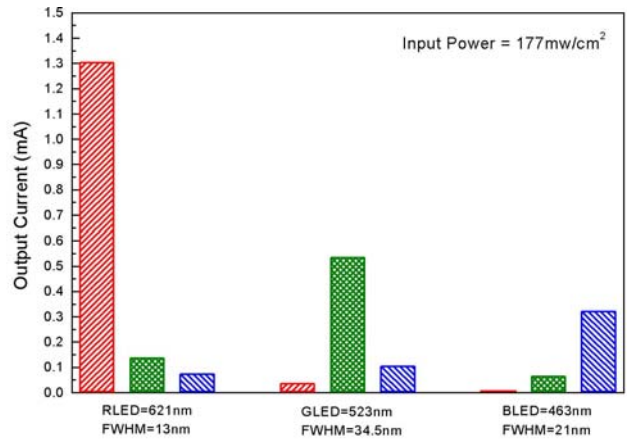
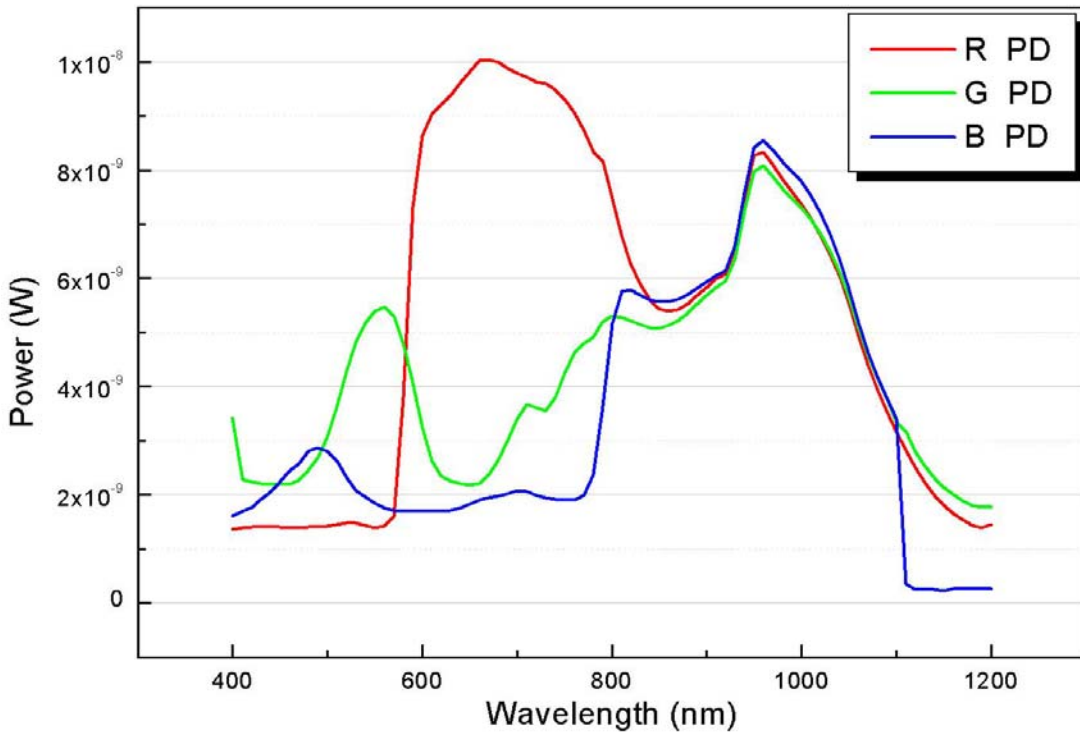

Fig.3 Relative Sensitivity vs. Wave Length(nm)



Packing Quantity Specification

- 1. 2000 PCS/1 Reel
- 2. 5 Reel /1Carton

Label explanation

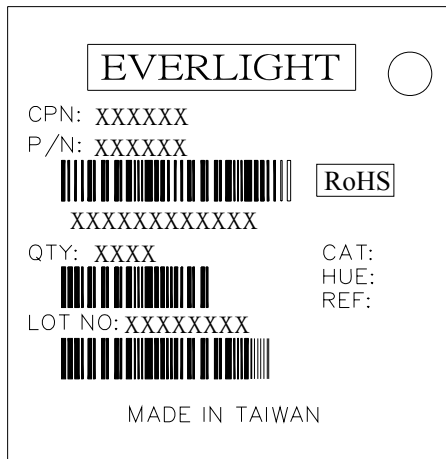

CPN: Customer's Production Number
 P/N : Production Number
 QTY: Packing Quantity
 CAT: Ranks
 HUE: None
 REF: Reference
 LOT No: Lot Number
 MADE IN TAIWAN: Production Place

Reel Dimensions

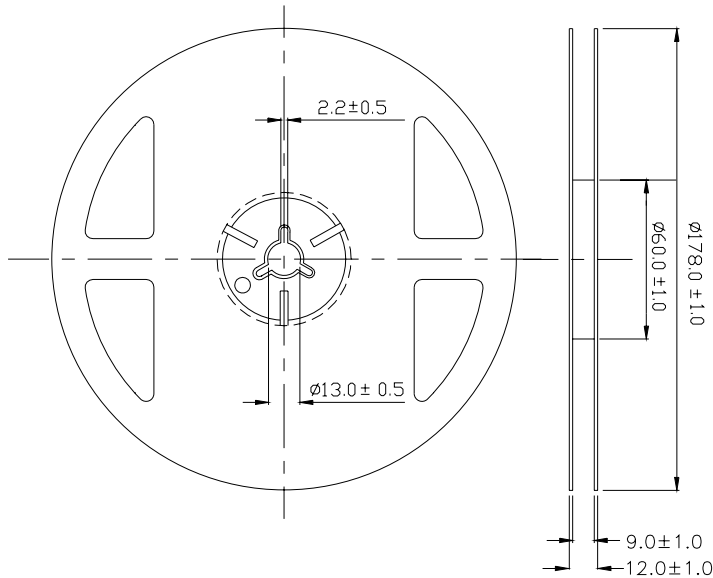

Note: The tolerances unless mentioned are ±0.1, Unit = mm.

Carrier Tape Dimensions: Loaded quantity 2000 PCS per reel

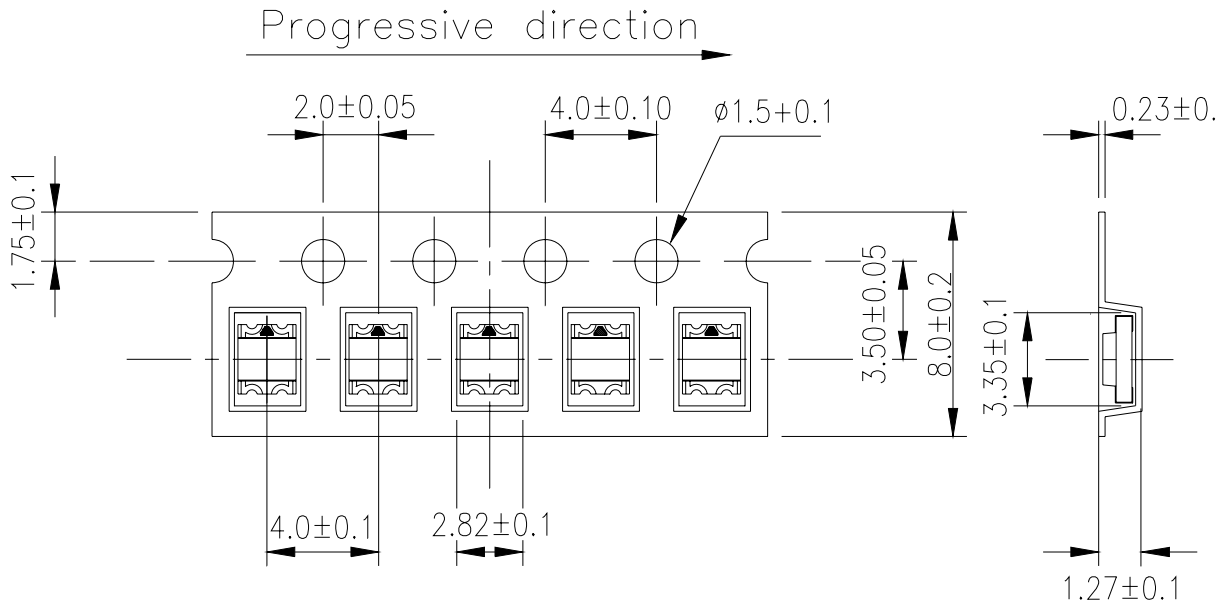

Note: Tolerances Unless Dimension is $\pm 0.1\text{mm}$, Unit = mm

Moisture Resistant Packaging

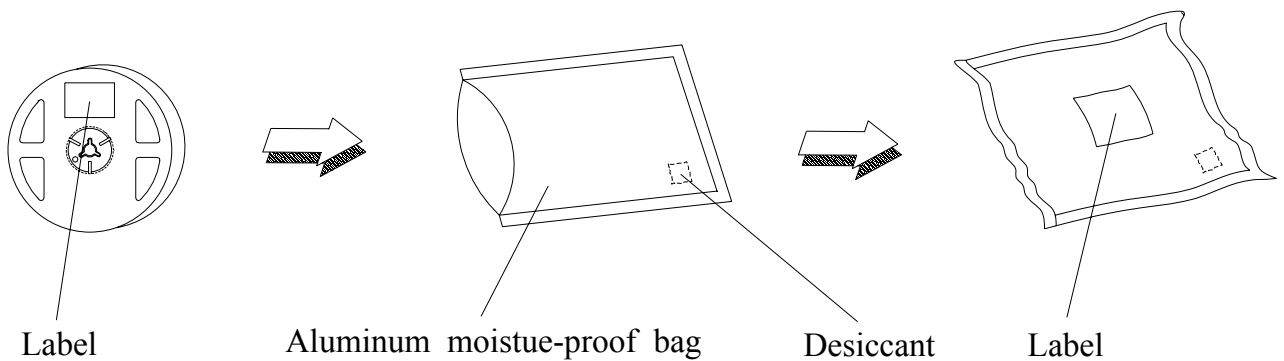

Notes

1. Above specification may be changed without notice. EVERLIGHT will reserve authority on material change for above specification.
2. When using this product, please observe the absolute maximum ratings and the instructions for using outlined in these specification sheets. EVERLIGHT assumes no responsibility for any damage resulting from use of the product which does not comply with the absolute maximum ratings and the instructions included in these specification sheets.
3. These specification sheets include materials protected under copyright of EVERLIGHT corporation. Please don't reproduce or cause anyone to reproduce them without EVERLIGHT's consent.

EVERLIGHT ELECTRONICS CO., LTD.
Office: No 25, Lane 76, Sec 3, Chung Yang Rd,
Tucheng, Taipei 236, Taiwan, R.O.C

Tel: 886-2-2267-2000, 2267-9936
Fax: 886-2267-6244, 2267-6189, 2267-6306
<http://www.everlight.com>