

規格承認書

SPECIFICATION FOR APPROVAL

客戶
CUSTOMER : 立創
項目
ITEM : 电磁式蜂鸣器 (外部驱动式)
型號
TYPE : BL-PBZ1209C2005YB-H
客戶料號
CUSTOMER NO. :
規格書號
SPECIFICATION NO. :
版本
EDITION NO. : 1.1
日期
DATE : 2018-7-20

客戶認可

CUSTOMER'S APPROVED SIGNATURE

--	--	--

東莞市博林電子有限公司

DONGGUAN BOLIN ELECTRONICS CO.,LTD

<http://www.bolin.com.hk>

地址：廣東省東莞市長安鎮鑫偉潤高新科技产业园

Address: XinWeiRun high tech Industrial Park , Chang'an Town, DongGuan City,GuangDong Province,China

電話專線/TEL:0769- 81871887 傳真/FAX:0769-81769981

確認 APPROVED BY	審查 CHECKED BY	製作 ISSUED BY
	石磊	zhang

DONGGUAN BOLIN ELECTRONICS CO.,LTD

DIMENSIONS Unit:mm Tolerance: ± 0.5

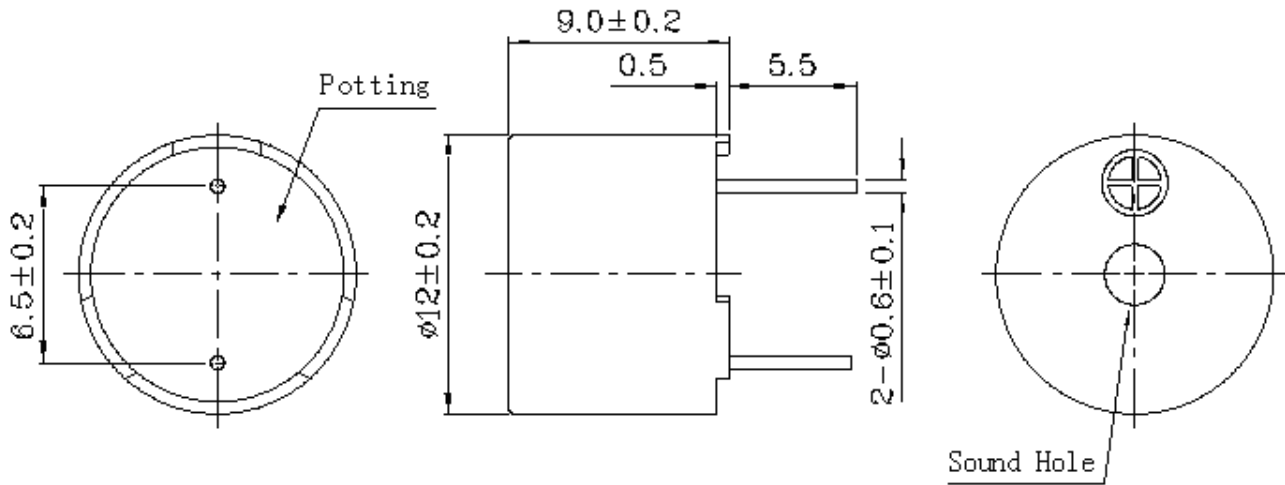

SPECIFICATIONS

Model NO	BL-PBZ1209C2005YB-H
Rated Voltage	5.0Vo-p
Operating Voltage	4.0~7.0Vo-p
Rated Current at 5Vo-p/2048HZ	Max.50mA
Sound Pressure level(dB)at 5Vo-p/2048HZ/10cm	Min.85dB
Resonant Frequency	2048Hz
Coil Resistance	42 ± 6
Operating Temperature	-20 °C ~ +70 °C
Storage Temperature	-30 °C ~ +80 °C

备注: (1) 建议蜂鸣器正常使用电流 40~45mA
 (2) 建议波峰焊接温度: 255 ± 5 度, 时间: 3-5 秒.

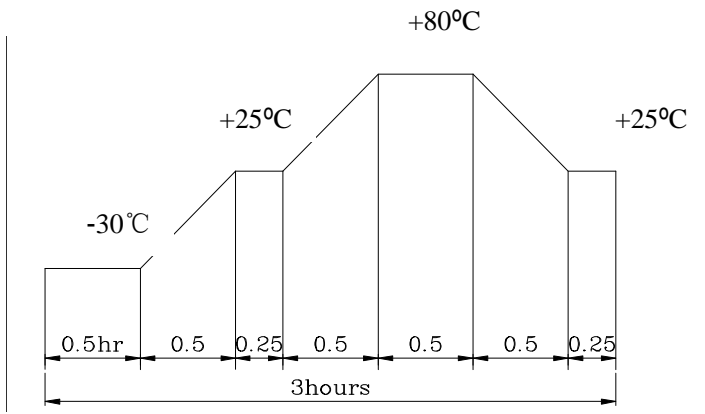
NO.	ITEM	TEST CONDITION AND REQUIREMENT
1	High Temperature Test (Storage)	After being placed in a chamber with $80 \pm 2^\circ\text{C}$ for 48 hours and then being placed in normal condition for 2 hours. Allowable variation of SPL after test: $\pm 10\text{dB}$.
2	Low Temperature Test (Storage)	After being Placed in a chamber with $-30 \pm 2^\circ\text{C}$ for 48 hours and then being placed in normal condition for 2 hours. Allowable variation of SPL after test: $\pm 10\text{dB}$.
3	Humidity Test	After being Placed in a chamber with 80-85% R.H. at $40 \pm 2^\circ\text{C}$ for 48 hours and then being placed in normal condition for 2 hours. Allowable variation of SPL after test: $\pm 10\text{dB}$.
4	Temperature Cycle Test	<p>The part shall be subjected to 5 cycles. One cycle shall be consist of:</p>  <p>and then being placed in normal condition for 2 hours. Allowable variation of SPL after test: $\pm 10\text{dB}$.</p>
5	Solderability Test	Lead terminals are immersed in rosin for 3 seconds and then immersed in solder bath of $+320 \pm 10^\circ\text{C}$ for 3 seconds . 90% min. lead terminals shall be wet with solder (Except the edge of terminals).
6	Terminal Strength Pulling Test	The force of 5N is applied to each terminal in axial direction for 5 seconds. No visible damage and cutting off.

TEST CONDITION.

Standard Test Condition : a) Temperature : $+5 \sim +35^\circ\text{C}$ b) Humidity : 45-85% c) Pressure : 860-1060mbar
一般测试条件 : a) 温度 : $+5 \sim +35^\circ\text{C}$ b) 湿度 : 45-85% c) 气压 : 860-1060mbar
Judgment Test Condition : a) Temperature : $+25 \pm 2^\circ\text{C}$ b) Humidity : 60-70% c) Pressure 860-1060mbar
争议时测试条件 : a) 温度 : $+25 \pm 2^\circ\text{C}$ b) 湿度 : 60-70% c) 气压 : 860-1060mbar