

DIP SWITCH DHN(F) SERIES

1.6mm
Half Pitch Type

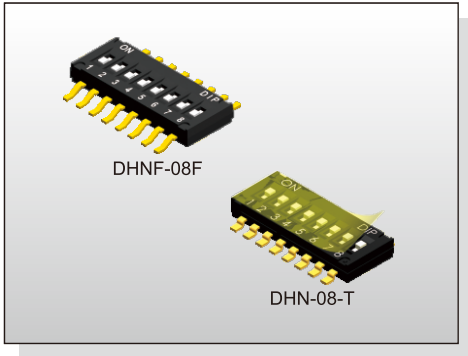

FEATURES

- ※Low profile 1.6mm height
- ※Gold contact for high reliability
- ※Top tape type for washing process

APPLICATION

- ※Industrial control
- ※Automatic machines control
- ※NB, electronic devices

SPECIFICATION

Contact Rating	25mA, 24V DC
Contact Resistance	100mΩ max.
Insulation Resistance	100MΩ min. 500V DC
Dielectric Strength	300V AC/1 minute
Operating Force	500gf max.
Travel	0.6mm
Operating Life	1,000 cycles
Operating Temp.	-40°C ~ +85°C
Storage Temp.	-40°C ~ +85°C

CIRCUIT

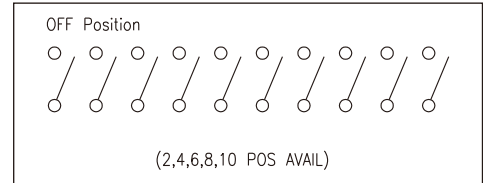

HOW TO ORDER

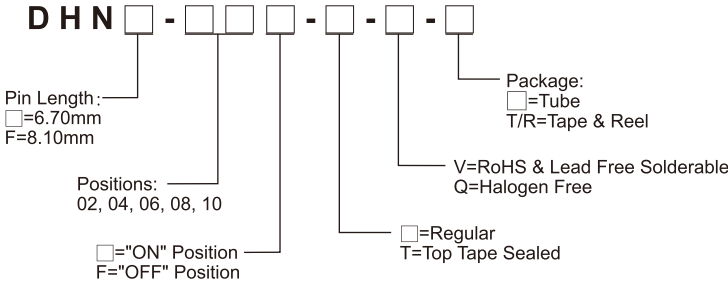

PACKAGE

- <Tube>
 DHN(F)-02: 125 pcs
 DHN(F)-04: 75 pcs
 DHN(F)-06: 54 pcs
 DHN(F)-08: 40 pcs
 DHN(F)-10: 33 pcs
- <Tape & Reel>
 DHN: 4000 pcs
 DHNF: 2500 pcs

DHN

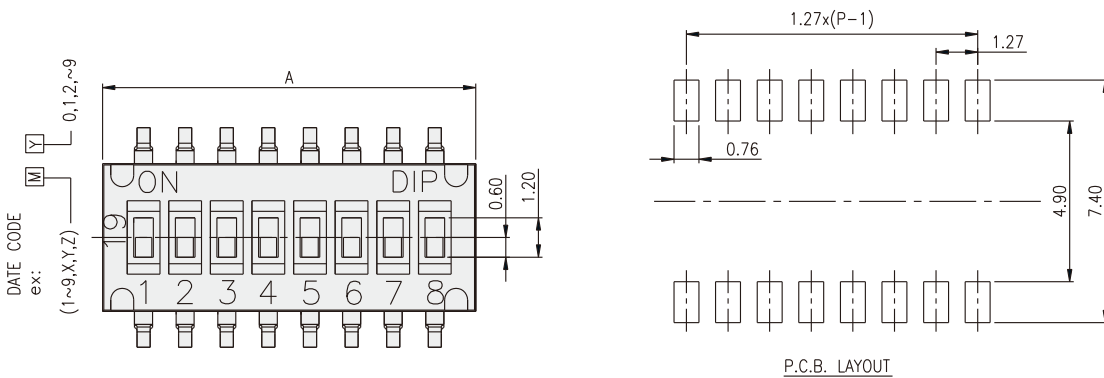

PART NO.	NO.OF POS	DIM A
DHN-02	2	3.77
DHN-04	4	6.31
DHN-06	6	8.85
DHN-08	8	11.39
DHN-10	10	13.93

DHNF

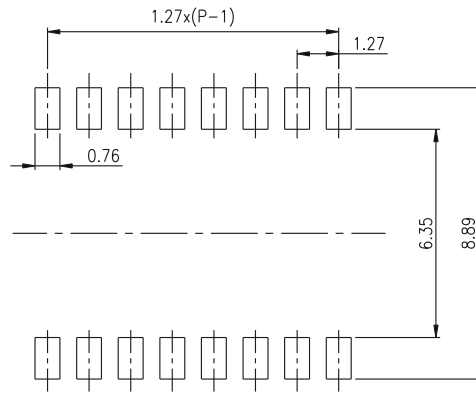
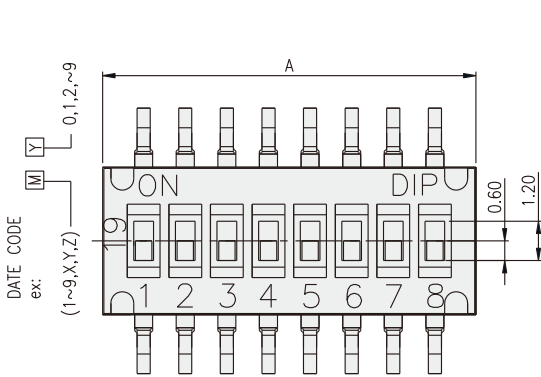

P.C.B. LAYOUT

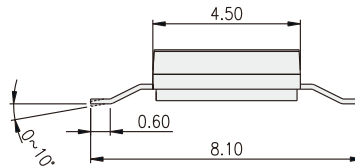
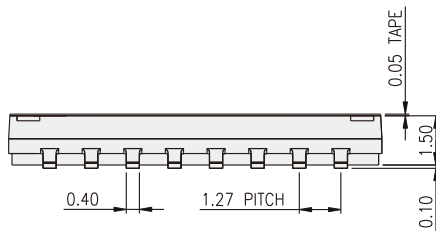

PART NO.	NO.OF POS	DIM A
DHNF-02	2	3.77
DHNF-04	4	6.31
DHNF-06	6	8.85
DHNF-08	8	11.39
DHNF-10	10	13.93