



# CED20P10/CEU20P10

## P-Channel Enhancement Mode Field Effect Transistor

PRELIMINARY

### FEATURES

- -100V, -16A,  $R_{DS(ON)} = 130m\Omega$  @  $V_{GS} = -10V$ .
- Super high dense cell design for extremely low  $R_{DS(ON)}$ .
- High power and current handling capability.
- Lead-free plating ; RoHS compliant.
- TO-251 & TO-252 package.

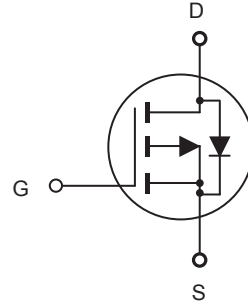

### ABSOLUTE MAXIMUM RATINGS $T_C = 25^\circ C$ unless otherwise noted

Parameter	Symbol	Limit	Units
Drain-Source Voltage	$V_{DS}$	-100	V
Gate-Source Voltage	$V_{GS}$	$\pm 20$	V
Drain Current-Continuous	$I_D$	-16	A
Drain Current-Pulsed <sup>a</sup>	$I_{DM}$	-64	A
Maximum Power Dissipation @ $T_C = 25^\circ C$ - Derate above $25^\circ C$	$P_D$	75	W
		0.5	W/ $^\circ C$
Single Pulsed Avalanche Energy <sup>e</sup>	$E_{AS}$	128	mJ
Single Pulsed Avalanche Current <sup>e</sup>	$I_{AS}$	16	A
Operating and Store Temperature Range	$T_J, T_{stg}$	-55 to 175	$^\circ C$

### Thermal Characteristics

Parameter	Symbol	Limit	Units
Thermal Resistance, Junction-to-Case	$R_{\theta JC}$	2	$^\circ C/W$
Thermal Resistance, Junction-to-Ambient	$R_{\theta JA}$	50	$^\circ C/W$

This is preliminary information on a new product in development now .  
 Details are subject to change without notice

Rev 1. 2012.Feb  
<http://www.cetsemi.com>



# CED20P10/CEU20P10

## Electrical Characteristics $T_A = 25^\circ\text{C}$ unless otherwise noted

Parameter	Symbol	Test Condition	Min	Typ	Max	Units
<b>Off Characteristics</b>						
Drain-Source Breakdown Voltage	$BV_{DSS}$	$V_{GS} = 0V, I_D = -250\mu A$	-100			V
Zero Gate Voltage Drain Current	$I_{DSS}$	$V_{DS} = -100V, V_{GS} = 0V$			-1	$\mu A$
Gate Body Leakage Current, Forward	$I_{GSSF}$	$V_{GS} = 16V, V_{DS} = 0V$			100	nA
Gate Body Leakage Current, Reverse	$I_{GSSR}$	$V_{GS} = -16V, V_{DS} = 0V$			-100	nA
<b>On Characteristics <sup>c</sup></b>						
Gate Threshold Voltage	$V_{GS(th)}$	$V_{GS} = V_{DS}, I_D = -250\mu A$	-2		-4	V
Static Drain-Source On-Resistance	$R_{DS(on)}$	$V_{GS} = -10V, I_D = -8A$		110	130	m $\Omega$
<b>Dynamic Characteristics <sup>d</sup></b>						
Input Capacitance	$C_{iss}$	$V_{DS} = -25V, V_{GS} = 0V, f = 1.0 \text{ MHz}$		1260		pF
Output Capacitance	$C_{oss}$			210		pF
Reverse Transfer Capacitance	$C_{rss}$			40		pF
<b>Switching Characteristics <sup>d</sup></b>						
Turn-On Delay Time	$t_{d(on)}$	$V_{DD} = -50V, I_D = -16A, V_{GS} = -10V, R_{GEN} = 25\Omega$		22	44	ns
Turn-On Rise Time	$t_r$			16	32	ns
Turn-Off Delay Time	$t_{d(off)}$			85	170	ns
Turn-Off Fall Time	$t_f$			29	58	ns
Total Gate Charge	$Q_g$	$V_{DS} = -80V, I_D = -16A, V_{GS} = -10V$		30	39	nC
Gate-Source Charge	$Q_{gs}$			6		nC
Gate-Drain Charge	$Q_{gd}$			12		nC
<b>Drain-Source Diode Characteristics and Maximum Ratings</b>						
Drain-Source Diode Forward Current <sup>b</sup>	$I_S$				-16	A
Drain-Source Diode Forward Voltage <sup>c</sup>	$V_{SD}$	$V_{GS} = 0V, I_S = -16A$			-1.2	V
<b>Notes :</b> □ a.Repetitive Rating : Pulse width limited by maximum junction temperature.□ b.Surface Mounted on FR4 Board, $t \leq 10 \text{ sec.}$ □ c.Pulse Test : Pulse Width $\leq 300\mu s$ , Duty Cycle $\leq 2\%$ .□ d.Guaranteed by design, not subject to production testing.□ e.L = 1mH, $I_{AS} = 16A$ , $V_{DD} = 25V$ , $R_G = 25\Omega$ , Starting $T_J = 25 \text{ C}$ □						



# CED20P10/CEU20P10

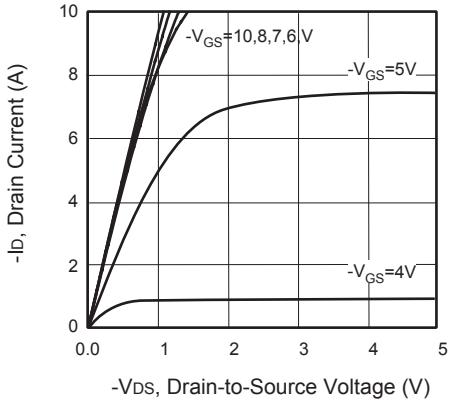

Figure 1. Output Characteristics

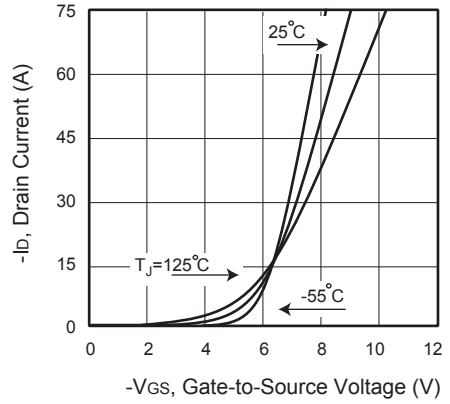

Figure 2. Transfer Characteristics

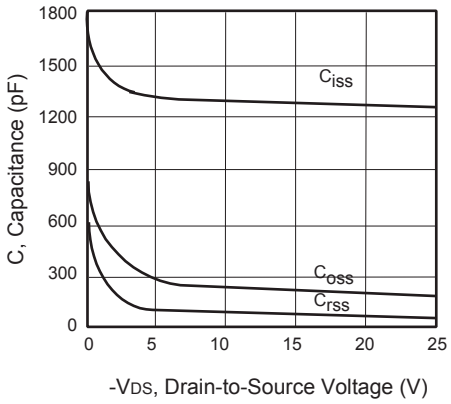

Figure 3. Capacitance

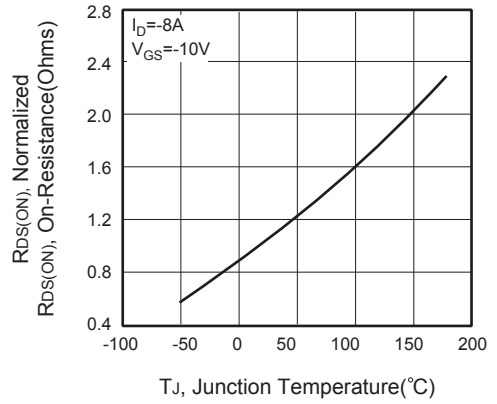

Figure 4. On-Resistance Variation with Temperature

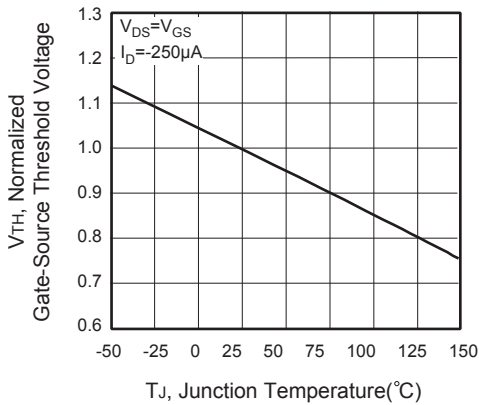

Figure 5. Gate Threshold Variation with Temperature

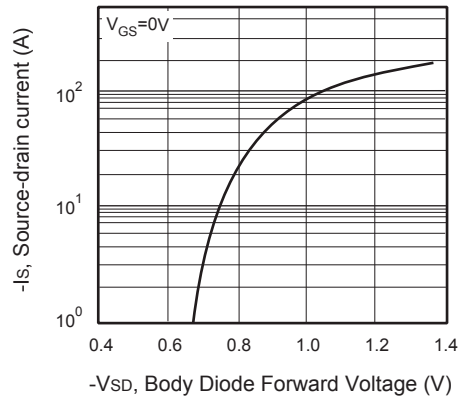

Figure 6. Body Diode Forward Voltage Variation with Source Current



# CED20P10/CEU20P10

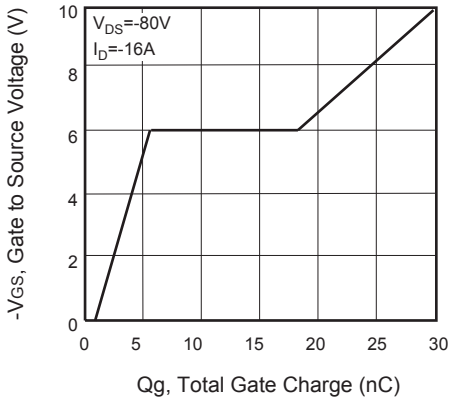

Figure 7. Gate Charge

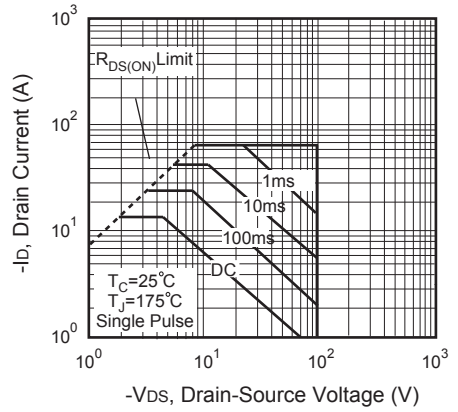

Figure 8. Maximum Safe Operating Area

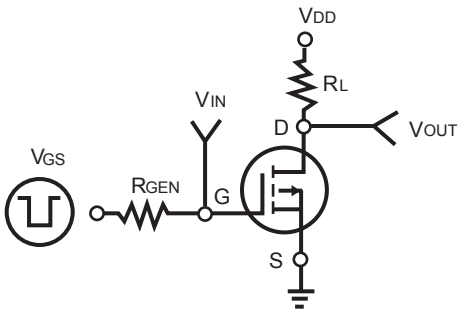

Figure 9. Switching Test Circuit

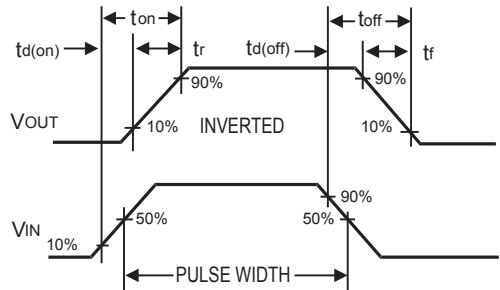

Figure 10. Switching Waveforms

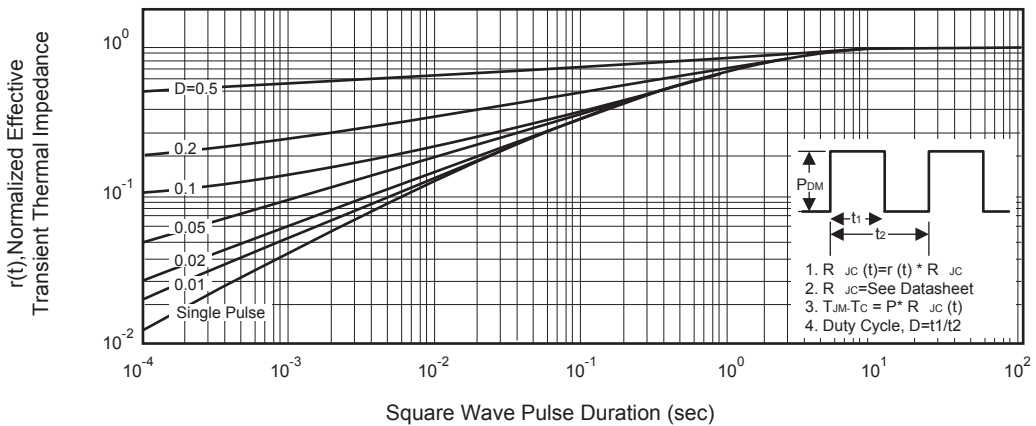

Figure 11. Normalized Thermal Transient Impedance Curve