

Powder Molding Type

BCIHP0412/18/20/30 Series

● Photograph picture

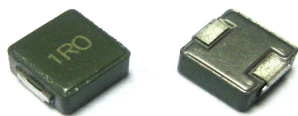

● Dimensions

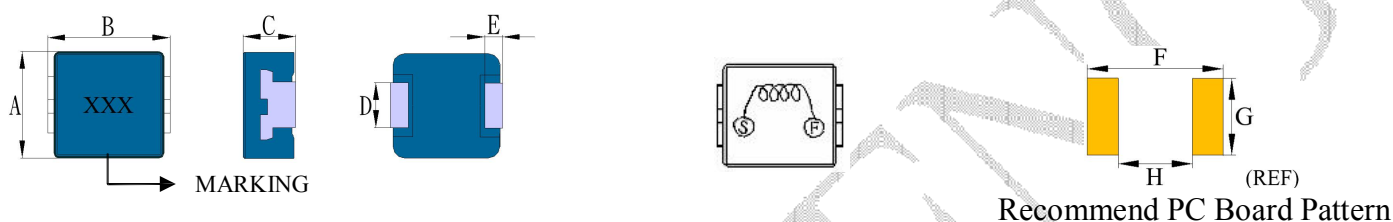

ITEM	A(mm)	B(mm)	C(mm)	D(mm)	E(mm)	F(mm)	G(mm)	H(mm)
BCIHP0412-Series	4.10±0.25	4.45±0.25	1.2MAX	1.60±0.3	0.76±0.3	4.95	1.95	1.60
BCIHP0418-Series	4.10±0.25	4.45±0.25	1.8MAX	1.60±0.3	0.76±0.3	4.95	1.95	1.60
BCIHP0420-Series	4.10±0.25	4.45±0.25	2.0MAX	1.60±0.3	0.76±0.3	4.95	1.95	1.60
BCIHP0420TB-Series	4.10±0.25	4.45±0.25	2.0MAX	1.60±0.3	0.76±0.3	4.95	1.95	1.60
BCIHP0430-Series	4.10±0.25	4.45±0.25	3.0MAX	1.60±0.3	0.76±0.3	4.95	1.95	1.60

● Part Numbering

BCIHP 0410 - 4R7 M
A B C D

A:Series(系列代號)

B:Dimension(尺寸)

C:Inductance(電感值)

D:Inductance Tolerance(電感值公差)

B×C

4R7=4.7uH

M=±20%

● Features

1. Compliance with RoHs.
2. Lowest DCR.
3. Frequency range up to 3.0MHz.
Height 1.0~1.5mm frequency of 1.0 MHz
4. Handles high transient current spikes without saturation
5. Ultra low buzz noise, due to composite construction.

● Applications

1. Notebook/Desktop/Server applications.
2. Low profile, high current power supplies.
3. Battery powered devices.
4. DC/DC converter for Field Programmable Gate Array (FPGA).

● 特點

1. 符合 RoHs.
2. 低電阻.
3. 頻率可達到 3.0 MHz..
高度 1.0~1.5mm 頻率為 1.0 MHz
4. 可處理在未飽和時的高瞬間電流.
5. 設計緊湊/超低噪音

● 應用

1. 筆記本型電腦/伺服器設.
2. 備形體小, 可耐高電流.
3. 電源, 電池設備.
4. 用於 FPGA 領域中的 DC/DC 轉換設備

Powder Molding Type

BCIHP0412/18/20/30 Series

● Specification

ITEM	INDUCTANCE μ H @200KHZ,0.25V,0A(1)	DCR $m\Omega$ 25°C MAX.	DCR $m\Omega$ 25°C Typ.	HEAT RATING CURRENT DC AMPS (5) TYPICAL(Irms)	SATURATION CURRENT DC AMPS (6) TYPICAL(Isat)
BCIHP0412-R047N _[IHL-1616AB-01/11]	0.047	3.75	3.10	13.00 _[11]	32.00
BCIHP0412-R10N _[IHL-1616AB-01/11]	0.10	10.2	7.5	8.00	25.00
BCIHP0412-R15N _[IHL-1616AB-01/11]	0.15	13.2	9.4	7.00	23.00
BCIHP0412-R20N _[IHL-1616AB-01/11]	0.20	13.2	9.4	7.00	23.00
BCIHP0412-R22N _[IHL-1616AB-01]	0.22	12.00	9.9	8.50	15.00
BCIHP0412-R47M _[IHL-1616AB-01]	0.47	22.00 _[5]	19.50	6.00	7.00
BCIHP0412-R68M _[IHL-1616AB-01]	0.68	39.00	33.5	5.00	9.00
BCIHP0412HC-1R0M _[IHL-1616AB-01]	1.00	47.00	41.5	4.20	4.50
BCIHP0412HC-1R2M _[IHL-1616AB-01]	1.20	55.00	50.00	3.75	3.75
BCIHP0412HC-1R5M _[14]	1.50	75.00	66.00	3.25	3.25
BCIHP0412HC-2R2M	2.20	100.00	91.5	2.75	3.00
BCIHP0412-3R3M	3.30	185.00	155.00	2.00	2.30
BCIHP0412-4R7M	4.70	246.00	225.00	1.80	2.00
BCIHP0412-6R8M	6.80	360.00	325.00	1.50	1.70
BCIHP0412-100M	10.00	550.00	515.00	1.20 _[9]	1.50 _[9]
BCIHP0418-R20M	0.20	11.00	7.80	8.00	9.00
BCIHP0418-R47M	0.47	18.50	16.50	6.00	8.00
BCIHP0418-R80N	0.80	33.00	25.50	5.00	6.00
BCIHP0418-1R0M	1.00	42.00	32.00	4.50	5.50
BCIHP0420-R10N _[IHL-1616BZ-01]	0.10	5.00	4.40	11.0 _[12]	28.00
BCIHP0420-R20N _[IHL-1616BZ-01]	0.20	7.80	11.0	8.00 _[12]	9.00 _[12]
BCIHP0420-R22N _{[15] [IHL-1616BZ-01]}	0.22	7.30	6.60	9.00	12.50
BCIHP0420-R47M _[IHL-1616BZ-01]	0.47	18.00	15.00	7.00 _[1]	8.00 _[1]
BCIHP0420-R56M	0.56	21.30	17.80	6.50	7.80
BCIHP0420-R68M	0.68	26.00	21.50	6.00	7.50
BCIHP0420-1R0M _[IHL-1616BZ-01]	1.00	42.00 _[12]	31.50 _[1]	4.50 _[1]	7.00 _[1]
BCIHP0420-1R2M	1.20	46.00	40.00	3.50	7.50
BCIHP0420HC-1R5M	1.50	63.00	53.50	3.30	4.00
BCIHP0420HC-2R2M _[IHL-1616BZ-01]	2.20	58.00	47.00	3.00	5.00 _[12]
BCIHP0420-3R3M	3.30	106.00	90.00	2.50	3.00
BCIHP0420-4R7M	4.70	132.00	120.00	2.40	3.00
BCIHP0420-6R8M	6.80	202.00	185.00	2.00	2.50
BCIHP0420-8R2M	8.20	255.00	232.00	1.60	1.80
BCIHP0420-100M	10.00	282.00	252.00	1.60	1.80 _[16]
BCIHP0420-220M _[17]	22.00	640.00	590.00	1.20	1.40

Powder Molding Type

BCIHP0412/18/20/30 Series

● Specification

ITEM	INDUCTANCE uH @200KHZ,0.25V,0A(1)	DCR mΩ 25°C MAX.	DCR mΩ 25°C Typ.	HEAT RATING CURRENT DC AMPS (5) TYPICAL(Irms)	SATURATION CURRENT DC AMPS (6) TYPICAL(Isat)
BCIHP0420TB-R22N _[IHL P-1616BZ-11]	0.22	6.60	6.00	9.00	12.50
BCIHP0420TB-R33M	0.33	13.00	10.50	10.0	12.00
BCIHP0420TB-R47M _[IHL P-1616BZ-11]	0.47	14.00	12.50	7.00	9.50
BCIHP0420TB-R68M	0.68	26.00	19.50	6.00	7.50
BCIHP0420TB-1R0M _[IHL P-1616BZ-11]	1.00	27.00	23.50	4.50	7.00
BCIHP0420TB-1R2M _{PCMB042T-1R2MS}	1.20	29.00	25.00	4.50	7.00
BCIHP0420TB-1R5M _{PCMB042T-1R5MS}	1.50	46.00	41.50	4.00	6.00
BCIHP0420TB-2R2M _{PCMB042T-2R2MS}	2.20	58.00	52.50	3.00 _[13]	5.00
BCIHP0420TB-3R3M _[IHL P-1616BZ-11]	3.30	87.00	80.00	2.50	4.00
BCIHP0420TB-4R7M _{[17][IHL P-1616BZ-11]}	4.70	110.00	92.50	2.00	3.50
BCIHP0420TB-5R6M _[17]	5.60	125.00	107.50	2.20	3.00
BCIHP0420TB-6R8M _[17]	6.80	172.00	150.00	2.10	2.80
BCIHP0430-R47M	0.47	16.00	15.00	7.50	8.50
BCIHP0430-R56M	0.56	19.30	16.50	7.00	8.00
BCIHP0430-1R0M	1.00	43.50	38.80	3.50	5.00
BCIHP0430-1R5M	1.50	63.80	49.00	4.00	4.50
BCIHP0430-2R2M	2.20	65.00	55.00	4.00	4.00

Note:

- (1) Tolerance of Inductance: N=±30% ,M=±20%.
- (2) All test data is referenced to 25°C ambient.
- (3) Inductance is measured at 200KHz. 25°C ambient.
- (4) Operating Temperature Range-40°C to +125°C.
- (5) DC current (I_{rms}) (A) that will cause an approximate ΔT of 40°C.
- (6) DC current (I_{sat}) (A) that will cause L_o to drop approximately 20%.
- (7) BCIHP0410/BCIHP0420TB-Series DC current (I_{sat}) (A) that will cause L_o to drop approximately 30%.
- (8) The part Temperature (ambient + temp rise) should not exceed 125°C under worst case operating conditions.

Circuit design, component placement, PWB trace size and thickness, airflow and other cooling provisions all affect the part temperature Part temperature should be verified in the end application.

- (1) 電感的公差：N=±30%，M=±20%。
- (2) 所有的測試資料應該是在 25°C 的環境溫度下測試。
- (3) 感值測試頻率 200KHz。
- (4) 操作溫度範圍 -40°C 到 +125°C。
- (5) 加 DC (I_{rms}) 電流值 (A) 會導致 ΔT 40°C 左右的變化。
- (6) 加 DC (I_{sat}) 電流值 (A) 會導致初始值下降 20% 左右。
- (7) BCIHP0410/BCIHP0420TB-Series 加 DC (I_{sat}) 電流值 (A) 會導致初始值下降 30% 左右。
- (8) 產品的溫度不能超過 125°C，即使在最壞的操作情況下，基板設計，元件放置，PWB 尺寸和厚度，氣流和一些冷卻設備都會影響產品溫度，產品溫度要在最終應用時才被驗證。

Powder Molding Type

BCIHP0412/18/20/30 Series

● Material List



NO	ITEM	Materials
1	Core	Magnetic Metal Powder or equivalent
2	Wire	Polyester Wire or equivalent
3	External Electrode	Copper
	Electroplating	Ni/Sn
4	Paint	Epoxy resin

● Packaging Information

(1) Reel Dimension & Tape Dimension / Packaging Quantity.

Reel Dimensions

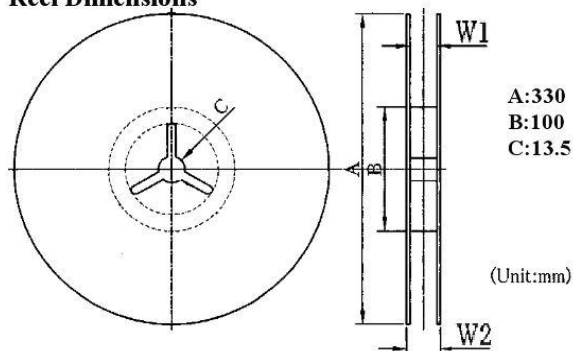

Tape Dimensions

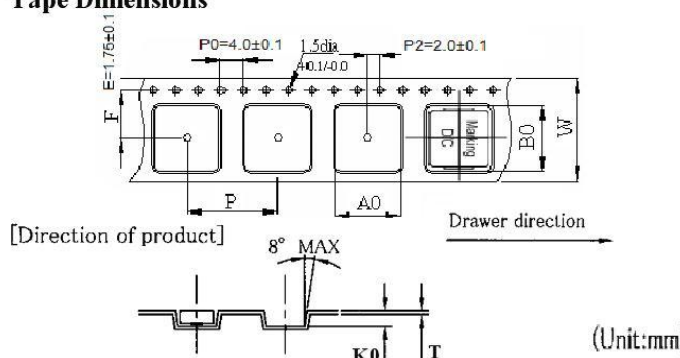

ITEM	Q'TY (PCS)	DIMENSIONS (m/m)								
		W1±0.3	W2±0.5	W±0.3	A0±0.1	B0±0.1	K0±0.1	P±0.1	F±0.1	T±0.05
BCIHP0412	4,000	12.80	17.00	12.00	4.30	4.60	1.50	8.00	5.50	0.30
BCIHP0418	3,000	12.80	17.00	12.00	4.30	4.60	2.20	8.00	5.50	0.30
BCIHP0420	3,000	12.80	17.00	12.00	4.30	4.60	2.20	8.00	5.50	0.30
BCIHP0420TB	3,000	12.80	17.00	12.00	4.30	4.60	2.20	8.00	5.50	0.30
BCIHP0430	2,000	12.80	17.00	12.00	4.30	4.60	3.20	8.00	5.50	0.30

(2) Tearing Off Force

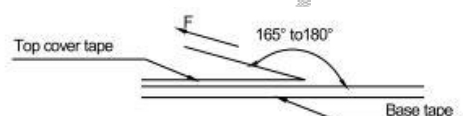

Room Temp. (°C)	Room Humidity (%)	Room atm (hPa)	Tearing Speed mm/min
5~35	45~85	860~1060	300

The force tearing off cover 10 to 130 grams (0.1N to 1.3N) in the arrow direction under the following conditions.

● Storage conditions/Note things

(1) Storage temperature and humidity conditions :

1. Product packing with Carrier tape: +5°C~+40°C and less than 60% RH.
2. Product alone: -20°C~+60°C and less than 60% RH.

(2) Products should be used within 6 months.

(3) The packaging material should be kept where no chlorine or sulfur exists in the air.

(4) Do not touch the electrodes (soldering terminals) with fingers as this may lead to deterioration of solder ability.

(5) The use of tweezers or vacuum pick-ups is strongly recommended for individual components.

(6) Bulk handling should ensure that abrasion and mechanical shock are minimized.

Powder Molding Type

BCIHP0412/18/20/30 Series

- Inside and Outside package for standard

ITEM			
Packing method & Dimensions			Box Size
			<p>W=345mm D=345mm H=185mm</p>
ITEM	Packing Quantity	Reel Quantity	Total Quantity
BCIHP0412	4,000 Pcs/Reel (0.76Kg(Ref))	8 Reel/Box	32,000 Pcs/Box (6.80Kg(Ref))
BCIHP0418	3,000 Pcs/Reel (0.80Kg(Ref))	8 Reel/Box	24,000 Pcs/Box (7.20Kg(Ref))
BCIHP0420	3,000 Pcs/Reel (0.80Kg(Ref))	8 Reel/Box	24,000 Pcs/Box (7.20Kg(Ref))
BCIHP0420TB	3,000 Pcs/Reel (0.80Kg(Ref))	8 Reel/Box	24,000 Pcs/Box (7.20Kg(Ref))
BCIHP0430	2,000 Pcs/Reel (0.85Kg(Ref))	8 Reel/Box	16,000 Pcs/Box (7.60Kg(Ref))

Powder Molding Type

BCIHP0412/18/20/30 Series

● General Characteristics

Operation Temperature -40°C to +125°C (Includes temperature when the coil is heated)
External Appearance On visual inspection, the coil has no external defects.

● Electrical Performance Test

Inductance	Refer to standard electrical characteristics list.
DCR	
Saturation Current(Isat)	BCIHP0412/18/20/30-Series $\Delta L \leq 20\%$ typical. BCIHP0410/0420TB-Series $\Delta L \leq 30\%$ typical.
Heat Rated Current(Irms)	Approximately $\Delta T \leq 40^\circ\text{C}$.

● Reliability Test

Solder Ability Test	<ol style="list-style-type: none"> More than 90% of terminal electrode should be covered with solder. <ul style="list-style-type: none"> After fluxing, component shall be dipped in a melted. Solder: bath at $245^\circ\text{C} \pm 5^\circ\text{C}$ for 5 ± 0.5 seconds. 	<p style="text-align: center;">Solder Ability Test</p>
Heat resistance of Reflow Soldering Test	<ol style="list-style-type: none"> Components should have not evidence of electrical and mechanical damage. Inductance: within $\pm 10\%$ of initial value. <ul style="list-style-type: none"> Preheat: $150 \pm 5^\circ\text{C}$ 60seconds. Solder temperature: $255 \pm 5^\circ\text{C} / -0^\circ\text{C}$. Flux: rosin. Dip time: 10 ± 0.5seconds. 	
Adhesion strength Test	<ol style="list-style-type: none"> No apparent damage <ul style="list-style-type: none"> Product is mounted on PCB. Thereafter R340 pressure fixture is used to apply pressure to product from backside of the board at a rate of approx. 1mm/sec. until bending width becomes 1mm and keep it for 5sec. 	<p style="text-align: center;">Pressing device Board/基板: 40 × 100mm Thickness/厚度: 1.2mm</p>
Welding strength Test	<ol style="list-style-type: none"> No separation or indication of electrode. <ul style="list-style-type: none"> A static load using a R5.0 pressing tool shall be applied to the body of the specimen in the direction of the arrow and shall be hold for 3 ± 1 sec. 	<p style="text-align: center;">5N 样品 Specimen</p>
Insulating Resistance	Over 100MΩ at 100V D.C. between coil and core.	
Dielectric Strength	No dielectric breakdown at 30V D.C. for 1 minute between coil and core.	
Vibration Test	Inductance deviation within +10% after vibration for 1 hour. In each of three orientations at Sweep vibration (10~55~10HZ) with 1.5mmP-P amplitudes.	<ol style="list-style-type: none"> No separation or indication of electrode. $\Delta L/L \leq 15\%$
Drop Test	Inductance deviation within +10% after being dropped once with 981m/s ² (100G) shock Attitude upon a rubber block method shock testing machine, in three different orientations.	

Powder Molding Type

BCIHP0412/18/20/30 Series

● Reliability Test

Item	Required Characteristics	Test Method/Condition
High Temperature Storage Test	<ol style="list-style-type: none"> No case deformation or change in appearance $\Delta L/L \leq 15\%$ $\Delta Q/Q \leq 30\%$ $\Delta DCR/DCR \leq 15\%$ <ul style="list-style-type: none"> Temperature: $125^{\circ}\text{C} \pm 3^{\circ}\text{C}$ Time: 96 ± 2 hours. Tested not less than 1 hour, nor more than 2 hours at room. 	
Low Temperature Storage Test	<ol style="list-style-type: none"> No case deformation or change in appearance $\Delta L/L \leq 15\%$ $\Delta Q/Q \leq 30\%$ $\Delta DCR/DCR \leq 15\%$ <ul style="list-style-type: none"> Temperature: $-40^{\circ}\text{C} \pm 3^{\circ}\text{C}$ Time: 96 ± 2 hours. Tested not less than 1 hour, nor more than 2 hours at room. 	
High Temperature Humidity Test	<ol style="list-style-type: none"> No case deformation or change in appearance $\Delta L/L \leq 15\%$ $\Delta Q/Q \leq 30\%$ $\Delta DCR/DCR \leq 15\%$ <ul style="list-style-type: none"> Temperature: $85^{\circ}\text{C} \pm 3^{\circ}\text{C}$. Humidity: $85 \pm 5\% \text{RH}$ Test Time: 96 ± 2 hours Tested not less than 1 hour. Nor more than 2 hours at room temperature. 	
Thermal Shock Storage Test	<ol style="list-style-type: none"> No case deformation or change in appearance $\Delta L/L \leq 15\%$ $\Delta Q/Q \leq 30\%$ $\Delta DCR/DCR \leq 15\%$ <ul style="list-style-type: none"> First -40°C for 30 Minutes, last 125°C for 30 Minutes as 1 cycle. Go through 20 cycles. 	

Powder Molding Type

BCIHP0412/18/20/30 Series

● Soldering re-flow

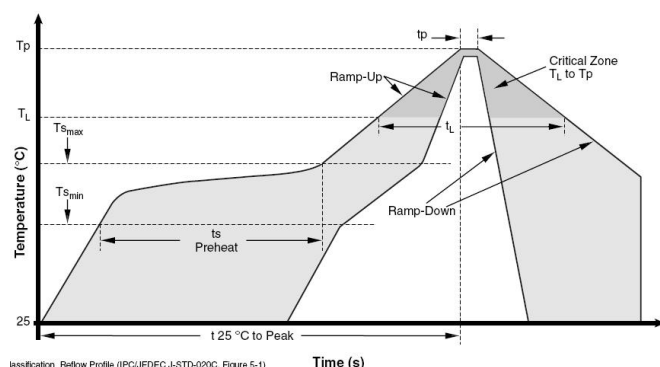
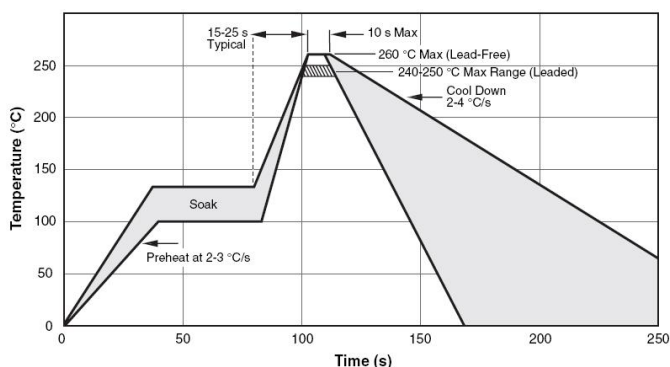

IPC/JEDEC J-STD-020C, Figure 5-1

Profile Feature	Sn-Pb Eutectic Assembly	Pb-Free Assembly
Average Ramp-Up Rate (Ts _{max} to T _p)	3 °C/second max.	3 °C/second max.
Preheat		
± Temperature Min (Ts _{min})	100 °C	150 °C
± Temperature Max (Ts _{max})	150 °C	200 °C
± Time (ts _{min} to ts _{max})	60-120 seconds	60-180 seconds
Time maintained above:		
± Temperature (T _L)	183 °C	217 °C
± Time (t _L)	60-150 seconds	60-150 seconds
Peak/Classification Temperature (T _p)	See Table 4.1	See Table 4.2
Time within 5 °C of actual Peak Temperature (t _p)	10-30 seconds	20-40 seconds
Ramp-Down Rate	6 °C/second max.	6 °C/second max.
Time 25 °C to Peak Temperature	6 minutes max.	8 minutes max.

Table 4. Classification Reflow Profiles (per IPC/JEDEC J-STD-020C, Table 5.2)

Note 1: All temperatures refer to topside of the package, measured on the package body surface.

Package Thickness	Volume mm ³ <350	Volume mm ³ ≥350
<2.5 mm	240 +0/-5 °C	225 +0/-5 °C
≥2.5 mm	225 +0/-5 °C	225 +0/-5 °C

Table 5. SnPb Eutectic Process – Package Peak Reflow Temperatures (per IPC/JEDEC J-STD-020C, Table 4.1)

Package Thickness	Volume mm ³ <350	Volume mm ³ 350-2000	Volume mm ³ >2000
<1.6 mm	260 + 0 °C *	260 + 0 °C *	260 + 0 °C *
1.6 mm - 2.5 mm	260 + 0 °C *	250 + 0 °C *	245 + 0 °C *
≥2.5 mm	250 + 0 °C *	245 + 0 °C *	245 + 0 °C *

* Tolerance: Process compatibility is up to and including the stated classification temperature (this means Peak reflow temperature + 0 °C. For example 260 °C + 0 °C) at the rated MSL level.

Table 6. Pb-free Process – Package Classification Reflow Temperatures (per IPC/JEDEC J-STD-020C, Table 4.2)

- Note 1: The profiling tolerance is + 0 °C, -X °C (based on machine variation capability) whatever is required to control the profile process but at no time will it exceed -5 °C. Process compatibility at the peak reflow profile temperatures as defined in Table 4.2.
- Note 2: Package volume excludes external terminals (balls, bumps, lands, leads) and/or nonintegral heat sinks.
- Note 3: The maximum component temperature reached during reflow depends on package thickness and volume. The use of convection reflow processes reduces the thermal gradients between packages. However, thermal gradients due to differences in thermal mass of SMD packages may still exist.
- Note 4: Components intended for use in a “lead-free” assembly process shall be evaluated using the “lead-free” classification temperatures and profiles defined in Tables 4.1, 4.2 and 5.2 whether or not lead free.

Powder Molding Type

BCIHP0412/18/20/30 Series

● Modify records

Numbering	Date	Modify content
[1]	2015/4/29	BCIHP0412-47NN Irms: 12A >13A.
[2]	2015/4/29	BCIHP0412-R10N DCR: 10.2mΩ >6.0mΩ. Irms: 10A >11.5A. Isat: 15A >25A.
[3]	2015/4/29	BCIHP0412-R20N Isat: 10A >20A.
[4]	2015/4/29	BCIHP0412-R22N Isat: 12A >20A.
[5]	2015/4/29	BCIHP0412-R47N DCR: 26mΩ >22mΩ. Irms: 6A >5A. Isat: 7A >13A.
[6]	2015/4/29	BCIHP0412-R68N DCR: 39mΩ >31.4mΩ. Irms: 3.3A >4.9A. Isat: 9A >9.3A.
[7]	2015/4/29	BCIHP0412-1R0N DCR: 55.5mΩ >52.5mΩ. Irms: 4.5A >4A.
[8]	2015/5/9	BCIHP0410-100M DCR: 550mΩ >800mΩ.
[9]	2015/5/9	BCIHP0412-100M Irms: 0.90A >1.20A. Isat: 1.00A >1.50A.
[10]	2015/5/9	BCIHP0412-R68N Isat: 7.0A >9.3A.
[11]	2015/8/21	BCIHP0420-R10N Isat: 22A >35A.
[12]	2015/8/21	BCIHP0420-R10N Irms: 12A >11A.
[12]	2015/8/21	BCIHP0420-R47M Irms: 7A >5.6A. Isat: 8A >11.50A.
[12]	2015/8/21	BCIHP0420-1R0N DCR: 42mΩ >37mΩ. Irms: 4A >3.75A. Isat: 5.7A >8.5A.
[12]	2015/8/21	BCIHP0420-2R2M Isat: 3A >6A.
[13]	2015/10/28	BCIHP0420TB-2R2M Irms: 3.0A >3.25A
[14]	2015/11/16	Added BCIHP0412-1R5M.
[15]	2015/11/16	Added BCIHP0420-R22M. BCIHP0420-R20M
[16]	2015/11/16	BCIHP0420-100M Isat: 1.8A >2.3A.
[17]	2015/11/16	Added BCIHP0420-220M'BCIHP0420TB-4R7M'BCIHP0420TB-5R6M'BCIHP0420TB-6R8M
[18]	2018/6/8	删除未量产过机种，已量产机种实际参数为准！