

General Description

The AOZ1282CI is a high efficiency, simple to use, 1.2A buck regulator flexible enough to be optimized for a variety of applications. The AOZ1282CI works from a 4.5V to 36V input voltage range, and provides up to 1.2A of continuous output current. The output voltage is adjustable down to 0.8V. The fixed switching frequency of 450kHz PWM operation reduces inductor size.

Features

- 4.5V to 36V operating input voltage range
- 420mΩ internal NMOS
- Up to 95% efficiency
- Internal compensation
- 1.2A continuous output current
- Fixed 450kHz PWM operation
- Internal soft start
- Output voltage adjustable down to 0.8V
- Cycle-by-cycle current limit
- Short-circuit protection
- Thermal shutdown
- Small size SOT23-6L

Applications

- Point of load DC/DC conversion
- Set top boxes and cable modems
- DVD drives and HDDs
- LCD Monitors & TVs
- Telecom/Networking/Datacom equipment



Typical Application

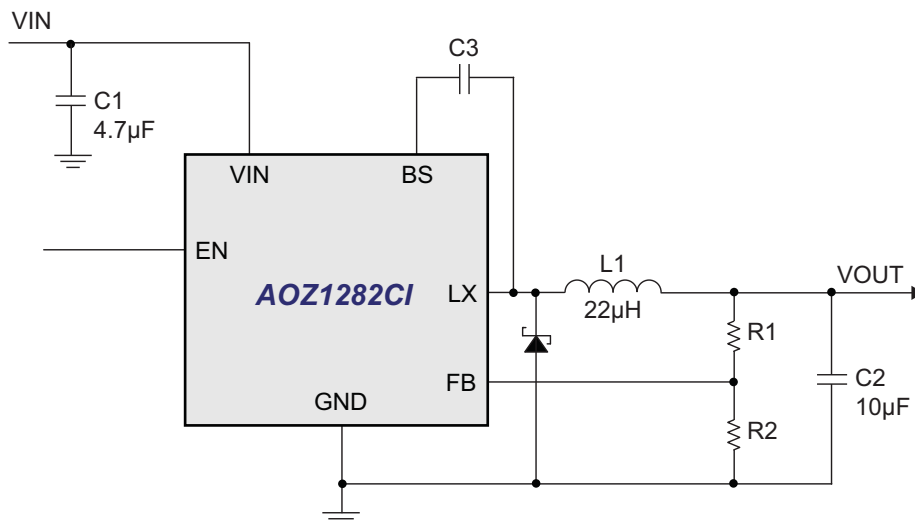

Figure 1. 1.2A Buck Regulator

Ordering Information

Part Number	Ambient Temperature Range	Package	Environmental
AOZ1282CI	-40 °C to +85 °C	SOT23-6L	Green Product



AOS Green Products use reduced levels of Halogens, and are also RoHS compliant. Please visit www.aosmd.com/media/AOSGreenPolicy.pdf for additional information.

Pin Configuration

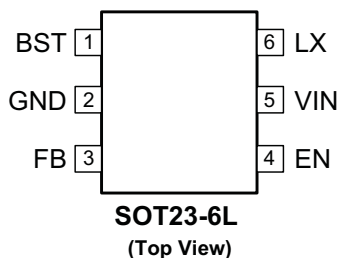

Pin Description

Pin Number	Pin Name	Pin Function
1	BST	Bootstrap Voltage Input. High side driver supply. Connected to 100nF capacitor between BST and LX.
2	GND	Ground.
3	FB	Feedback Input. It is regulated to 0.8V. The FB pin is used to determine the PWM output voltage via a resistor divider between the output and GND.
4	EN	Enable Pin. The enable pin is active high. Connect EN pin to VIN through current limiting resistor. Do not leave the EN pin floating.
5	VIN	Supply Voltage Input. Range from 4.5V to 36V. When VIN rises above the UVLO threshold the device starts up.
6	LX	PWM Output. Connect to inductor.

Absolute Maximum Ratings

Exceeding the Absolute Maximum Ratings may damage the device.

Parameter	Rating
Supply Voltage (V_{IN})	40V
LX to GND	-0.7V to $V_{VIN} + 0.3V$
EN to GND	-0.3V to 40V
FB to GND	-0.3V to 6V
BST to GND	$V_{LX} + 6V$
Junction Temperature (T_J)	+150°C
Storage Temperature (T_S)	-65°C to +150°C
ESD Rating ⁽¹⁾	2kV

Note:

1. Devices are inherently ESD sensitive, handling precautions are required. Human body model rating: 1.5k Ω in series with 100pF.

Recommended Operating Conditions

The device is not guaranteed to operate beyond the Recommended Operating Conditions.

Parameter	Rating
Supply Voltage (V_{IN})	4.5V to 36V
Output Voltage (V_{OUT})	0.8V to V_{VIN}
Ambient Temperature (T_A)	-40°C to +85°C
Package Thermal Resistance (Θ_{JA}) SOT23-6L	220°C/W

Electrical Characteristics

$T_A = 25^\circ\text{C}$, $V_{IN} = V_{EN} = 12V$, unless otherwise specified. Specifications in **BOLD** indicate a temperature range of -40°C to +85°C. These specifications are guaranteed by design.

Symbol	Parameter	Conditions	Min.	Typ.	Max.	Units
V_{IN}	Supply Voltage		4.5		36	V
V_{UVLO}	Input Under-Voltage Lockout Threshold	V_{IN} rising V_{IN} falling	2.3		2.9	V V
	UVLO Hysteresis			260		mV
I_{IN}	Supply Current (Quiescent)	$I_{OUT} = 0$, $V_{FB} = 1V$, $V_{EN} > 1.2V$		1	1.5	mA
I_{OFF}	Shutdown Supply Current	$V_{EN} = 0V$			8	μA
V_{FB}	Feedback Voltage	$T_A = 25^\circ\text{C}$	784	800	816	mV
V_{FB_LOAD}	Load Regulation	120mA < Load < 1.08A		0.5		%
V_{FB_LINE}	Line Regulation	Load = 600mA		0.03		%/V
I_{FB}	Feedback Voltage Input Current	$V_{FB} = 800\text{mV}$		500		nA
ENABLE						
V_{EN_OFF} V_{EN_ON}	EN Input Threshold	Off threshold On threshold	1.2		0.4	V V
V_{EN_HYS}	EN Input Hysteresis			200		mV
I_{EN}	Enable Input Current				3	μA
MODULATOR						
f_O	Frequency		360	450	540	kHz
D_{MAX}	Maximum Duty Cycle			87		%
T_{ON_MIN}	Minimum On Time			150		ns
I_{LIM}	Current Limit		1.5	1.9		A
	Over-Temperature Shutdown Limit	T_J rising T_J falling		150 110		°C °C
T_{SS}	Soft Start Interval			1.5		ms
POWER STATE OUTPUT						
$I_{LEAKAGE}$	NMOS Leakage	$V_{EN} = 0V$, $V_{LX} = 0V$			10	μA
$R_{DS(ON)}$	NMOS On-Resistance	$V_{IN} = 12V$		420		m Ω

Block Diagram

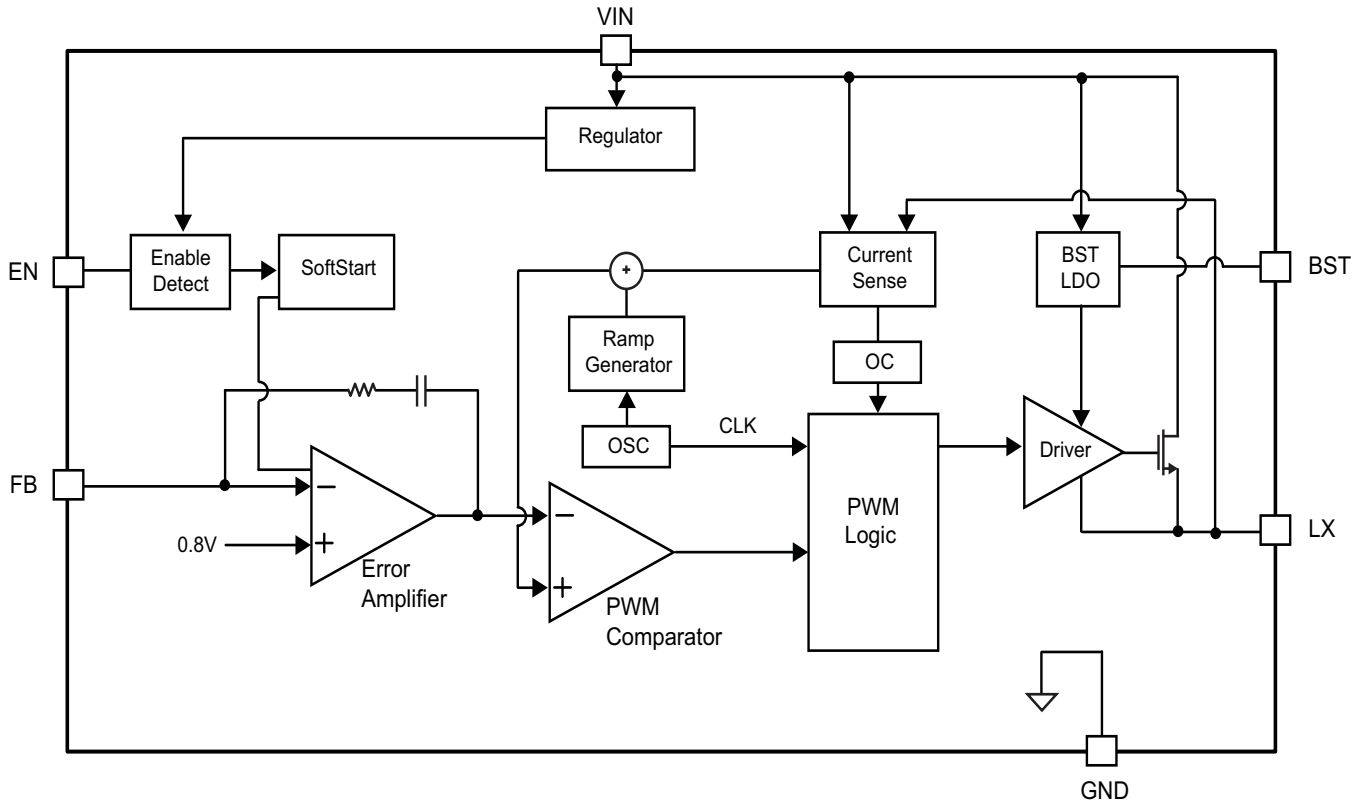

Typical Performance Characteristics

Circuit of Figure 1. $T_A = 25^\circ\text{C}$, $V_{IN} = V_{EN} = 12\text{V}$, $V_{OUT} = 3.3\text{V}$, unless otherwise specified.

Light Load Operation

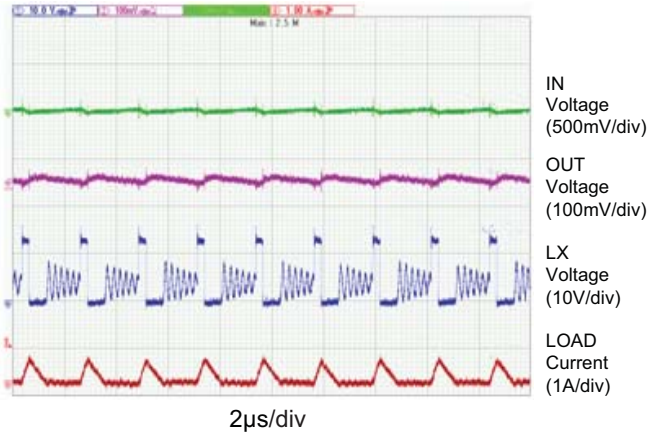

Full Load Operation

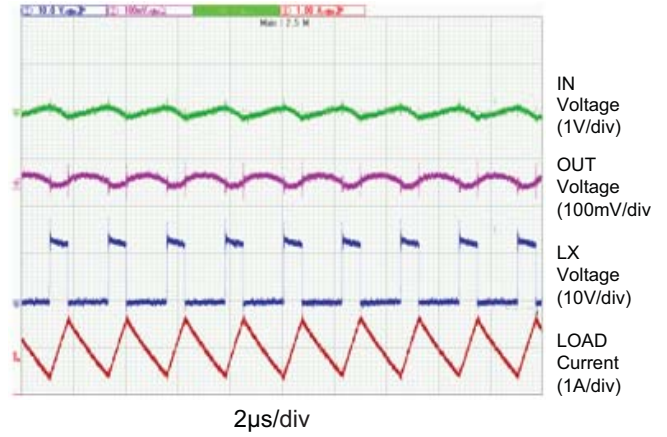

Start Up to Full Load



Load Transient

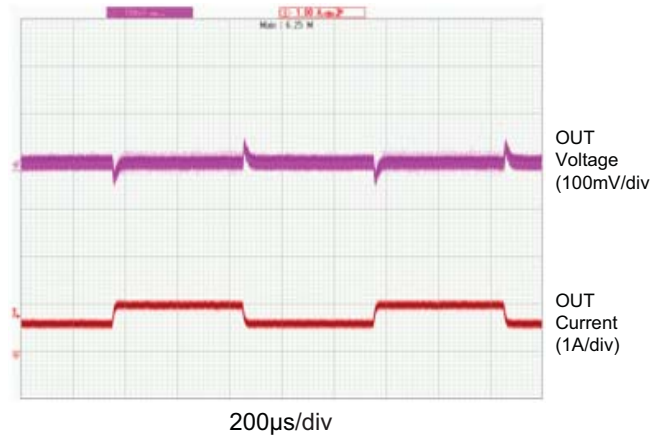

Short Circuit Protection

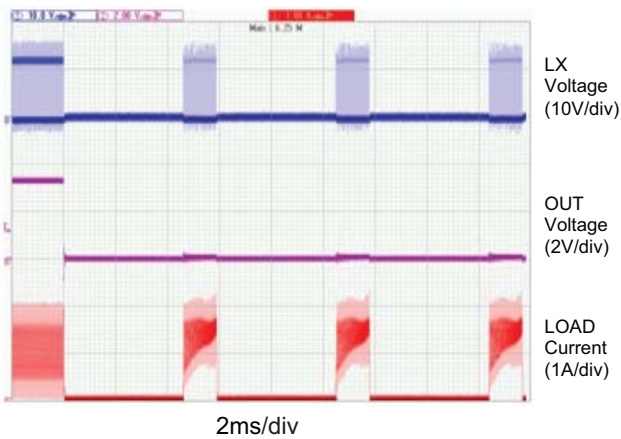

Short Circuit Recovery

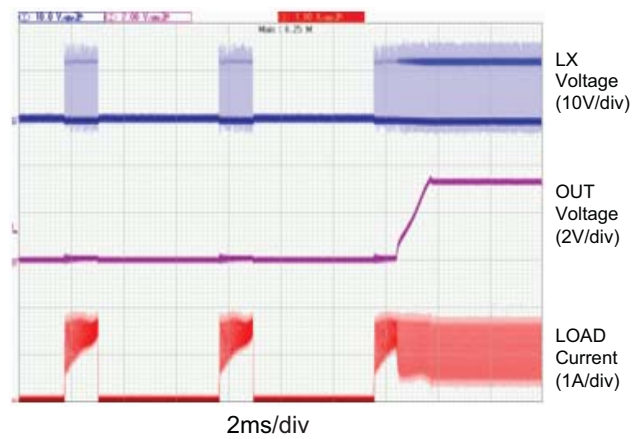

Typical Performance Characteristics (continued)

Efficiency (Vo=5V)
vs. Load Current

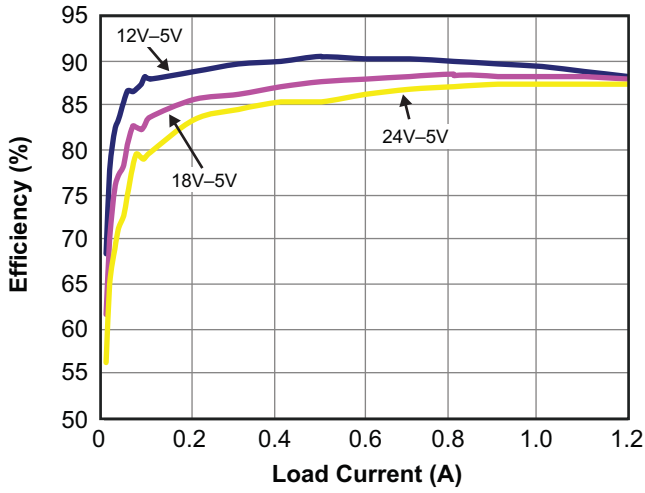

Efficiency (Vo=3.3V)
vs. Load Current

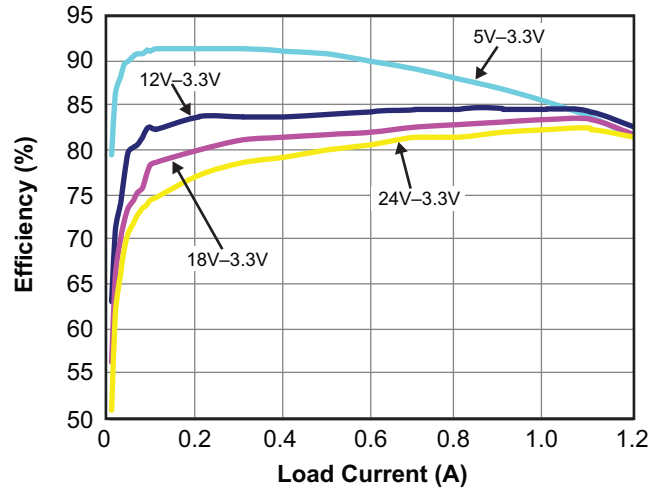

Current Limit vs. Input Voltage
(Vo=3.3V)

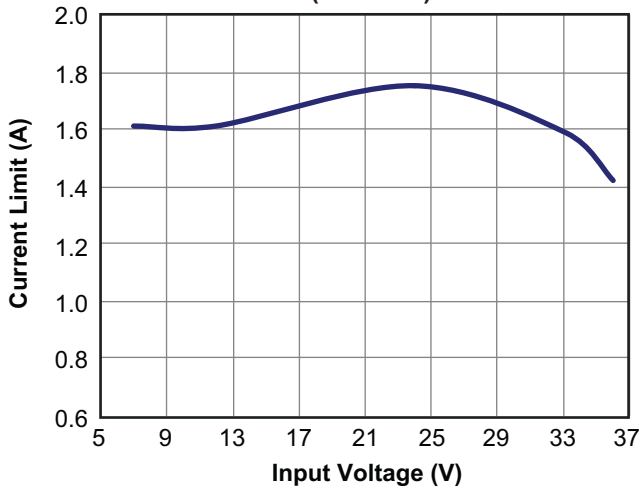

Detailed Description

The AOZ1282CI is a current-mode step down regulator with integrated high side NMOS switch. It operates from a 4.5V to 36V input voltage range and supplies up to 1.2A of load current. Features include enable control, under voltage lock-out, internal soft-start, output over-voltage protection, over-current protection and thermal shut down.

The AOZ1282CI is available in SOT23-6L package.

Enable and Soft Start

The AOZ1282CI has internal soft start feature to limit in-rush current and ensure the output voltage ramps up smoothly to regulation voltage. A soft start process begins when the input voltage rises to the voltage higher than UVLO and voltage on EN pin is HIGH. In soft start process, the output voltage is ramped to regulation voltage in typically 400µs. The 400µs soft start time is set internally.

The EN pin of the AOZ1282CI is active high. Connect the EN pin to VIN if enable function is not used. Pull it to ground will disable the AOZ1282CI. Do not leave it open. The voltage on EN pin must be above 1.2 V to enable the AOZ1282CI. When voltage on EN pin falls below 0.4V, the AOZ1282CI is disabled.

Steady-State Operation

Under steady-state conditions, the converter operates in fixed frequency and Continuous-Conduction Mode (CCM).

The AOZ1282CI integrates an internal NMOS as the high-side switch. Inductor current is sensed by amplifying the voltage drop across the drain to source of the high side power MOSFET. Output voltage is divided down by the external voltage divider at the FB pin. The difference of the FB pin voltage and reference is amplified by the internal transconductance error amplifier. The error voltage is compared against the current signal, which is sum of inductor current signal and ramp compensation signal, at PWM comparator input. If the current signal is less than the error voltage, the internal high-side switch is on. The inductor current flows from the input through the inductor to the output. When the current signal exceeds the error voltage, the high-side switch is off. The inductor current is freewheeling through the external Schottky diode to output.

Switching Frequency

The AOZ1282CI switching frequency is fixed and set by an internal oscillator. The switching frequency is set internally 450kHz.

Output Voltage Programming

Output voltage can be set by feeding back the output to the FB pin with a resistor divider network. In the application circuit shown in Figure 1. The resistor divider network includes R1 and R2. Usually, a design is started by picking a fixed R2 value and calculating the required R1 with equation below.

$$V_O = 0.8 \times \left(1 + \frac{R_1}{R_2} \right)$$

Some standard values of R1 and R2 for the most commonly used output voltage values are listed in Table 1.

Vo (V)	R1 (kΩ)	R2 (kΩ)
1.8	80.6	64.2
2.5	49.9	23.4
3.3	49.9	15.8
5.0	49.9	9.53

Table 1.

The combination of R1 and R2 should be large enough to avoid drawing excessive current from the output, which will cause power loss.

Protection Features

The AOZ1282CI has multiple protection features to prevent system circuit damage under abnormal conditions.

Over Current Protection (OCP)

The sensed inductor current signal is also used for over current protection.

The cycle by cycle current limit threshold is set normal value of 1.9A. When the load current reaches the current limit threshold, the cycle by cycle current limit circuit turns off the high side switch immediately to terminate the current duty cycle. The inductor current stop rising. The cycle by cycle current limit protection directly limits inductor peak current. The average inductor current is also limited due to the limitation on peak inductor current. When cycle by cycle current limit circuit is triggered, the output voltage drops as the duty cycle decreasing.

The AOZ1282CI has internal short circuit protection to protect itself from catastrophic failure under output short circuit conditions. The FB pin voltage is proportional to the output voltage. Whenever FB pin voltage is below 0.2V, the short circuit protection circuit is triggered. As a result, the converter is shut down and hiccups. The converter will start up via a soft start once the short circuit condition disappears. In short circuit protection mode, the inductor average current is greatly reduced.

Under Voltage Lock Out (UVLO)

An UVLO circuit monitors the input voltage. When the input voltage exceeds 2.9V, the converter starts operation. When input voltage falls below 2.3V, the converter will stop switching.

Thermal Protection

An internal temperature sensor monitors the junction temperature. It shuts down the internal control circuit and high side NMOS if the junction temperature exceeds 150°C. The regulator will restart automatically under the control of soft-start circuit when the junction temperature decreases to 110°C.

Application Information

The basic AOZ1282CI application circuit is shown in Figure 1. Component selection is explained below.

Input Capacitor

The input capacitor must be connected to the VIN pin and PGND pin of the AOZ1282CI to maintain steady input voltage and filter out the pulsing input current. The voltage rating of input capacitor must be greater than maximum input voltage plus ripple voltage.

The input ripple voltage can be approximated by equation below:

$$\Delta V_{IN} = \frac{I_O}{f \times C_{IN}} \times \left(1 - \frac{V_O}{V_{IN}}\right) \times \frac{V_O}{V_{IN}}$$

Since the input current is discontinuous in a buck converter, the current stress on the input capacitor is another concern when selecting the capacitor. For a buck circuit, the RMS value of input capacitor current can be calculated by:

$$I_{CIN_RMS} = I_O \times \sqrt{\frac{V_O}{V_{IN}} \left(1 - \frac{V_O}{V_{IN}}\right)}$$

if we let m equal the conversion ratio:

$$\frac{V_O}{V_{IN}} = m$$

The relationship between the input capacitor RMS current and voltage conversion ratio is calculated and shown in Figure 2. It can be seen that when V_O is half of V_{IN} , C_{IN} is under the worst current stress. The worst current stress on C_{IN} is $0.5 \times I_O$.

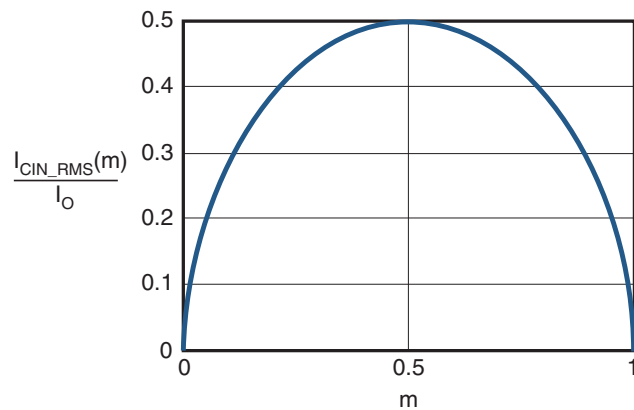

Figure 2. I_{CIN} vs. Voltage Conversion Ratio

For reliable operation and best performance, the input capacitors must have current rating higher than I_{CIN_RMS} at worst operating conditions. Ceramic capacitors are preferred for input capacitors because of their low ESR and high ripple current rating. Depending on the application circuits, other low ESR tantalum capacitor or aluminum electrolytic capacitor may also be used. When selecting ceramic capacitors, X5R or X7R type dielectric ceramic capacitors are preferred for their better temperature and voltage characteristics. Note that the ripple current rating from capacitor manufactures is based on certain amount of life time. Further de-rating may be necessary for practical design requirement.

Inductor

The inductor is used to supply constant current to output when it is driven by a switching voltage. For given input and output voltage, inductance and switching frequency together decide the inductor ripple current, which is:

$$\Delta I_L = \frac{V_O}{f \times L} \times \left(1 - \frac{V_O}{V_{IN}}\right)$$

The peak inductor current is:

$$I_{Lpeak} = I_O + \frac{\Delta I_L}{2}$$

High inductance gives low inductor ripple current but requires larger size inductor to avoid saturation. Low ripple current reduces inductor core losses. It also reduces RMS current through inductor and switches, which results in less conduction loss.

When selecting the inductor, make sure it is able to handle the peak current without saturation even at the highest operating temperature.

The inductor takes the highest current in a buck circuit. The conduction loss on inductor needs to be checked for thermal and efficiency requirements.

Surface mount inductors in different shape and styles are available from Coilcraft, Elytone and Murata. Shielded inductors are small and radiate less EMI noise. But they cost more than unshielded inductors. The choice depends on EMI requirement, price and size.

Output Capacitor

The output capacitor is selected based on the DC output voltage rating, output ripple voltage specification and ripple current rating.

The selected output capacitor must have a higher rated voltage specification than the maximum desired output voltage including ripple. De-rating needs to be considered for long term reliability.

Output ripple voltage specification is another important factor for selecting the output capacitor. In a buck converter circuit, output ripple voltage is determined by inductor value, switching frequency, output capacitor value and ESR. It can be calculated by the equation below:

$$\Delta V_O = \Delta I_L \times \left(ESR_{CO} + \frac{1}{8 \times f \times C_O} \right)$$

where,

C_O is output capacitor value, and

ESR_{CO} is the equivalent series resistance of the output capacitor.

When low ESR ceramic capacitor is used as output capacitor, the impedance of the capacitor at the switching frequency dominates. Output ripple is mainly caused by capacitor value and inductor ripple current. The output ripple voltage calculation can be simplified to:

$$\Delta V_O = \Delta I_L \times \left(\frac{1}{8 \times f \times C_O} \right)$$

If the impedance of ESR at switching frequency dominates, the output ripple voltage is mainly decided by capacitor ESR and inductor ripple current. The output ripple voltage calculation can be further simplified to:

$$\Delta V_O = \Delta I_L \times ESR_{CO}$$

For lower output ripple voltage across the entire operating temperature range, X5R or X7R dielectric type of ceramic, or other low ESR tantalum capacitor or aluminum electrolytic capacitor may also be used as output capacitors.

In a buck converter, output capacitor current is continuous. The RMS current of output capacitor is decided by the peak to peak inductor ripple current. It can be calculated by:

$$I_{CO_RMS} = \frac{\Delta I_L}{\sqrt{12}}$$

Usually, the ripple current rating of the output capacitor is a smaller issue because of the low current stress. When the buck inductor is selected to be very small and inductor ripple current is high, output capacitor could be overstressed.

Schottky Diode Selection

The external freewheeling diode supplies the current to the inductor when the high side NMOS switch is off. To reduce the losses due to the forward voltage drop and recovery of diode, Schottky diode is recommended to use. The maximum reverse voltage rating of the chosen Schottky diode should be greater than the maximum input voltage, and the current rating should be greater than the maximum load current.

Thermal Management and Layout Consideration

In the AOZ1282CI buck regulator circuit, high pulsing current flows through two circuit loops. The first loop starts from the input capacitors, to the VIN pin, to the LX pins, to the filter inductor, to the output capacitor and load, and then return to the input capacitor through ground. Current flows in the first loop when the high side switch is on. The second loop starts from inductor, to the output capacitors and load, to the anode of Schottky diode, to the cathode of Schottky diode. Current flows in the second loop when the low side diode is on.

In PCB layout, minimizing the two loops area reduces the noise of this circuit and improves efficiency. A ground plane is strongly recommended to connect input capacitor, output capacitor, and PGND pin of the AOZ1282CI.

In the AOZ1282CI buck regulator circuit, the major power dissipating components are the AOZ1282CI, the Schottky diode and output inductor. The total power dissipation of converter circuit can be measured by input power minus output power.

$$P_{total_loss} = (V_{IN} \times I_{IN}) - (V_O \times I_{IN})$$

The power dissipation in Schottky can be approximated as:

$$P_{diode_loss} = I_O \times (1 - D) \times V_{FW_Schottky}$$

where,

$V_{FW_Schottky}$ is the Schottky diode forward voltage drop.

The power dissipation of inductor can be approximately calculated by output current and DCR of inductor.

$$P_{inductor_loss} = I_O^2 \times R_{inductor} \times 1.1$$

The actual junction temperature can be calculated with power dissipation in the AOZ1282CI and thermal impedance from junction to ambient.

$$T_{junction} = \frac{(P_{total_loss} - P_{diode_loss} - P_{inductor_loss})}{\theta_{JA} + T_{ambient}}$$

The maximum junction temperature of AOZ1282CI is 150°C, which limits the maximum load current capability.

The thermal performance of the AOZ1282CI is strongly affected by the PCB layout. Extra care should be taken by users during design process to ensure that the IC will operate under the recommended environmental conditions.

Several layout tips are listed below for the best electric and thermal performance.

1. The input capacitor should be connected as close as possible to the VIN pin and the GND pin.
2. The inductor should be placed as close as possible to the LX pin and the output capacitor.
3. Keep the connection of the schottky diode between the LX pin and the GND pin as short and wide as possible.
4. Place the feedback resistors and compensation components as close to the chip as possible.
5. Keep sensitive signal traces away from the LX pin.
6. Pour a maximized copper area to the VIN pin, the LX pin and especially the GND pin to help thermal dissipation.
7. Pour a copper plane on all unused board area and connect the plane to stable DC nodes, like VIN, GND or VOUT.

Package Dimensions, SOT23-6

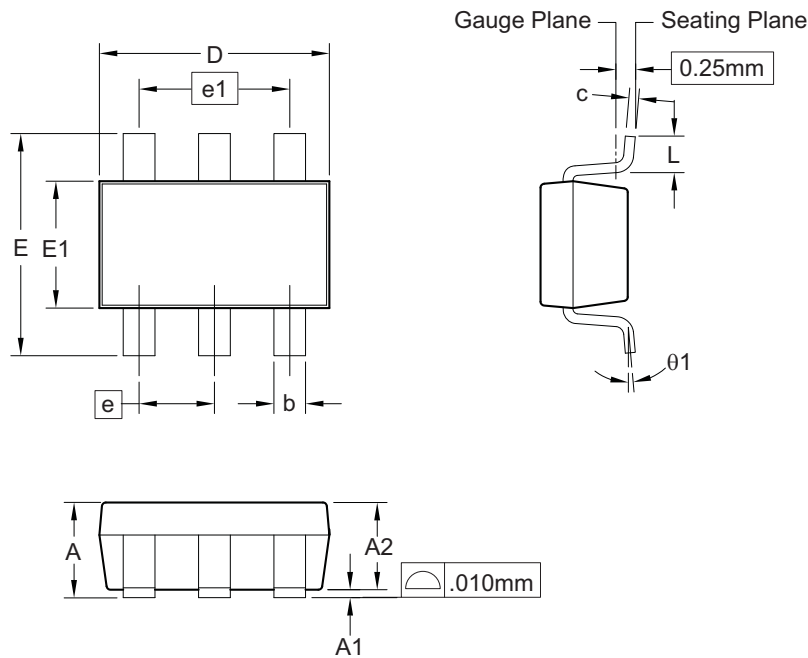

RECOMMENDED LAND PATTERN

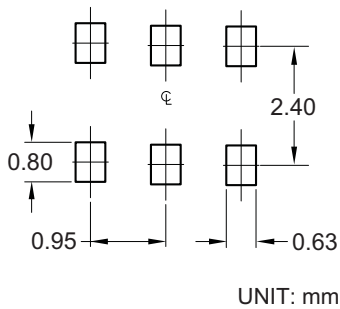

Dimensions in millimeters

Symbols	Min.	Nom.	Max.
A	0.80	—	1.25
A1	0.00	—	0.15
A2	0.70	1.10	1.20
b	0.30	0.40	0.50
c	0.08	0.13	0.20
D	2.70	2.90	3.10
E	2.50	2.80	3.10
E1	1.50	1.60	1.70
e	0.95 BSC		
e1	1.90 BSC		
L	0.30	—	0.60
θ1	0°	—	8°

Dimensions in inches

Symbols	Min.	Nom.	Max.
A	0.031	—	0.049
A1	0.000	—	0.006
A2	0.028	0.043	0.047
b	0.012	0.016	0.020
c	0.003	0.005	0.008
D	0.106	0.114	0.122
E	0.098	0.110	0.122
E1	0.059	0.063	0.067
e	0.037 BSC		
e1	0.075 BSC		
L	0.012	—	0.024
θ1	0°	—	8°

Notes:

1. Package body sizes exclude mold flash and gate burrs. Mold flash at the non-lead sides should be less than 5 mils each.
2. Dimension "L" is measured in gauge plane.
3. Tolerance ±0.100 mm (4 mil) unless otherwise specified.
4. Followed from JEDEC MO-178C & MO-193C.
5. Controlling dimension is millimeter. Converted inch dimensions are not necessarily exact.

Tape and Reel Dimensions, SOT23-6

Tape

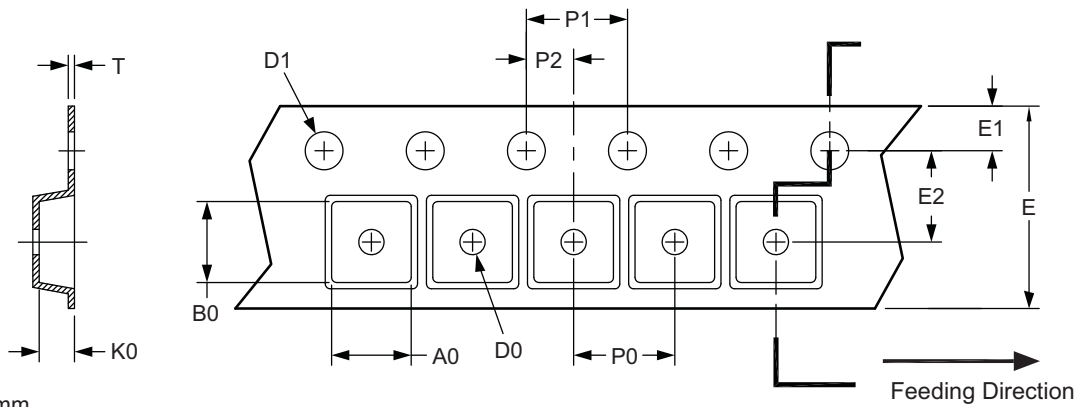

Unit: mm

Package	A0	B0	K0	D0	D1	E	E1	E2	P0	P1	P2	T
SOT-23	3.15 ±0.10	3.27 ±0.10	1.34 ±0.10	1.10 ±0.01	1.50 ±0.10	8.00 ±0.20	1.75 ±0.10	3.50 ±0.05	4.00 ±0.10	4.00 ±0.10	2.00 ±0.10	0.25 ±0.05

Reel

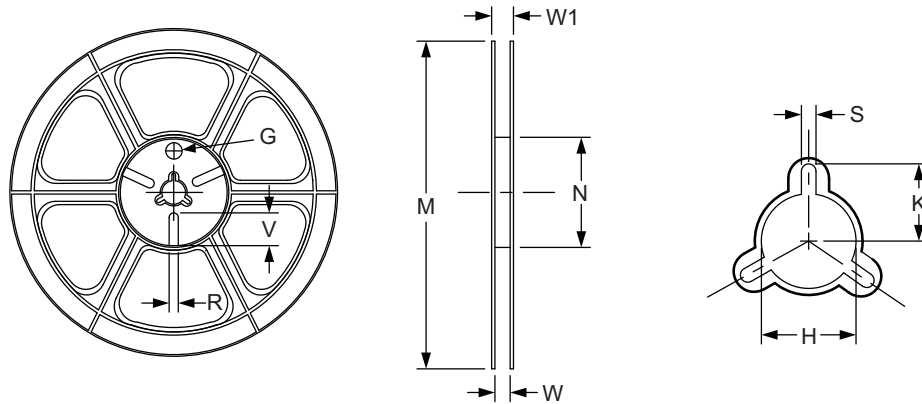

Unit: mm

Tape Size	Reel Size	M	N	W	W1	H	K	S	G	R	V
8 mm	ø180	ø180.00 ±0.50	ø60.50 Min.	9.00 ±0.30	11.40 ±1.0	ø13.00 +0.50 / -0.20	10.60	2.00 ±0.50	ø9.00	5.00	18.00

Leader/Trailer and Orientation

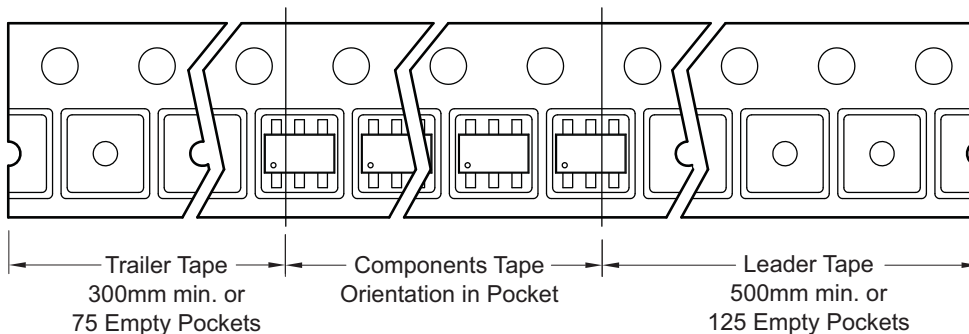

Part Marking

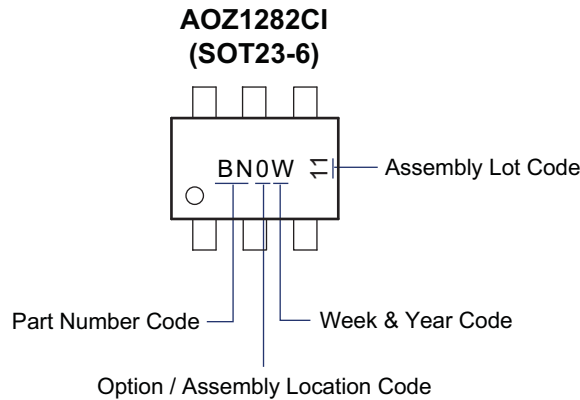

LEGAL DISCLAIMER

Alpha and Omega Semiconductor makes no representations or warranties with respect to the accuracy or completeness of the information provided herein and takes no liabilities for the consequences of use of such information or any product described herein. Alpha and Omega Semiconductor reserves the right to make changes to such information at any time without further notice. This document does not constitute the grant of any intellectual property rights or representation of non-infringement of any third party’s intellectual property rights.

LIFE SUPPORT POLICY

ALPHA AND OMEGA SEMICONDUCTOR PRODUCTS ARE NOT AUTHORIZED FOR USE AS CRITICAL COMPONENTS IN LIFE SUPPORT DEVICES OR SYSTEMS.

As used herein:

- | | |
|---|---|
| <p>1. Life support devices or systems are devices or systems which, (a) are intended for surgical implant into the body or (b) support or sustain life, and (c) whose failure to perform when properly used in accordance with instructions for use provided in the labeling, can be reasonably expected to result in a significant injury of the user.</p> | <p>2. A critical component in any component of a life support, device, or system whose failure to perform can be reasonably expected to cause the failure of the life support device or system, or to affect its safety or effectiveness.</p> |
|---|---|