

## Part Numbering System

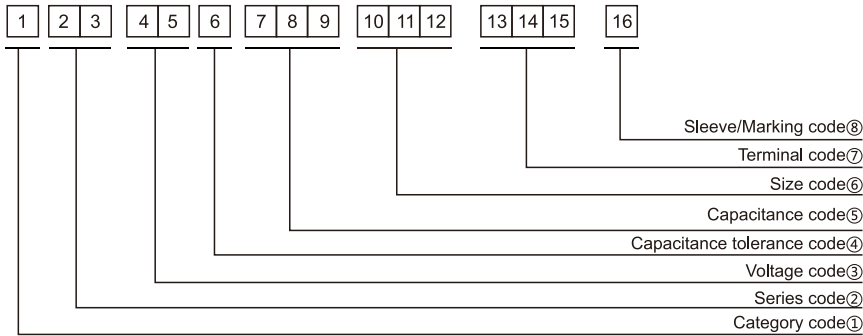

① Category code

Type	Code
	1
Electrolytic Capacitor	E
Conductive Polymer	S

② Series code

Series name	Code	
	2	3
WH	W	H
CD11GE	G	E
CD11GES	G	X
CD11GAS	G	W
CD11GHS	G	S
NR	N	R
PZ	P	Z

③ Voltage code

WV (V <sub>dc</sub> )	Code	
	4	5
2.5	0	E
3	0	D
4	0	G
6.3	0	J
6.8	0	C
7	0	Q
7.5	0	A
10	1	A
12	1	T
16	1	C
25	1	E
35	1	V
40	1	G
50	1	H
63	1	J
80	1	B
100	1	K
120	2	B
160	2	C
180	2	L
200	2	D
220	2	N
250	2	E
315	2	F
350	2	V
380	2	P
400	2	G
420	2	T
450	2	W
500	2	H
550	2	J
600	2	K

④ Capacitance tolerance code

Tol. (%)	Code
	6
-10~+10	K
-20~+20	M
-10~+30	Q
-10~+20	V
0~+20	A
-5~+20	C
-10~-20	B
-5~+5	D
0~+10	E
-5~-20	F
-15~+5	N

⑤ Capacitance code

Cap (μF)	Code		
	7	8	9
0.10	R	1	0
0.22	R	2	2
0.33	R	3	3
0.47	R	4	7
0.68	R	6	8
1	0	1	0
2.2	2	R	2
3.3	3	R	3
4.7	4	R	7
6.8	6	R	8
10	1	0	0
22	2	2	0
33	3	3	0
47	4	7	0
68	6	8	0
100	1	0	1
220	2	2	1
330	3	3	1
470	4	7	1
680	6	8	1
1000	1	0	2
2200	2	2	2
3300	3	3	2
4700	4	7	2
6800	6	8	2
10000	1	0	3
22000	2	2	3
33000	3	3	3
68000	6	8	3

⑥ Size code

ΦD (mm)	Code
10	
4	C
5	D
6.3	E
8	F
10	G
11	H
12	J
12.5	W
13	K
14	X
16	L
18	M
19	Z
20	N
22	O
25	P
30	Q
35	R
40	Y
51.6	S
64.3	T
76.9	U
91	V
100	A

L (mm)	Code	
	11	12
5	0	5
7	0	7
11	1	1
12	1	2
16	1	6
20	2	0
25	2	5
30	3	0
35	3	5
40	4	0
46	4	6
50	5	0
60	6	0
80	8	0
100	A	0
115	B	5
120	C	0
130	D	0
140	E	0
160	G	0
200	K	0
220	M	0
236	N	6
250	P	0

⑦ Terminal code

Specification	Code	Size	
	13	14	15
Bulk packing	O	-	-
Taping (SMD Type)	D	0	0
Φ4~8 Taping F=5.0mm	P	5	0
Φ10~12.5 Taping F=5.0mm	B	5	0
Lead Cut L=3.5mm	C	3	5
Lead Cut L=11.0mm	C	B	0
Lead Forming & Cut L=4.5mm	F	-	-
Kink & Cut L=4.5mm	J	-	-
Snap-in type Terminal 4.0mm in length	K	-	-
Three Terminals	T	-	-
Ring clip mounting standard design	A	0	0
Ring clip mounting special design	S	-	-

⑧ Sleeve/Marking code

Sleeve/Marking	Code
	16
PVC	C
PET	T
Dark blue	B
Bright red	R
Sky-blue	S
Light blue	T
Pink	Z
Black	H
Purple-blue	V
Red	O

Lead Forming  
Taping Specifications

Fig.1 code: X



Fig.2 code: B



Fig.3 code: B

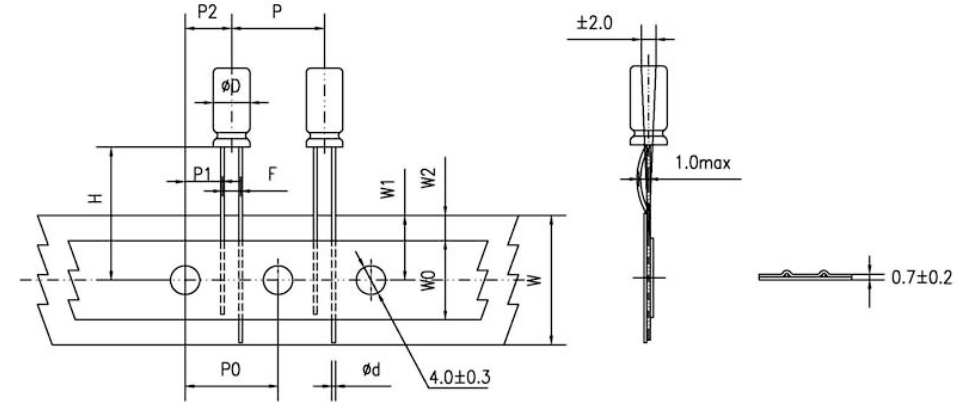

Fig.4 code: P



## Lead Forming

Specification Fig.1 & Fig.2 & Fig.3

Items	Symbol	Case size										Tolerance		
		4*5 4*7		5*5 5*7		5*11		6.3*5	6.3*7 6.3*9	6.3*11 6.3*12	8*5/7 8*9/11 8*11.5 8*12		8*16 8*20	10*9/12 10*12.5 10*13/16 10*20/25
Pin Code		X	B	X	B	X	B	B	B	B	B	B	B	
Lead wire diameter	Φd	0.45		0.45		0.5		0.45	0.5	0.5	0.45/0.5	0.6	0.6	±0.05
Pitch of body	P	12.7		12.7		12.7		12.7	12.7	12.7	12.7	12.7	12.7	±1.0
Feed hole pitch	P0	12.7		12.7		12.7		12.7	12.7	12.7	12.7	12.7	12.7	±0.2
Distance from hole center to lead	P1	5.1	5.6	5.1	5.35	5.1	5.35	5.1	5.1	5.1	4.6	4.6	3.85	±0.7
Distance from feed hole center to body center	P2	6.35		6.35		6.35		6.35	6.35	6.35	6.35	6.35	6.35	±1.0
Lead-to-lead distance	F	2.5	1.5	2.5	2.0	2.5	2.0	2.5	2.5	2.5	3.5	3.5	5.0	±0.5
Height of body from tape center	H	18.5		18.5		18.5		18.5	18.5	18.5	18.5	18.5	18.5	±0.75
Base tape width	W	18.0		18.0		18.0		18.0	18.0	18.0	18.0	18.0	18.0	±0.5
Adhesive tape width	W0	6.0		6.0		6.0		6.0	6.0	8.0	8.0	8.0	11.0	min
Hole position	W1	9.0		9.0		9.0		9.0	9.0	9.0	9.0	9.0	9.0	+0.75 -0.5
Hole down tape position	W2	3.0		3.0		3.0		3.0	3.0	3.0	3.0	3.0	3.0	max

Specification Fig.4

Items	Symbol	Case size									Tolerance
		4*5 4*7	5*5	5*7	5*11	6.3*5	6.3*7 6.3*9	6.3*11 6.3*12	8*5/7 8*9/11 8*11.5/12	8*16 8*20	
Pin Code		P	P	P	P	P	P	P	P	P	
Lead wire diameter	Φd	0.45	0.45	0.45	0.5	0.45	0.5	0.5	0.45/0.5	0.6	±0.05
Pitch of body	P	12.7	12.7	12.7	12.7	12.7	12.7	12.7	12.7	12.7	±1.0
Feed hole pitch	P0	12.7	12.7	12.7	12.7	12.7	12.7	12.7	12.7	12.7	±0.2
Distance from hole center to lead	P1	3.85	3.85	3.85	3.85	3.85	3.85	3.85	3.85	3.85	±0.7
Distance from feed hole center to body center	P2	6.35	6.35	6.35	6.35	6.35	6.35	6.35	6.35	6.35	±1.0
Lead-to-lead distance	F	1.5	2.0	2.0	2.0	2.5	2.5	2.5	3.5	3.5	±0.5
Lead to lead distance	F1	5.0	5.0	5.0	5.0	5.0	5.0	5.0	5.0	5.0	+0.8 -0.2
Height of body from tape center	H	18.5	18.5	18.5	18.5	18.5	18.5	18.5	18.5	18.5	±0.75
Lead wire clinch height	H0	16.0	16.0	16.0	16.0	16.0	16.0	16.0	16.0	16.0	±0.5
Base tape width	W	18.0	18.0	18.0	18.0	18.0	18.0	18.0	18.0	18.0	±0.5
Adhesive tape width	W0	6.0	6.0	6.0	6.0	6.0	6.0	8.0	8.0	8.0	min
Hole position	W1	9.0	9.0	9.0	9.0	9.0	9.0	9.0	9.0	9.0	+0.75 -0.5
Hole down tape position	W2	3.0	3.0	3.0	3.0	3.0	3.0	3.0	3.0	3.0	max

**Lead Forming**

Lead Forming & Cut

Code:C  
RANGE:  $\Phi 4\sim\Phi 18$

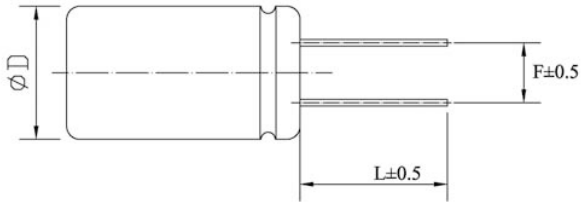

Code:F  
RANGE:  $\Phi 4\sim\Phi 8$

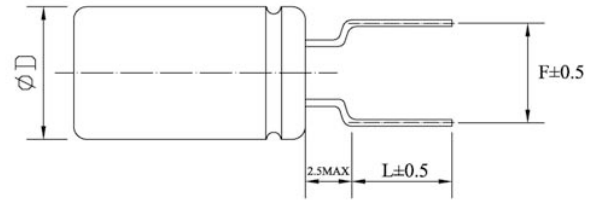

$\Phi D$	F	L	$\Phi D$	F	L
4	1.5	3.0~12.0	4	5.0	3.5, 4.5, 5.0, 7.0
5	2.0	3.0~12.0	5	5.0	3.5, 4.5, 5.0, 7.0
6.3	2.5	3.0~12.0	6.3	5.0	3.5, 4.5, 5.0, 7.0
8	3.5	3.0~12.0	8	5.0	3.5, 4.5, 5.0, 7.0
10	5.0	3.0~12.0	-	-	-
12.5	5.0	3.0~12.0	-	-	-
16	7.5	3.0~12.0	-	-	-
18	7.5	3.0~12.0	-	-	-

Code:J  
RANGE:  $\Phi 10\sim\Phi 18$



$\Phi D$	F	L
10	5.0	4.0, 4.5, 5.0
12.5	5.0	4.0, 4.5, 5.0
16	7.5	4.0, 4.5, 5.0
18	7.5	4.0, 4.5, 5.0

### Solering Recommendation

■ Flow Soldering(Radial Lead Type)

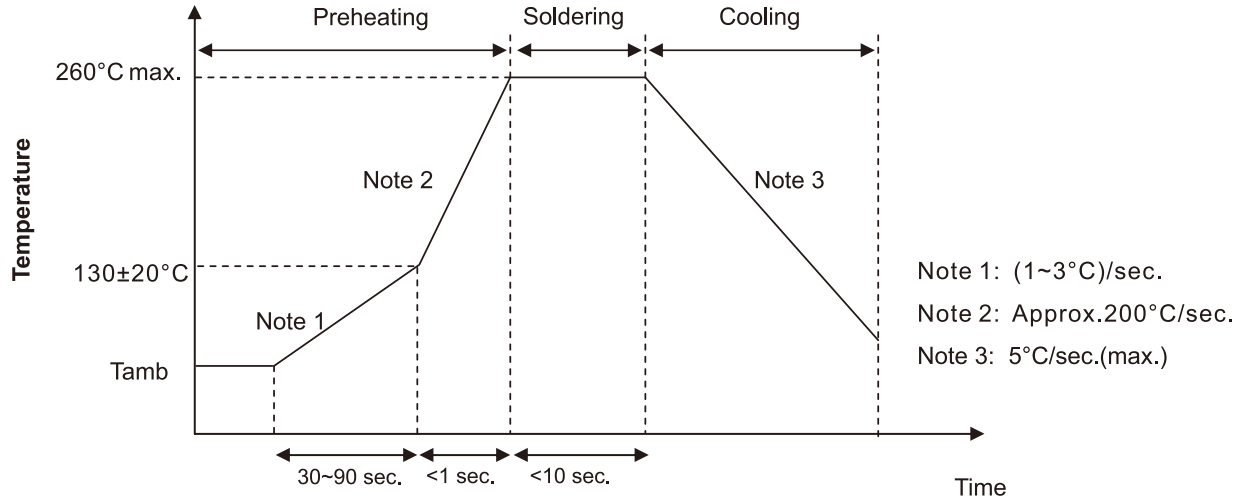

■ Reflow Soldering

- (For Polymer SMD Type)

#### Recommended Reflow Profile

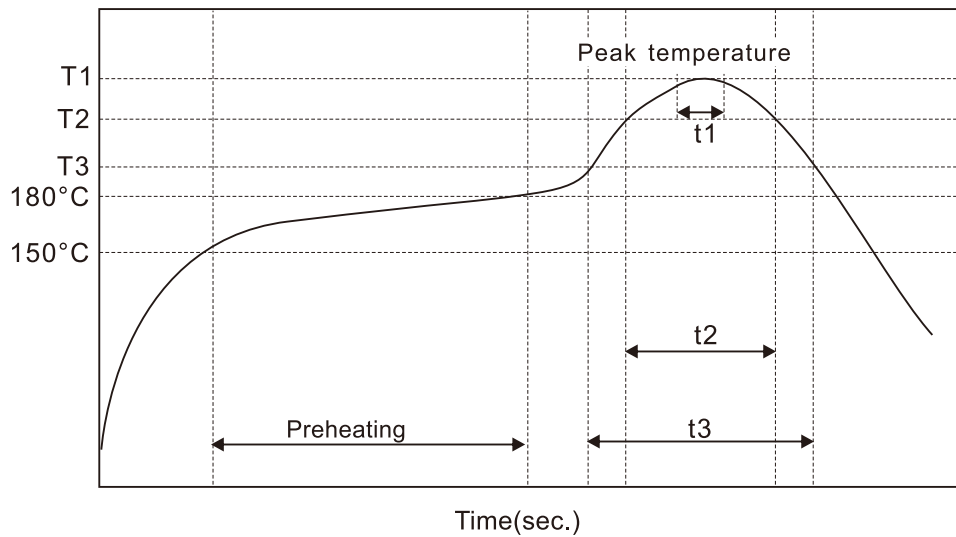

Item	Preheating	T1(°C)	T2(°C)	T3(°C)	t1(sec.)	t2(sec.)	t3(sec.)	Reflow cycle
Condition 1	150°C to 180°C Within 90sec.	≤260	230	200	≤10	≤40	≤60	1
Condition 2		≤250	230	200	≤10	≤40	≤60	2

● (For Liquid SMD Type)

Case size:  $\Phi 6.3$ – $\Phi 10$ mm:

- Temperature at surface of capacitor shall not exceed  $T^{\circ}\text{C}$ .
- The duration for over  $200^{\circ}\text{C}$  temperature and  $T_1^{\circ}\text{C}$  at surface of capacitor shall not exceed  $t$  and  $t_1$  seconds, respectively.
- Preheat shall be done at  $100^{\circ}\text{C}$  to  $200^{\circ}\text{C}$  and for Maximum 180 seconds.

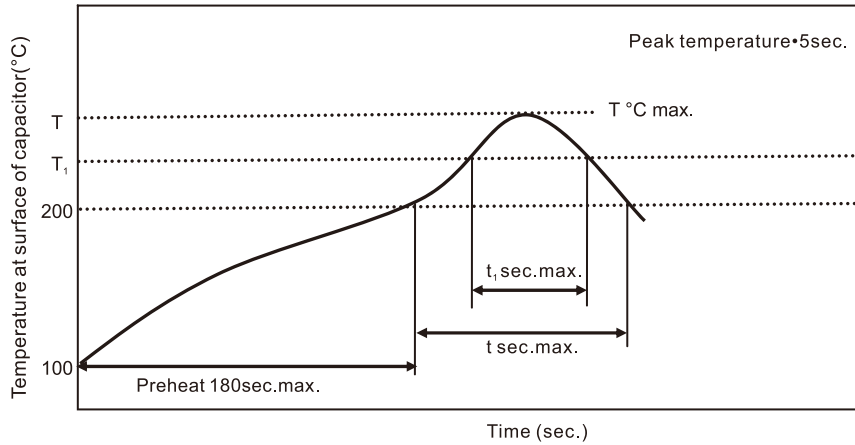

Case size (mm)	$T(^{\circ}\text{C})$ ①	$T_1(^{\circ}\text{C})$	$t(\text{sec.})$ ②	$t_1(\text{sec.})$ ③	Reflow cycle
$\Phi 6.3$	250	230	90	40	1
$\Phi 8$	240	230	90	30	1
$\Phi 10$	235	230	60	30	1

- ① Peak temperature
- ② The duration over  $200^{\circ}\text{C}$  (max.)
- ③ The duration over  $T_1^{\circ}\text{C}$
- Please contact us if capacitors are subject to the conditions other than the allowable range of reflow.

Case size:  $\Phi 12.5$ – $\Phi 18$ mm:

- Temperature at surface of capacitor shall not exceed  $T^{\circ}\text{C}$ .
- The duration for over  $200^{\circ}\text{C}$  temperature and  $T_1^{\circ}\text{C}$  at surface of capacitor shall not exceed  $t$  and  $t_1$  seconds, respectively.
- Preheat shall be done at  $100^{\circ}\text{C}$  to  $180^{\circ}\text{C}$  and for Maximum 150 seconds.

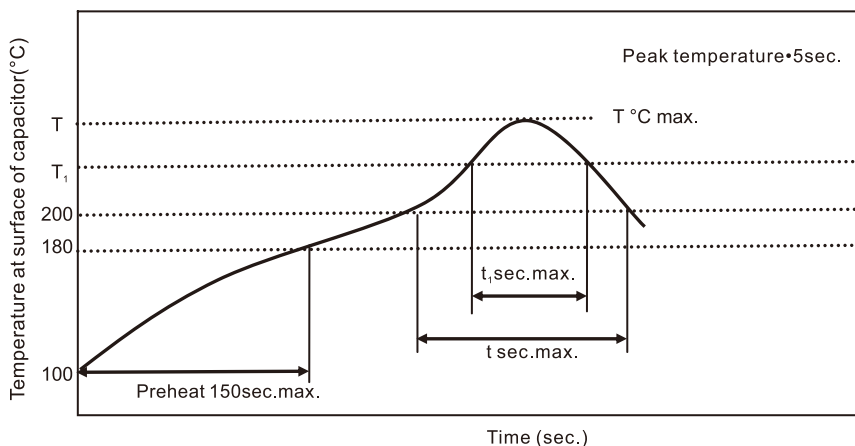

Case size (mm)	$T(^{\circ}\text{C})$ ①	$T_1(^{\circ}\text{C})$	$t(\text{sec.})$ ②	$t_1(\text{sec.})$ ③	Reflow cycle
$\Phi 12.5$ – $\Phi 18$	240	230	60	30	1

- ① Peak temperature
- ② The duration over  $200^{\circ}\text{C}$  (max.)
- ③ The duration over  $T_1^{\circ}\text{C}$
- Please contact us if capacitors are subject to the conditions other than the allowable range of reflow.

# PZ series

- Endurance: +105°C 2,000 hours
- Low ESR
- Recommended Applications: System Board, Display Card, Small Charger and intelligent TV
- RoHS Compliant and lead-free

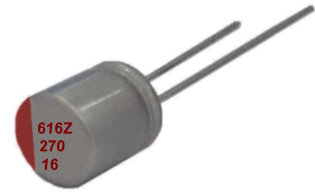

## SPECIFICATIONS

Items	Characteristics	
Category Temperature Range	-55~+105°C	
Rated Working Voltage Range	6.3~100 V <sub>dc</sub>	
Nominal Capacitance Range	4.7~5600μF	
Capacitance Tolerance	±20%(M) (at 20°C, 120Hz)	
DC Leakage Current	I≤0.2CV or 500μA, whichever is greater. Where, I:Max.leakage current (μA),C:Nominal capacitance (μF),V: Rated voltage (V) (at 20°C after 2 minutes)	
Dissipation Factor (tanδ)	Rated Voltage(V <sub>dc</sub> )	6.3 6.8 7.5 10 16 25 35 50 63 100
	tanδ (max.)	0.08 0.12 0.15 (at 20°C, 120Hz)
ESR(100k~300kHz,20°C)	Value in characteristics table	
Temperature Characteristic (Impedance Ratio at 100kHz)	Z(+105°C)/Z(+20°C)≤1.25 Z(-55°C)/Z(+20°C)≤1.25	
Endurance	After applying rated voltage for 2,000 hours at 105°C, the capacitors shall meet the following requirements.	
	Appearance	No significant damage
	Capacitance Change	≤±20% of the initial value
	D.F. (tanδ)	≤150% of the initial specified value
	ESR	≤150% of the initial specified value
Humidity Test	After subjecting to 90%~95% RH for 2,000 hours at 60°C without voltage applied, the capacitors shall meet the specified values for the Endurance characteristics listed above.	
	After subjecting to 1,000 cycles each consisting of charge with the surge voltage specified at normal temperature for 30 seconds through a protective resistor and discharge for 5 minutes 30 seconds, the capacitors shall meet the following requirements.	
	Appearance	No significant damage
	Capacitance Change	≤±20% of the initial value
	D.F. (tanδ)	≤150% of the initial specified value
Surge Test	After subjecting to 1,000 cycles each consisting of charge with the surge voltage specified at normal temperature for 30 seconds through a protective resistor and discharge for 5 minutes 30 seconds, the capacitors shall meet the following requirements.	
	Appearance	No significant damage
	Capacitance Change	≤±20% of the initial value
	D.F. (tanδ)	≤150% of the initial specified value
	ESR	≤150% of the initial specified value
Leakage Current		≤The initial specified value

Conductive Polymer Radial Type

## DIMENSIONS[mm]

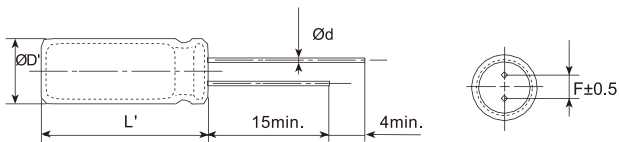

ØD	5	5.5	6.3	6.8	8	10	13
Ød	0.5	0.5	0.5	0.5	0.6	0.6	0.6
F	2.0	2.5	2.5	2.5	3.5	5.0	5.0
ØD'	ØD+0.5max.						
L'	L+1.0max.				L-0.5~+1		L-0.5~+2

## PART NUMBERING SYSTEM

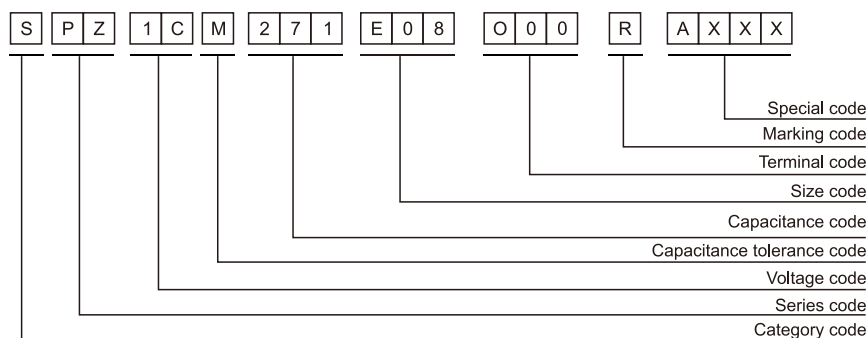



# PZ series

■ STANDARD RATINGS

VDC (SV)	Cap (μF)	Size ΦDxL(mm)	ESR (mΩ,20°C,100kHz)(max.)	Rated ripple current (mA <sub>rms</sub> /105°C,100kHz)	Leakage Current (μA)(max.)
6.3 (7.2)	47	6.3*5	40	1100	500
	82	6.3*5	40	1100	500
	100	4*7	30	1500	500
		5*7	30	1800	500
	150	6.3*6	40	1900	500
		4*7	30	2100	500
	180	5*7	30	2600	500
	220	5*7	20	3500	500
		6.3*7	20	3550	500
	270	6.3*8	15	3600	500
		5*7	20	3800	500
	330	5*6	20	3200	500
		5*8	20	4000	500
	390	6.3*5	25	3160	500
		6.3*8	15	4000	500
	470	5*9	20	4100	500
		5*10	20	4300	592
	500	5.5*9	20	4100	592
		6.3*7	20	3900	592
	560	6.3*8	15	4400	592
		5*9	20	4100	630
	680	6.3*7	20	4200	706
		6.3*8	20	4800	706
	820	5.5*9	20	4300	706
		6.3*9	20	5080	857
	1000	5.5*9	20	4800	857
		8*9	20	4600	857
	1200	5.5*10	20	4800	1033
		6.3*9	20	5080	1033
	1500	8*9	15	4700	1033
6.3*10		10	5150	1260	
1800	8*9	12	4800	1260	
	8*11	10	5200	1260	
2200	6.3*11	10	5200	1512	
	8*11	10	5300	1512	
3300	8*11	10	5400	1890	
	10*12	10	5500	1890	
4700	10*10	10	5560	2268	
	8*14	10	5700	2772	
5600	10*12	10	5800	2772	
	10*14	10	5900	4158	
6300	10*17	10	6100	5000	
	10*18	10	6300	5000	
6.8 (7.8)	220	5*7	20	3300	500
	270	5*7	20	3600	500
		6.3*8	20	3900	500
	330	5*8	20	3800	500
		6.3*5	25	3100	500
	390	6.3*7	20	3400	500
		5*9	20	3900	530
	470	5*9	20	4100	639
		6.3*7	20	3700	639
	560	6.3*8	20	4500	762
	680	6.3*9	20	4800	925
	820	6.3*9	20	4900	1115
6.3*11		12	5100	1360	
1000	8*11	10	5150	1360	
7 (8)	150	5*6	30	1500	500
	220	5*7	20	3200	500
	270	5*8	20	3400	500
	330	5*9	20	3600	500
	470	6.3*8	20	3800	658
		5.5*9	20	3600	658
	560	6.3*8	20	4000	784
	680	6.3*9	12	4200	952
820	6.3*10	12	4500	1148	
	8*9	12	4600	1148	
7.5 (8.6)	220	5*7	20	3100	500
	270	5*8	20	3300	500
	330	5*9	20	3500	500
	390	5*9	20	3500	585
		6.3*7	25	3200	705
	470	5.5*9	20	3550	705
		5*9	20	3550	705
	500	5.5*8	25	3100	705
	560	5.5*9	20	3600	750
	680	6.3*8	20	3900	840
		6.3*9	12	4100	1020
	820	6.8*8	20	4000	1020
		6.3*10	12	4400	1230
	1000	8*9	12	4550	1230
		8*11	12	4700	1500
	1200	6.3*11	12	4500	1500
8*11		12	4800	1800	
	6.8*11	12	4600	1800	



# PZ series

■ STANDARD RATINGS

VDC (SV)	Cap (μF)	Size ΦDxL(mm)	ESR (mΩ,20°C,100kHz)(max.)	Rated ripple current (mArms/105°C,100kHz)	Leakage Current (μA)(max.)
7.5 (8.6)	1500	8*11	12	4900	2250
	1800	7*13	12	4800	2250
	1800	8*14	12	5100	2700
	2200	10*12	12	5700	3300
10 (11.5)	47	5*7	35	2200	500
	56	5*7	35	2250	500
	68	5*7	35	2300	500
	82	5*7	35	2350	500
		5*7	35	2400	500
	100	6.3*5	30	2300	500
		5*5	30	2000	500
	120	5*7	20	2450	500
	150	5*7	20	2500	500
	180	6.3*7	20	2800	500
		5*8	20	2700	500
		5*9	20	2820	500
	220	6.3*5	25	2800	500
		6.3*8	15	3160	500
	270	6.3*8	20	3100	540
		6.3*8	20	3300	660
	330	8*9	15	3400	660
		6.3*10	12	3500	660
	390	6.3*8	20	3400	780
		5.5*9	20	3400	940
	470	6.3*8	20	3500	940
		8*9	15	3550	940
		8*11	12	5650	940
	560	6.3*10	13	3600	1120
		8*9	15	3600	1120
		6.3*11	15	3800	1360
	680	8*11	12	3900	1360
		8*8	20	3300	1360
	820	8*11	12	4000	1640
		8*11	12	4200	2000
	1000	10*12	10	5300	2000
		8*12	10	4500	2400
1200	10*12	10	5450	2400	
	10*12	10	5500	3000	
1500	8*14	10	4800	3000	
1800	10*13	10	5800	3600	
2200	10*15	10	6100	4400	
3300	10*18	10	6200	5000	
220	4*10	15	2100	528	
12 (13.8)	330	5.5*9	20	3100	792
		6.3*8	20	3100	792
	470	5*10	20	3100	792
		5.5*9	20	3200	1128
	560	6.3*9	20	3450	1128
		6.3*10	15	3400	1344
	680	6.3*11	15	3600	1632
		8*10	15	3700	1632
	820	8*11	12	3800	1968
		6.8*11	13	3200	1968
	1000	8*12	12	4000	2400
	1200	8*14	12	4400	2880
	1500	8*16	12	4800	3600
	16 (18.4)	22	5*9	80	1600
47		5*7	20	2050	500
56		5*7	20	2100	500
68		5*7	20	2150	500
82		5*8	20	2200	500
		5*7	20	2250	500
100		6.3*5	25	2100	500
		6.3*8	20	2800	500
120		5*8	20	2350	500
150		5*8	20	2400	500
180		5*8	20	2450	576
		6.3*7	16	2500	576
		5*10	20	2600	704
220		6.3*8	20	2700	704
		6.3*10	15	2900	704
		5.5*9	20	2750	864
270		6.3*8	20	2800	864
		8*9	20	2900	864
		5.5*9	20	2900	1056
330		6.3*9	20	2900	1056
		6.3*10	15	3100	1056
		5.5*10	20	3000	1504
470		6.3*11	15	3100	1504
		8*11	11	4600	1504
		8*9	13	4100	1504
		8*11	11	3200	1792
560		8*13	11	3300	1792
		10*12	11	3500	1792
		8*11	11	3400	2176
680		10*12	11	3600	2176
		6.8*11	11	3200	2176
		8*13	11	3500	2624
820		10*12	11	3800	2624
		10*12	11	4000	3200
1000		8*14	11	3600	3200

Conductive Polymer Radial Type

# PZ series

■ STANDARD RATINGS

VDC (SV)	Cap (μF)	Size ΦDxL (mm)	ESR (mΩ, 20°C, 100kHz)(max.)	Rated ripple current (mArms/105°C, 100kHz)	Leakage Current (μA)(max.)	
16 (18.4)	1200	10*15	11	4300	3840	
		10*12	11	4200	3840	
	1500	10*12	11	4800	4800	
		10*18	11	5500	4800	
	1800	10*14	11	5400	5000	
		10*17	11	5800	5000	
	2200	10*15	11	5500	5000	
	3300	13*18	11	6100	5000	
20 (23)	33	5*8	40	1900	500	
	39	5*8	40	1950	500	
	47	5*8	40	2200	500	
	56	5*9	40	2100	500	
	68	6.3*8	30	2100	500	
	82	6.3*8	30	2150	500	
	100	6.3*8	30	2200	500	
	120	6.3*8	30	2300	500	
	150	6.3*10	20	2350	600	
	180	8*9	30	2450	720	
	220	8*11	20	2550	880	
	270	8*11	20	2700	1080	
		330	8*11	20	2800	1320
			6.3*11	20	2100	1320
			10*12	20	2900	1880
	470	8*16	20	3000	1880	
			8*11	20	2400	1880
			10*12	20	3100	2240
	560	8*16	20	3200	2240	
	680	10*15	20	3300	2720	
		8*14	20	2700	2720	
820	10*18	20	3400	3280		
1000	10*18	20	3900	4000		
25 (29)	6.8	6.3*6	100	1100	500	
	10	5*8	70	1800	500	
	22	5*9	60	1810	500	
	33	5*9	50	1850	500	
	39	5*8	40	1900	500	
	47	5*9	40	1950	500	
	56	5*9	40	2050	500	
	68	6.3*7	30	2100	500	
	82	6.3*7	30	2150	500	
			6.3*8	30	2200	500
	100	6.3*10	20	2300	500	
			8*11	20	2450	500
	120	6.3*8	30	2300	600	
	150	6.3*10	20	2350	750	
	180	6.3*10	20	2350	900	
			8*9	30	2450	900
			8*11	20	2550	1100
	220	10*12	20	2900	1100	
			5.5*10	20	1900	1100
	270	8*11	20	2700	1350	
			8*11	20	2800	1650
	330	10*12	20	3100	1650	
			10*10	25	2800	1650
			10*12	20	2800	2350
	470	8*16	20	2700	2350	
			8*11	20	2300	2350
		10*10	25	2300	2350	
560	10*12	20	3000	2800		
		8*11	20	2400	2800	
680	10*15	20	3200	3400		
		10*12	20	2800	3400	
820	10*18	20	3300	4100		
		10*12	20	2600	4100	
		8*16	20	2600	4100	
1000	10*18	20	3800	5000		
1500	13*16	20	4000	5000		
35 (41)	4.7	5*8	60	1700	500	
	10	5*8	60	1800	500	
	15	5*8	60	1850	500	
	22	5*9	100	1950	500	
	33	5*9	50	2000	500	
	39	5*9	50	2050	500	
	47	6.3*7	50	2100	500	
	56	6.3*7	50	2150	500	
	68	6.3*7	50	2200	500	
	82	6.3*7	50	2250	574	
			6.3*8	50	2350	700
	100	6.3*10	40	2400	700	
			8*11	40	2600	700
	120	6.3*10	40	2500	840	
	150	6.3*10	40	2550	1050	
	180	6.3*11	40	2600	1260	
			8*11	40	2800	1540
	220	10*12	30	2900	1540	
			6.3*11	30	2700	1540
	270	10*12	30	3000	1890	
	330	10*12	30	3100	2310	
	470	10*13	20	3200	3290	

# PZ series

■ STANDARD RATINGS

VDC (SV)	Cap (μF)	Size ΦDxL(mm)	ESR (mΩ,20°C,100kHz)(max.)	Rated ripple current (mArms/105°C,100kHz)	Leakage Current (μA)(max.)
35 (41)	560	10*14	20	3300	3920
	680	10*16	20	3400	4760
	820	10*18	20	3500	5000
	1000	10*18	20	3700	5000
50 (58)	4.7	5*8	60	1600	500
	10	6.3*7	35	1850	500
		5*8	70	1630	500
	15	5*8	70	1660	500
	22	6.3*7	40	1900	500
	33	6.3*7	40	2000	500
	47	6.3*8	35	2100	500
	56	6.3*8	35	2120	560
	68	6.3*10	30	2150	680
	100	8*11	30	2300	1000
		8*9	40	2100	1000
	120	8*11	30	2400	1200
	150	10*12	30	2500	1500
	180	10*12	30	2600	1800
	220	10*12	30	2700	2200
	270	10*13	20	2900	2700
330	10*15	20	3000	3300	
440	10*18	20	3100	4400	
470	10*18	20	3150	4700	
680	13*18	20	3300	5000	
63 (73)	4.7	6.3*8	60	1600	500
	6.8	6.3*8	60	1650	500
	10	6.3*5	60	1600	500
	33	6.3*8	30	1700	500
	39	6.3*8	30	1750	500
	47	6.3*9	30	1900	592
	56	8*9	30	1800	706
	68	8*11	30	2000	857
	82	8*11	30	2100	1033
	100	10*12	30	2200	1260
	150	10*12	30	2500	1890
	180	10*13	20	2600	2268
	220	10*15	20	2650	2772
	270	10*17	20	2850	3402
	330	10*18	20	2950	4158
	470	13*18	20	3100	5000
80 (92)	4.7	6.3*8	60	1500	500
	6.8	6.3*8	60	1550	500
	22	6.3*10	60	1650	500
	33	8*11	35	1700	528
	47	10*12	35	1850	752
	68	10*12	35	1900	1088
	100	10*14	35	2100	1600
	220	13*18	35	2700	4400
100 (115)	4.7	6.3*8	60	1400	500
	6.8	6.3*8	60	1450	500
	10	6.3*10	50	1500	500
	15	8*11	50	1550	500
	22	10*12	35	1600	500
	33	10*14	35	1650	660
	47	10*16	35	1800	940

Conductive Polymer Radial Type

※ Specifications subject to change without notice.