

# HSF

NOTES:  
 Current Rating: 3.0AMP  
 Contact Resistance: 20mΩ Max  
 Withstand Voltage: 1000V AC/DC  
 Insulation Resistance: 1000MΩ Min  
 Operation Temperature: -40°C to +105°C

Contact Material: Brass  $\Delta$   
 Contact plating: Au over Ni  
 Insulator Material: PBT+30%G.F UL94V-0  
 10~16Pin Without "A"

## Ordering Information

3810-XX XX W X N 0 X

No. of Pins	Contact Plating	Insulator Colour	Logo
10 30	S0=Gold Flash/Ni	G=Gray(427C)	
14 34	S3=10u"Gold/Ni	E=Gray(413C)	
16 40	S4=15u"Gold/Ni	B=Black	N=Without Logo
20 50	S5=30u"Gold/Ni		W=With Logo
24 60			
26 64			

Item	Pitch	Mating
Standard	2.54	5212/5211
Alternate		

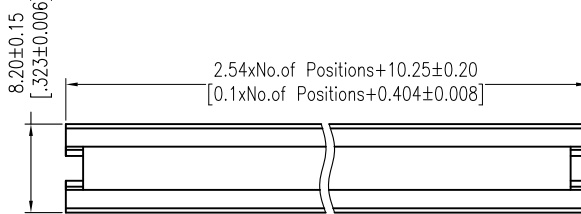
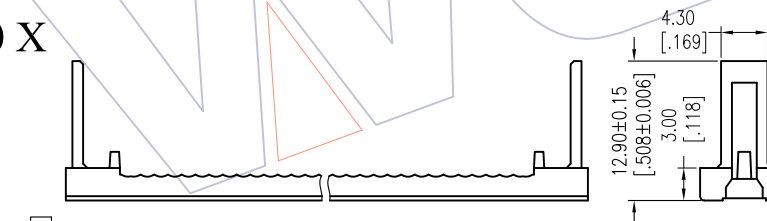
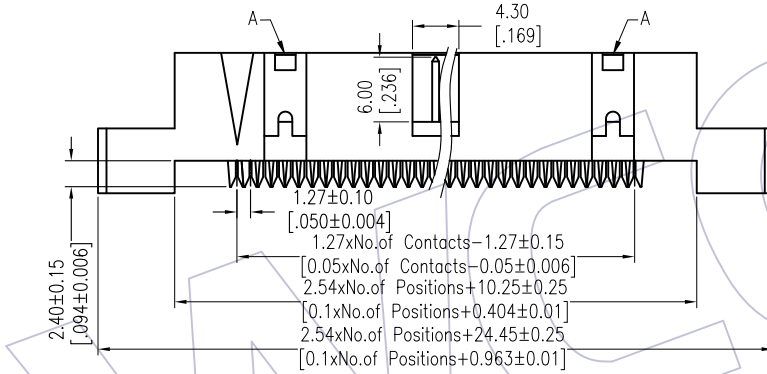
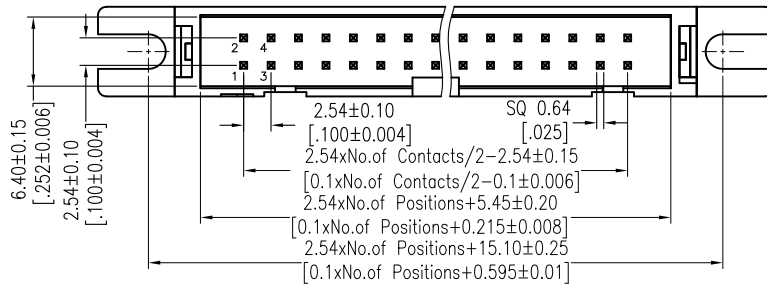

COVER P/N: G3810-XXXXC01  $\Delta$

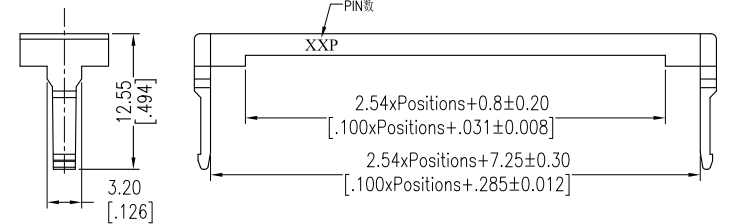
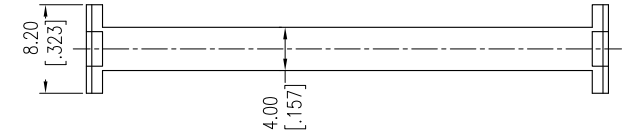
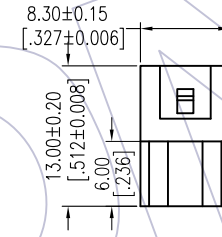

SR P/N: G3810-XXXXD01  $\Delta$

REV	DATE	MODIFICATION DESCRIPTION	CHANGE	OPERATION	DRAW	DATE	SCALE	FIT	PART NO.
A3	2018/01/11	MODIFY	-----	OPERATION	DRAW	2018/01/11	UNIT		3810-XXXXWXNOX
A2	2012/12/24	MODIFY THE NOTES: Phosphor Bronze → Brass	-----	x.X ±0.40	Ding		mm		
A1	2012/11/22	Modify The Contact Plating	-----	x.XX ±0.25	CHECK		SIZE	A4	TITLE: 2.54mm BOX HEADER IDC TYPE 带定位孔
A0	2012/09/25	NEW	-----	x.XXX ±0.15			SHEET	1/1	
				Angle ± 3'	APPROVE		PROJ.		Customer NO.
				DIM TOL					

# WCON

Http: www.wcon.com

WCON-Dongguan Tel: +86 769 85358920 Fax: +86 769 85358915 E-mail: sales@wcon.com	WCON-Kunshan Tel: +86 512 57468408 Fax: +86 512 57468468 E-mail: salesks@wcon.com
-------------------------------------------------------------------------------------------	--------------------------------------------------------------------------------------------