



A3961 SERIES

3.96~7.92mm pitch wire to board connector

Specifications

- Current rating:7A AC,DC
- Voltage rating:250V AC,DC
- Temperature range:-40°C~+105°C
- Contact resistance:10mΩMax.
- Insulation resistance:1000MΩMin.
- Withstanding voltage:1500V AC/minute
- *Compliant with RoHS and REACH*
- *Meet the HF/Halogen Free,GWT/Glow wire Test (IEC60335-1) request,need to customize*
- *Contact CJT for details*

Standards

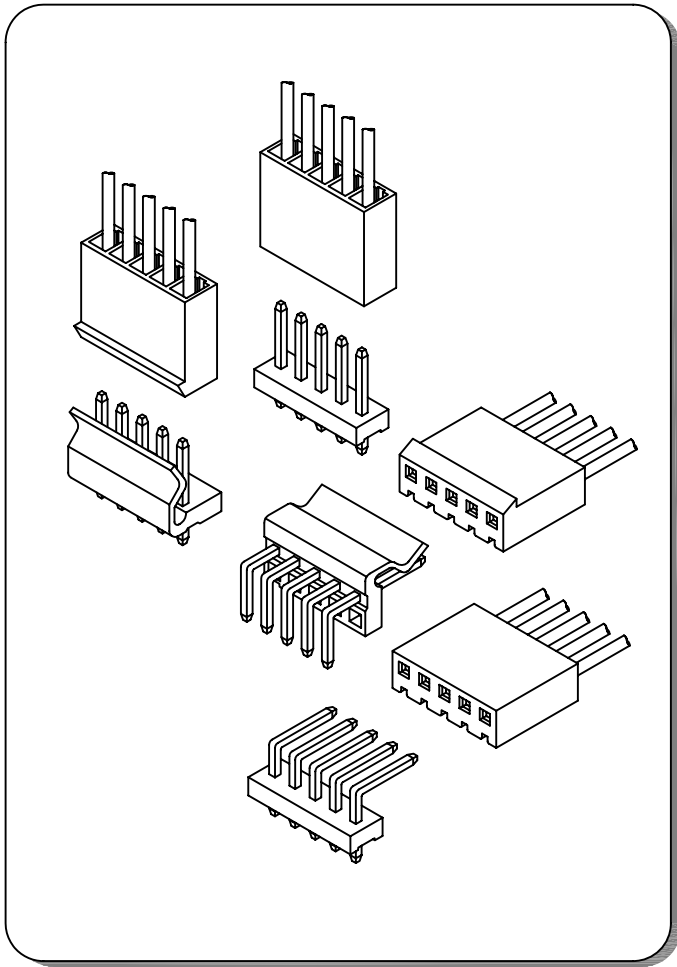

Assembly layout

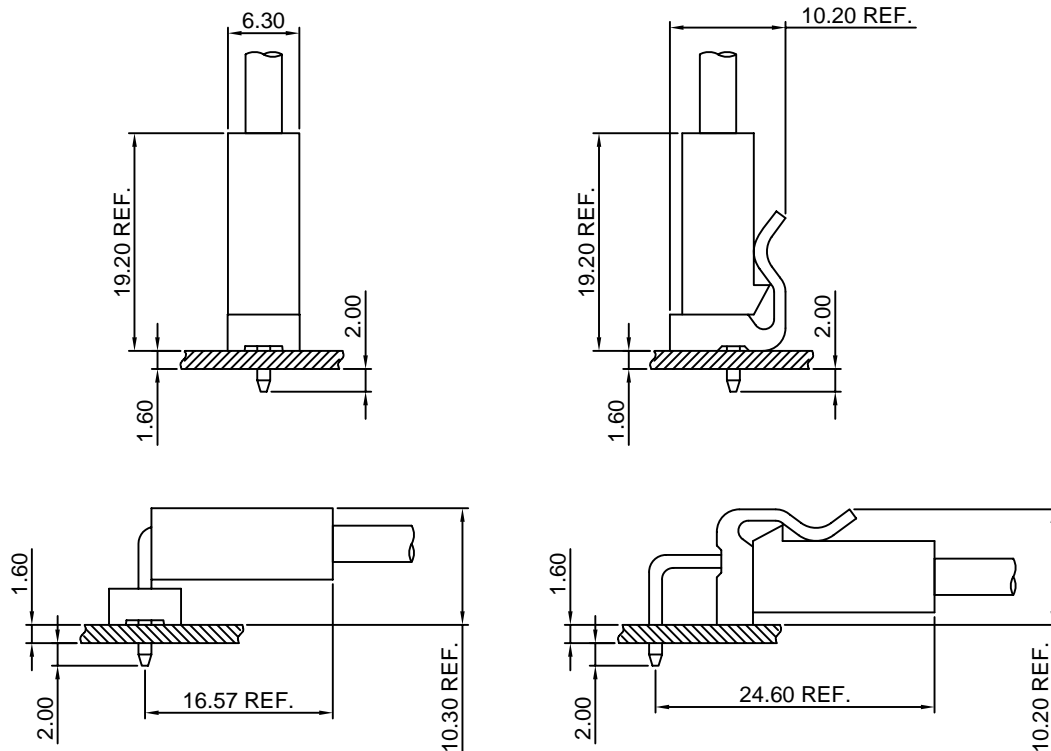

A3961-T

3.96mm pitch Crimp Terminal

Reference Informations:

*Used in CJT A3961 series Housing

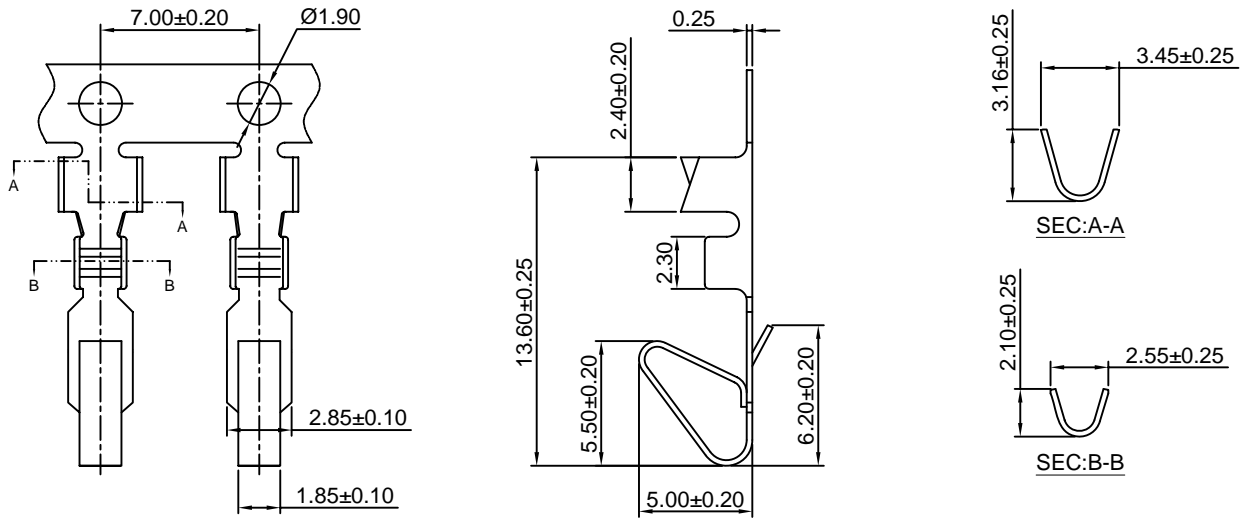

Ordering information & Specifications:

Unit:mm

Part NO.	Wire Range	Insulation O.D.	Material	Finish	Qty/reel
A3961-TB	AWG#18-#24	2.80mm(max)	Brass	Tin over Nickel	6,000 PCS
A3961-TP	AWG#18-#24	2.80mm(max)	Phosphor Bronze	Tin over Nickel	6,000 PCS
A3961-GB	AWG#18-#24	2.80mm(max)	Brass	Gold over Nickel	6,000 PCS
A3961-GP	AWG#18-#24	2.80mm(max)	Phosphor Bronze	Gold over Nickel	6,000 PCS

Optional Gold plating available but MOQ requested

A3961-T-1

3.96mm pitch Crimp Terminal

Reference Informations:

*Used in CJT A3961 series Housing

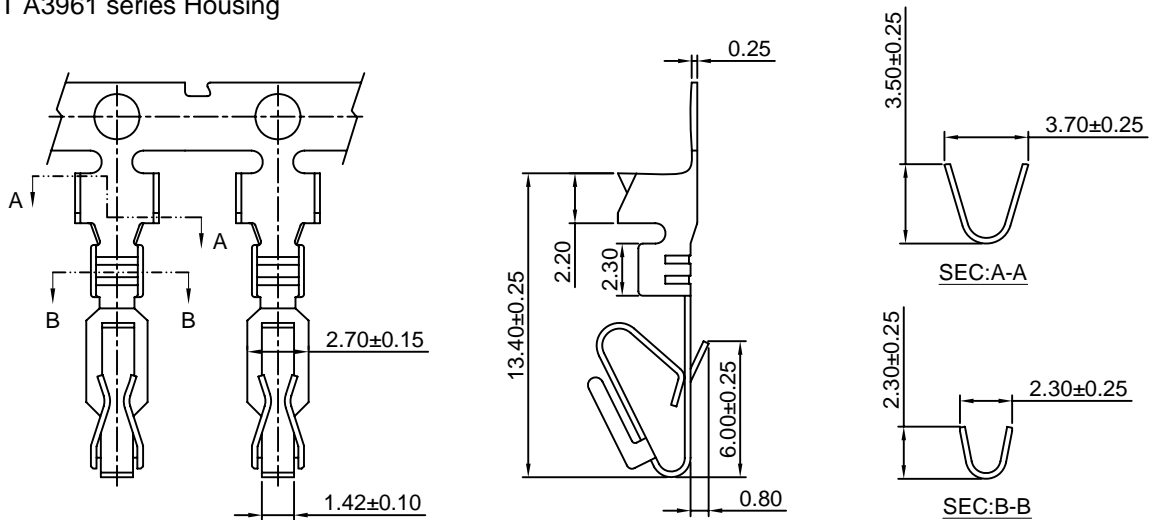

Ordering information & Specifications:

Unit:mm

Part NO.	Wire Range	Insulation O.D.	Material	Finish	Qty/reel
A3961-TB-1	AWG#18-#24	2.80mm(max)	Brass	Tin over Nickel	6,000 PCS
A3961-TP-1	AWG#18-#24	2.80mm(max)	Phosphor Bronze	Tin over Nickel	6,000 PCS
A3961-GB-1	AWG#18-#24	2.80mm(max)	Brass	Gold over Nickel	6,000 PCS
A3961-GP-1	AWG#18-#24	2.80mm(max)	Phosphor Bronze	Gold over Nickel	6,000 PCS

Optional Gold plating available but MOQ requested



A3961 SERIES

3.96mm pitch wire to board connector

A3961H

3.96mm pitch Housing

Reference Informations:

- *Material:Nylon 66,UL94V-2
- *Suitable CJT A3961 series Terminal
- *Mates with CJT A3961 series Wafer
- *Color:Natural

Ordering Information:

- A3961H-XP - *
 1 2
 1.Part No.
 2.Material:
 (blank)-UL94V-2
 V0-UL94V-0

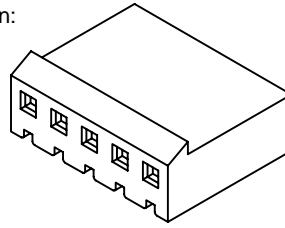

Ordering Information & Dimensions:

PART NO.	Dimensions	
	A	B
A3961H-2P	3.96	8.43
A3961H-3P	7.92	12.39
A3961H-4P	11.88	16.35
A3961H-5P	15.84	20.31
A3961H-6P	19.80	24.27
A3961H-7P	23.76	28.23
A3961H-8P	27.72	32.19
A3961H-9P	31.68	36.15
A3961H-10P	35.64	40.11
A3961H-11P	39.60	44.07
A3961H-12P	43.56	48.03
A3961H-13P	47.52	51.99
A3961H-14P	51.48	55.95
A3961H-15P	55.44	59.91
A3961H-16P	59.40	63.87
A3961H-17P	63.36	67.83
A3961H-18P	67.32	71.79
A3961H-19P	71.28	75.75
A3961H-20P	75.24	79.71
A3961H-21P	79.20	83.67
A3961H-22P	83.16	87.63
A3961H-23P	87.12	91.59
A3961H-24P	91.08	95.55

Unit: mm

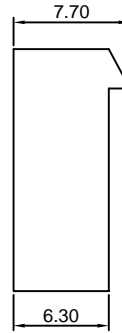
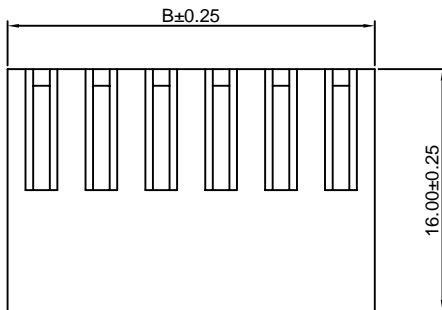
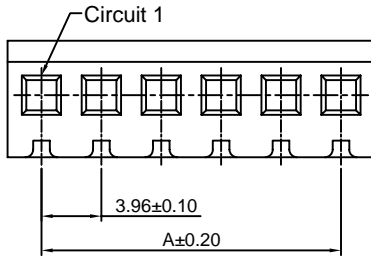

A3961H-2

3.96mm pitch Housing

Reference Informations:

- *Material:Nylon 66,UL94V-2
- *Suitable CJT A3961 series Terminal
- *Mates with CJT A3961 series Wafer
- *Color:Natural

Ordering Information:

- A3961H-XP-2 - *
 1 2
 1.Part No.
 2.Material:
 (blank)-UL94V-2
 V0-UL94V-0

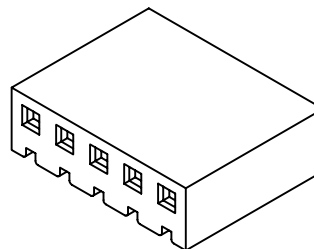

Ordering Information & Dimensions:

PART NO.	Dimensions	
	A	B
A3961H-2P-2	3.96	8.43
A3961H-3P-2	7.92	12.39
A3961H-4P-2	11.88	16.35
A3961H-5P-2	15.84	20.31
A3961H-6P-2	19.80	24.27
A3961H-7P-2	23.76	28.23
A3961H-8P-2	27.72	32.19
A3961H-9P-2	31.68	36.15
A3961H-10P-2	35.64	40.11
A3961H-11P-2	39.60	44.07
A3961H-12P-2	43.56	48.03
A3961H-13P-2	47.52	51.99
A3961H-14P-2	51.48	55.95
A3961H-15P-2	55.44	59.91
A3961H-16P-2	59.40	63.87
A3961H-17P-2	63.36	67.83
A3961H-18P-2	67.32	71.79
A3961H-19P-2	71.28	75.75
A3961H-20P-2	75.24	79.71
A3961H-21P-2	79.20	83.67
A3961H-22P-2	83.16	87.63
A3961H-23P-2	87.12	91.59
A3961H-24P-2	91.08	95.55

Unit: mm

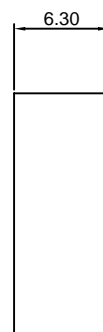
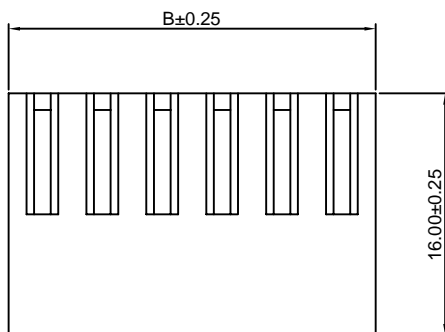
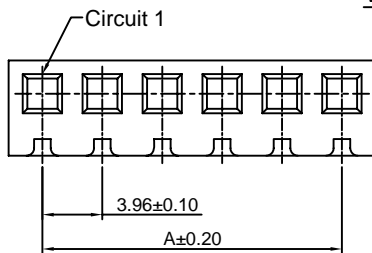



A3961 SERIES

3.96mm pitch wire to board connector

A3961H-3

3.96mm pitch Housing

Reference Informations:

- *Material:Nylon 66,UL94V-2
- *Suitable CJT A3961 series Terminal
- *Mates with CJT D3961WV D3961WR series Wafer
- *Color:Natural

Ordering Information:

- A3961H-XP-3 - $\frac{*}{2}$
 1
 2
- 1.Part No.
 - 2.Material:
 (blank)-UL94V-2
 V0-UL94V-0

Ordering Information & Dimensions:

PART NO.	Dimensions	
	A	B
A3961H-2P-3	3.96	8.43
A3961H-3P-3	7.92	12.39
A3961H-4P-3	11.88	16.35
A3961H-5P-3	15.84	20.31
A3961H-6P-3	19.80	24.27
A3961H-7P-3	23.76	28.23
A3961H-8P-3	27.72	32.19
A3961H-9P-3	31.68	36.15
A3961H-10P-3	35.64	40.11
A3961H-11P-3	39.60	44.07
A3961H-12P-3	43.56	48.03
A3961H-13P-3	47.52	51.99
A3961H-14P-3	51.48	55.95
A3961H-15P-3	55.44	59.91
A3961H-16P-3	59.40	63.87
A3961H-17P-3	63.36	67.83
A3961H-18P-3	67.32	71.79
A3961H-19P-3	71.28	75.75
A3961H-20P-3	75.24	79.71
A3961H-21P-3	79.20	83.67
A3961H-22P-3	83.16	87.63
A3961H-23P-3	87.12	91.59
A3961H-24P-3	91.08	95.55

Unit: mm

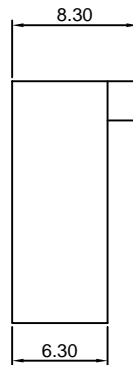
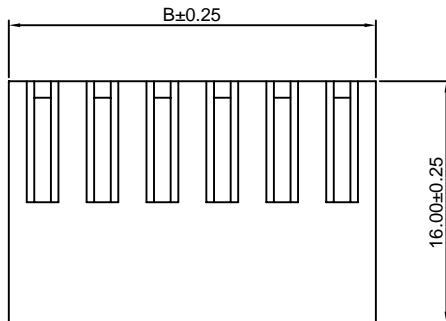
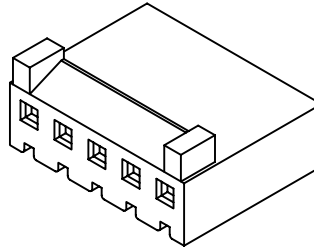
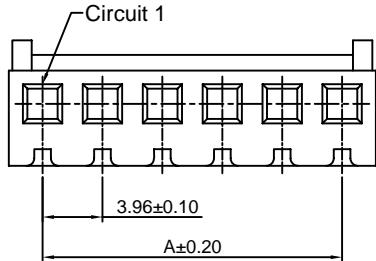

A3961WV

3.96mm pitch 180° Wafer

Reference Informations:

- *Material:Pin:Brass/Tin over Nickel
 Insulator:Nylon 66,UL94V-2
- *Mates with CJT A3961 or A3964 series Housing
- *Color:Natural

Ordering Information & Dimensions:

PART NO.	Dimensions	
	A	B
A3961WV-2P	3.96	7.92
A3961WV-3P	7.92	11.88
A3961WV-4P	11.88	15.84
A3961WV-5P	15.84	19.80
A3961WV-6P	19.80	23.76
A3961WV-7P	23.76	27.72
A3961WV-8P	27.72	31.68
A3961WV-9P	31.68	35.64
A3961WV-10P	35.64	39.60
A3961WV-11P	39.60	43.56
A3961WV-12P	43.56	47.52
A3961WV-13P	47.52	51.48
A3961WV-14P	51.48	55.44
A3961WV-15P	55.44	59.40
A3961WV-16P	59.40	63.36
A3961WV-17P	63.36	67.32
A3961WV-18P	67.32	71.28
A3961WV-19P	71.28	75.24
A3961WV-20P	75.24	79.20
A3961WV-21P	79.20	83.16
A3961WV-22P	83.16	87.12
A3961WV-23P	87.12	91.08
A3961WV-24P	91.08	95.04

Unit: mm

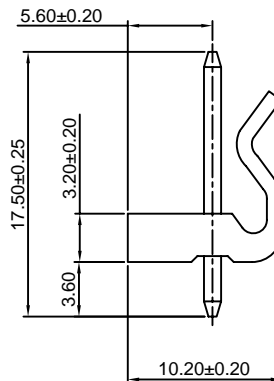
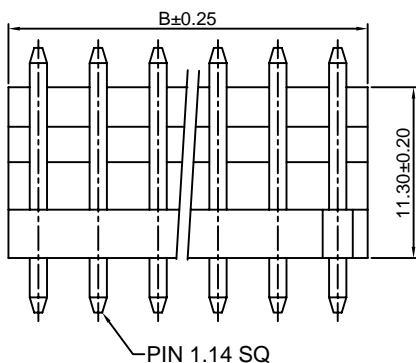
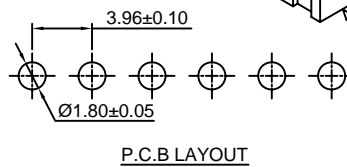
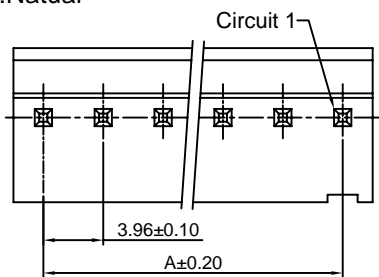

A3961WR-B

3.96mm pitch 90° Wafer

Reference Informations:

- *Material:Pin:Brass/Tin over Nickel
Insulator:Nylon 66,UL94V-2
- *Mates with CJT A3961 or A3964 series Housing
- *Color:Natural

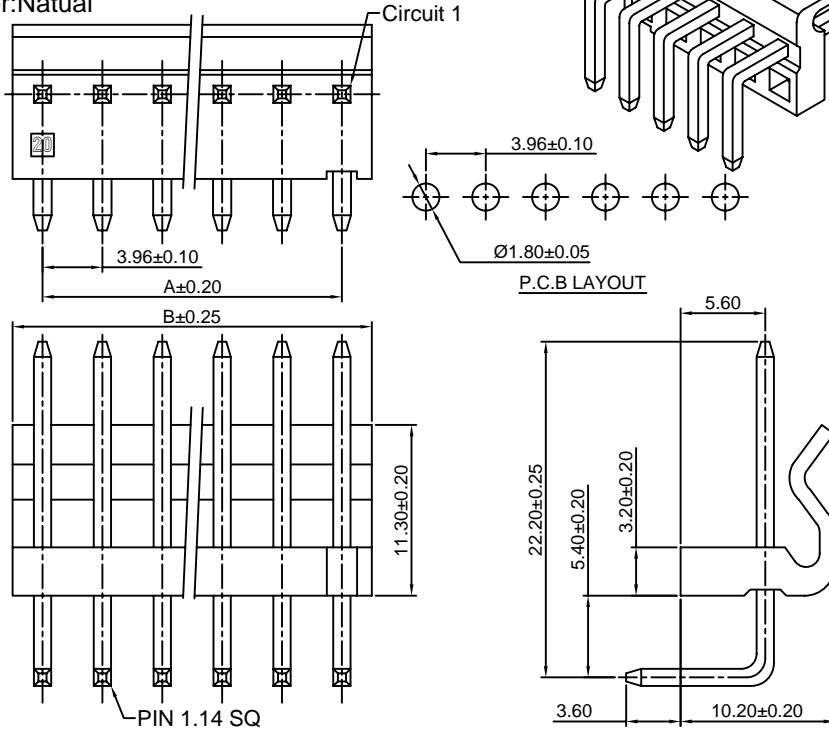

Ordering Information & Dimensions:

PART NO.	Dimensions	
	A	B
A3961WR-2P-B	3.96	7.92
A3961WR-3P-B	7.92	11.88
A3961WR-4P-B	11.88	15.84
A3961WR-5P-B	15.84	19.80
A3961WR-6P-B	19.80	23.76
A3961WR-7P-B	23.76	27.72
A3961WR-8P-B	27.72	31.68
A3961WR-9P-B	31.68	35.64
A3961WR-10P-B	35.64	39.60
A3961WR-11P-B	39.60	43.56
A3961WR-12P-B	43.56	47.52
A3961WR-13P-B	47.52	51.48
A3961WR-14P-B	51.48	55.44
A3961WR-15P-B	55.44	59.40
A3961WR-16P-B	59.40	63.36
A3961WR-17P-B	63.36	67.32
A3961WR-18P-B	67.32	71.28
A3961WR-19P-B	71.28	75.24
A3961WR-20P-B	75.24	79.20
A3961WR-21P-B	79.20	83.16
A3961WR-22P-B	83.16	87.12
A3961WR-23P-B	87.12	91.08
A3961WR-24P-B	91.08	95.04

Unit: mm

A3961WVA

3.96mm pitch 180° Wafer

Reference Informations:

- *Material:Pin:Brass/Tin over Nickel
Insulator:Nylon 66,UL94V-2
- *Mates with CJT A3961 or A3964 series Housing
- *Color:Natural

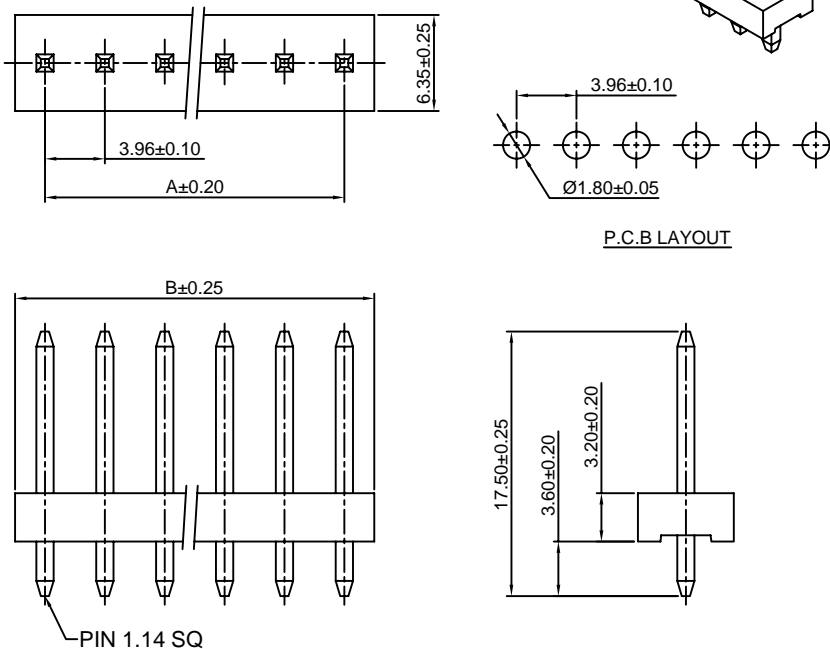

Ordering Information & Dimensions:

PART NO.	Dimensions	
	A	B
A3961WVA-2P	3.96	7.92
A3961WVA-3P	7.92	11.88
A3961WVA-4P	11.88	15.84
A3961WVA-5P	15.84	19.80
A3961WVA-6P	19.80	23.76
A3961WVA-7P	23.76	27.72
A3961WVA-8P	27.72	31.68
A3961WVA-9P	31.68	35.64
A3961WVA-10P	35.64	39.60
A3961WVA-11P	39.60	43.56
A3961WVA-12P	43.56	47.52
A3961WVA-13P	47.52	51.48
A3961WVA-14P	51.48	55.44
A3961WVA-15P	55.44	59.40
A3961WVA-16P	59.40	63.36
A3961WVA-17P	63.36	67.32
A3961WVA-18P	67.32	71.28
A3961WVA-19P	71.28	75.24
A3961WVA-20P	75.24	79.20
A3961WVA-21P	79.20	83.16
A3961WVA-22P	83.16	87.12
A3961WVA-23P	87.12	91.08
A3961WVA-24P	91.08	95.04

Unit: mm

A3961WRA

3.96mm pitch 90° Wafer

Reference Informations:

- *Material:Pin:Brass/Tin over Nickel
Insulator:Nylon 66,UL94V-2
- *Mates with CJT A3961 or A3964 series Housing
- *Color:Natural

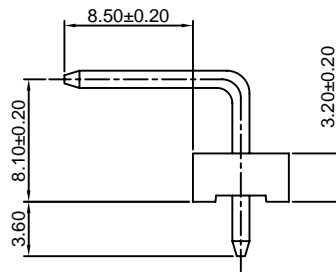
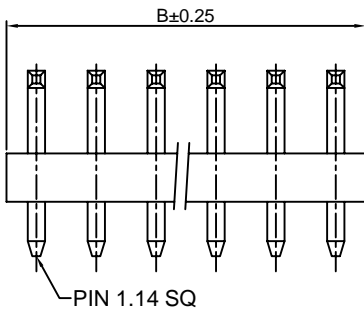
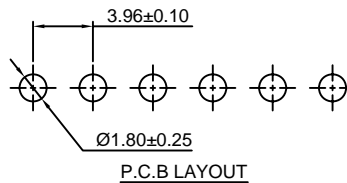
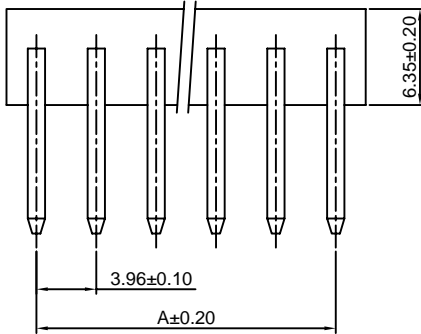
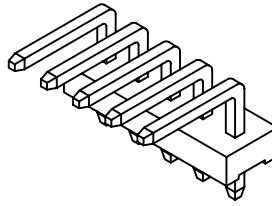

Ordering Information & Dimensions:

PART NO.	Dimensions	
	A	B
A3961WRA-2P	3.96	7.92
A3961WRA-3P	7.92	11.88
A3961WRA-4P	11.88	15.84
A3961WRA-5P	15.84	19.80
A3961WRA-6P	19.80	23.76
A3961WRA-7P	23.76	27.72
A3961WRA-8P	27.72	31.68
A3961WRA-9P	31.68	35.64
A3961WRA-10P	35.64	39.60
A3961WRA-11P	39.60	43.56
A3961WRA-12P	43.56	47.52
A3961WRA-13P	47.52	51.48
A3961WRA-14P	51.48	55.44
A3961WRA-15P	55.44	59.40
A3961WRA-16P	59.40	63.36
A3961WRA-17P	63.36	67.32
A3961WRA-18P	67.32	71.28
A3961WRA-19P	71.28	75.24
A3961WRA-20P	75.24	79.20
A3961WRA-21P	79.20	83.16
A3961WRA-22P	83.16	87.12
A3961WRA-23P	87.12	91.08
A3961WRA-24P	91.08	95.04

Unit: mm

A3961WV-R

3.96mm pitch 180° Wafer, Round PIN

Reference Informations:

- *Material:Pin:Brass/Tin over Nickel
Insulator:Nylon 66,UL94V-2
- *Mates with CJT A3961 or A3964 series Housing
- *Color:Natural

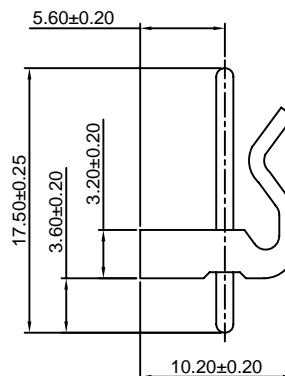
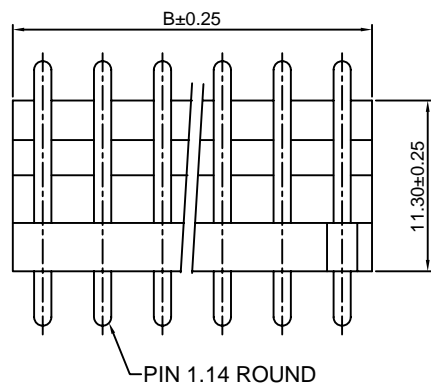
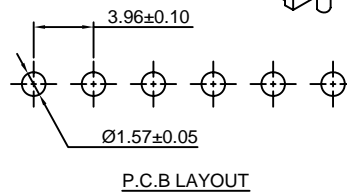
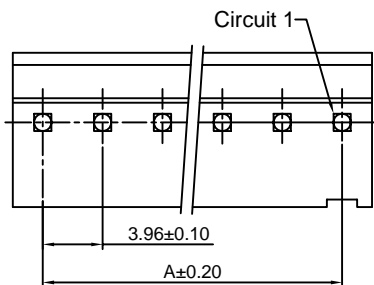
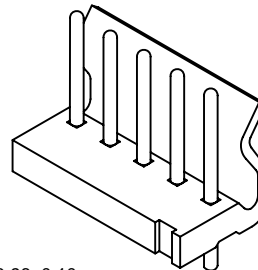

Ordering Information & Dimensions:

PART NO.	Dimensions	
	A	B
A3961WV-2P-R	3.96	7.92
A3961WV-3P-R	7.92	11.88
A3961WV-4P-R	11.88	15.84
A3961WV-5P-R	15.84	19.80
A3961WV-6P-R	19.80	23.76
A3961WV-7P-R	23.76	27.72
A3961WV-8P-R	27.72	31.68
A3961WV-9P-R	31.68	35.64
A3961WV-10P-R	35.64	39.60
A3961WV-11P-R	39.60	43.56
A3961WV-12P-R	43.56	47.52
A3961WV-13P-R	47.52	51.48
A3961WV-14P-R	51.48	55.44
A3961WV-15P-R	55.44	59.40
A3961WV-16P-R	59.40	63.36
A3961WV-17P-R	63.36	67.32
A3961WV-18P-R	67.32	71.28
A3961WV-19P-R	71.28	75.24
A3961WV-20P-R	75.24	79.20
A3961WV-21P-R	79.20	83.16
A3961WV-22P-R	83.16	87.12
A3961WV-23P-R	87.12	91.08
A3961WV-24P-R	91.08	95.04

Unit: mm



A3961 SERIES

3.96mm pitch wire to board connector

A3961WVA-R

3.96mm pitch 180° Wafer, Round PIN

Reference Informations:

- *Material:Pin:Brass/Tin over Nickel
Insulator:Nylon 66,UL94V-2
- *Mates with CJT A3961 or A3964 series Housing
- *Color:Natural

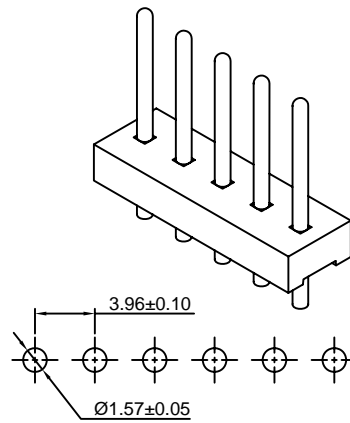
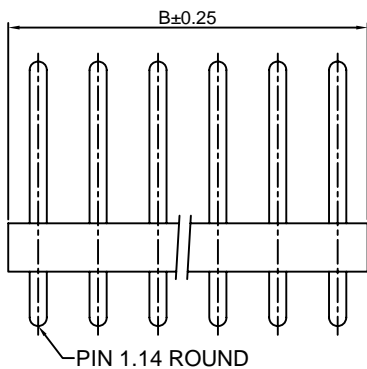
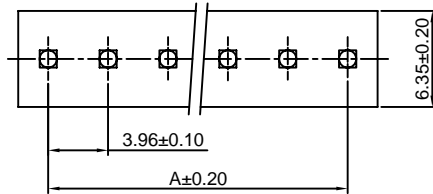

P.C.B LAYOUT

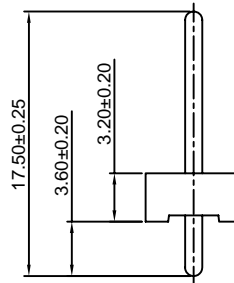

Ordering Information & Dimensions:

PART NO.	Dimensions	
	A	B
A3961WVA-2P-R	3.96	7.92
A3961WVA-3P-R	7.92	11.88
A3961WVA-4P-R	11.88	15.84
A3961WVA-5P-R	15.84	19.80
A3961WVA-6P-R	19.80	23.76
A3961WVA-7P-R	23.76	27.72
A3961WVA-8P-R	27.72	31.68
A3961WVA-9P-R	31.68	35.64
A3961WVA-10P-R	35.64	39.60
A3961WVA-11P-R	39.60	43.56
A3961WVA-12P-R	43.56	47.52
A3961WVA-13P-R	47.52	51.48
A3961WVA-14P-R	51.48	55.44
A3961WVA-15P-R	55.44	59.40
A3961WVA-16P-R	59.40	63.36
A3961WVA-17P-R	63.36	67.32
A3961WVA-18P-R	67.32	71.28
A3961WVA-19P-R	71.28	75.24
A3961WVA-20P-R	75.24	79.20
A3961WVA-21P-R	79.20	83.16
A3961WVA-22P-R	83.16	87.12
A3961WVA-23P-R	87.12	91.08
A3961WVA-24P-R	91.08	95.04

Unit: mm

A3961WV-A

7.92mm pitch 180° Wafer

Reference Informations:

- *Material:Pin:Brass/Tin over Nickel
Insulator:Nylon 66,UL94V-2
- *Mates with CJT A3961 or A3964 series Housing
- *Color:Natural

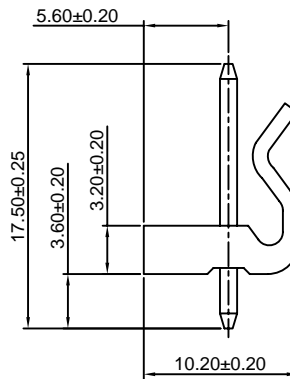
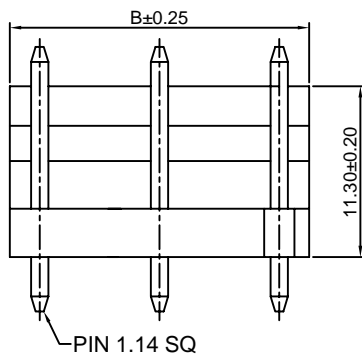
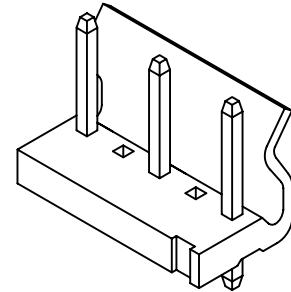
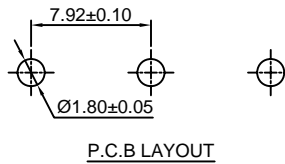
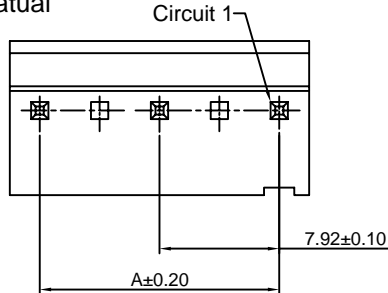

Ordering Information & Dimensions:

PART NO.	Dimensions	
	A	B
A3961WV-3P-A	7.92	11.88
A3961WV-5P-A	15.84	19.80
A3961WV-7P-A	23.76	27.72
A3961WV-9P-A	31.68	35.64
A3961WV-11P-A	39.60	43.56
A3961WV-13P-A	47.52	51.48
A3961WV-15P-A	55.44	59.40
A3961WV-17P-A	63.36	67.32
A3961WV-19P-A	71.28	75.24

Unit: mm

A3961WR-B-A

7.92mm pitch 90° Wafer

Reference Informations:

- *Material:Pin:Brass/Tin over Nickel
Insulator:Nylon 66,UL94V-2
- *Mates with CJT A3961 or A3964 series Housing
- *Color:Natural

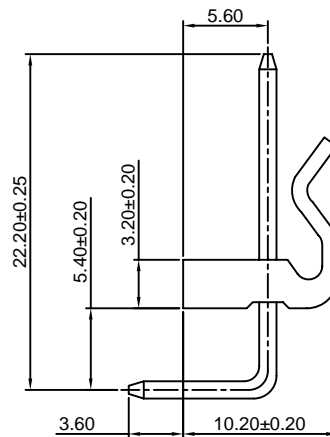
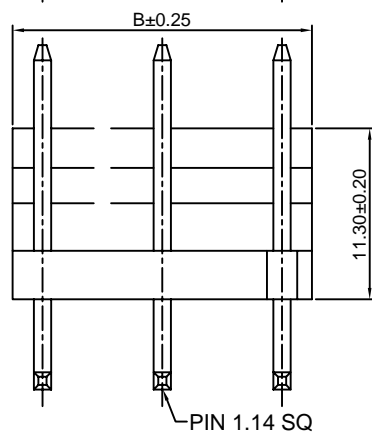
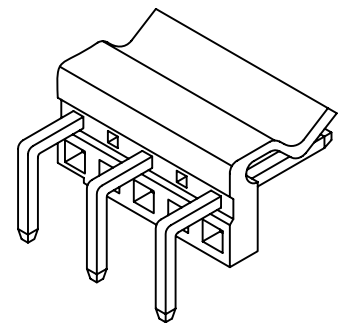
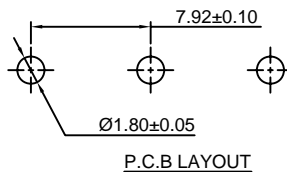
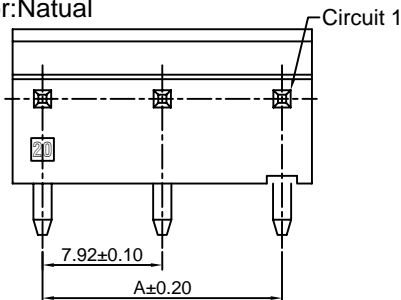

Ordering Information & Dimensions:

PART NO.	Dimensions	
	A	B
A3961WR-3P-B-A	7.92	11.88
A3961WR-5P-B-A	15.84	19.80
A3961WR-7P-B-A	23.76	27.72
A3961WR-9P-B-A	31.68	35.64
A3961WR-11P-B-A	39.60	43.56
A3961WR-13P-B-A	47.52	51.48
A3961WR-15P-B-A	55.44	59.40
A3961WR-17P-B-A	63.36	67.32
A3961WR-19P-B-A	71.28	75.24

Unit: mm

CJTconn A3961 SERIES

7.92mm pitch wire to board connector

A3961WVA-A

7.92mm pitch 180° Wafer

Reference Informations:

- *Material:Pin:Brass/Tin over Nickel
Insulator:Nylon 66,UL94V-2
- *Mates with CJT A3961 or A3964 series Housing
- *Color:Natural

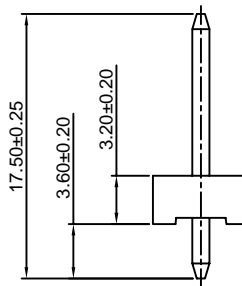
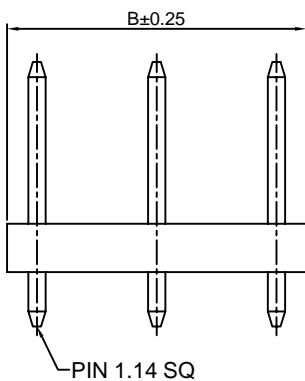
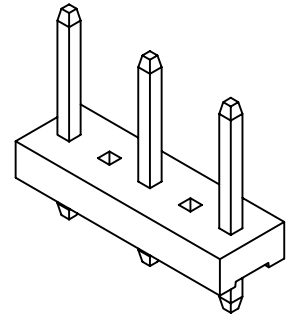
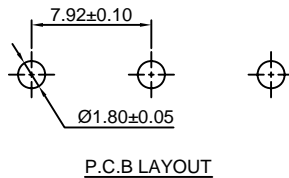
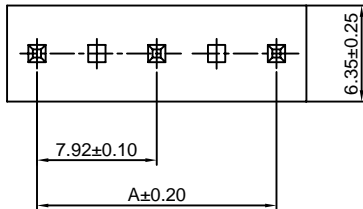

Ordering Information & Dimensions:

PART NO.	Dimensions	
	A	B
A3961WVA-3P-A	7.92	11.88
A3961WVA-5P-A	15.84	19.80
A3961WVA-7P-A	23.76	27.72
A3961WVA-9P-A	31.68	35.64
A3961WVA-11P-A	39.60	43.56
A3961WVA-13P-A	47.52	51.48
A3961WVA-15P-A	55.44	59.40
A3961WVA-17P-A	63.36	67.32
A3961WVA-19P-A	71.28	75.24

Unit: mm

A3961WRA-A

7.92mm pitch 90° Wafer

Reference Informations:

- *Material:Pin:Brass/Tin over Nickel
Insulator:Nylon 66,UL94V-2
- *Mates with CJT A3961 or A3964 series Housing
- *Color:Natural

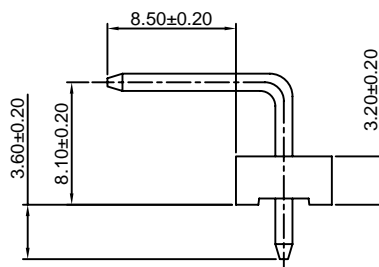
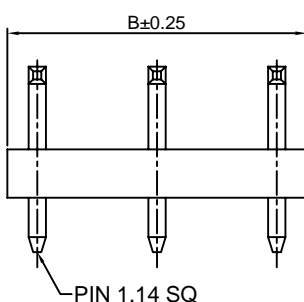
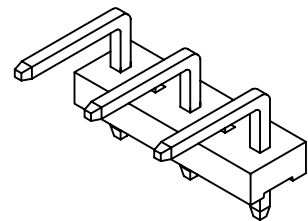
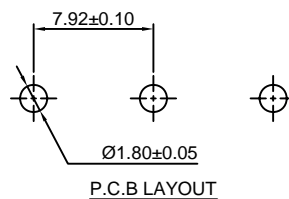
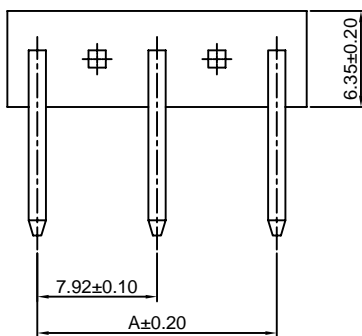

Ordering Information & Dimensions:

PART NO.	Dimensions	
	A	B
A3961WRA-3P-A	7.92	11.88
A3961WRA-5P-A	15.84	19.80
A3961WRA-7P-A	23.76	27.72
A3961WRA-9P-A	31.68	35.64
A3961WRA-11P-A	39.60	43.56
A3961WRA-13P-A	47.52	51.48
A3961WRA-15P-A	55.44	59.40
A3961WRA-17P-A	63.36	67.32
A3961WRA-19P-A	71.28	75.24

Unit: mm

A3961WV-R-A

7.92mm pitch 180° Wafer

Reference Informations:

- *Material:Pin:Brass/Tin over Nickel
Insulator:Nylon 66,UL94V-2
- *Mates with CJT A3961 or A3964 series Housing
- *Color:Natural

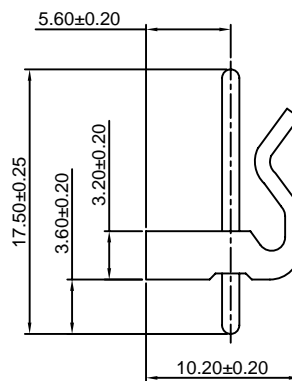
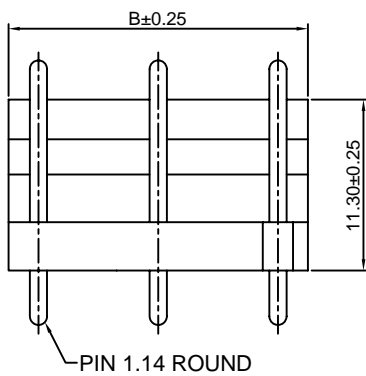
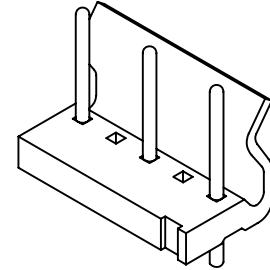
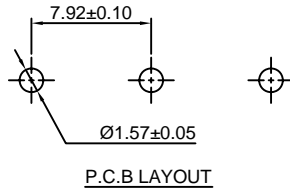
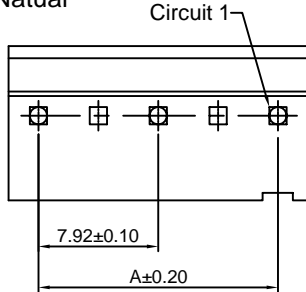

Ordering Information & Dimensions:

PART NO.	Dimensions	
	A	B
A3961WV-3P-R-A	7.92	11.88
A3961WV-5P-R-A	15.84	19.80
A3961WV-7P-R-A	23.76	27.72
A3961WV-9P-R-A	31.68	35.64
A3961WV-11P-R-A	39.60	43.56
A3961WV-13P-R-A	47.52	51.48
A3961WV-15P-R-A	55.44	59.40
A3961WV-17P-R-A	63.36	67.32
A3961WV-19P-R-A	71.28	75.24

Unit: mm

A3961WVA-R-A

7.92mm pitch 180° Wafer

Reference Informations:

- *Material:Pin:Brass/Tin over Nickel
Insulator:Nylon 66,UL94V-2
- *Mates with CJT A3961 or A3964 series Housing
- *Color:Natural

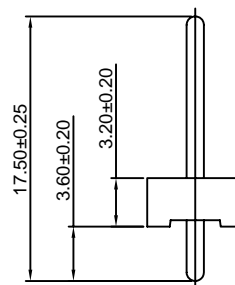
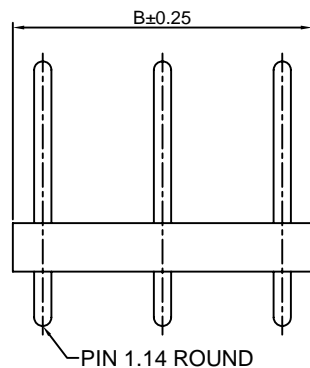
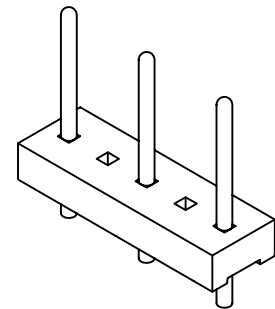
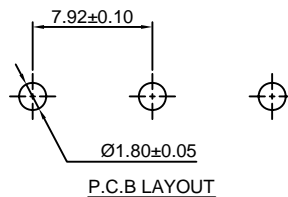
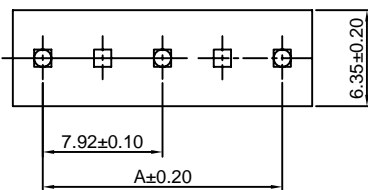

Ordering Information & Dimensions:

PART NO.	Dimensions	
	A	B
A3961WVA-3P-R-A	7.92	11.88
A3961WVA-5P-R-A	15.84	19.80
A3961WVA-7P-R-A	23.76	27.72
A3961WVA-9P-R-A	31.68	35.64
A3961WVA-11P-R-A	39.60	43.56
A3961WVA-13P-R-A	47.52	51.48
A3961WVA-15P-R-A	55.44	59.40
A3961WVA-17P-R-A	63.36	67.32
A3961WVA-19P-R-A	71.28	75.24

Unit: mm

A3961WVB

3.96mm pitch 180° Wafer

Reference Informations:

- *Material:Pin:Brass/Tin over Nickel
Insulator:Nylon 66,UL94V-0
- *Mates with CJT A3961 or A3964 series Housing
- *Color:White

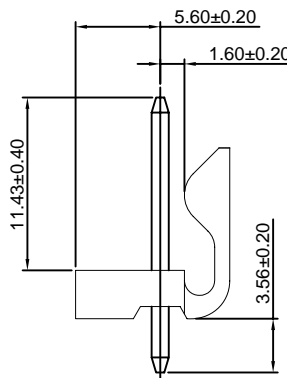
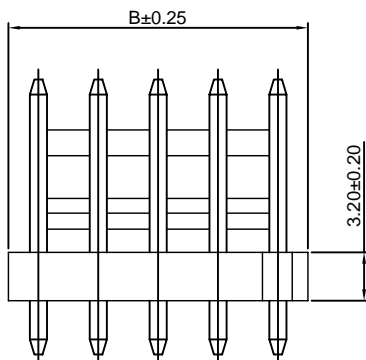
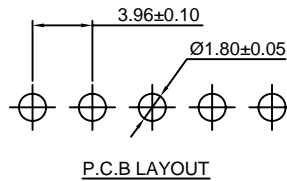
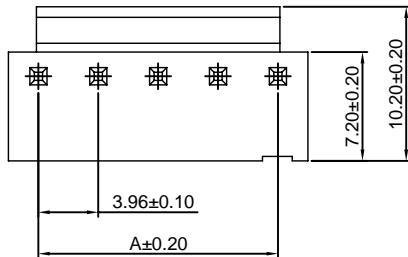

Ordering Information & Dimensions:

PART NO.	Dimensions	
	A	B
A3961WVB-2P	3.96	7.92
A3961WVB-3P	7.92	11.88
A3961WVB-4P	11.88	15.84
A3961WVB-5P	15.84	19.80
A3961WVB-6P	19.80	23.76
A3961WVB-7P	23.76	27.72
A3961WVB-8P	27.72	31.68
A3961WVB-9P	31.68	35.64
A3961WVB-10P	35.64	39.60
A3961WVB-11P	39.60	43.56
A3961WVB-12P	43.56	47.52
A3961WVB-13P	47.52	51.48
A3961WVB-14P	51.48	55.44
A3961WVB-15P	55.44	59.40
A3961WVB-16P	59.40	63.36
A3961WVB-17P	63.36	67.32
A3961WVB-18P	67.32	71.28
A3961WVB-19P	71.28	75.24
A3961WVB-20P	75.24	79.20

Unit: mm

A3961WVB-F

3.96mm pitch 180° Wafer

Reference Informations:

- *Material:Pin:Brass/Tin over Nickel
Insulator:Nylon 66,UL94V-0
- *Mates with CJT A3961 or A3964 series Housing
- *Color:White

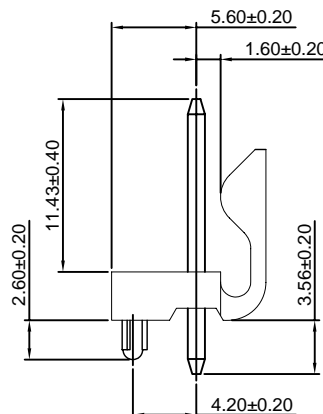
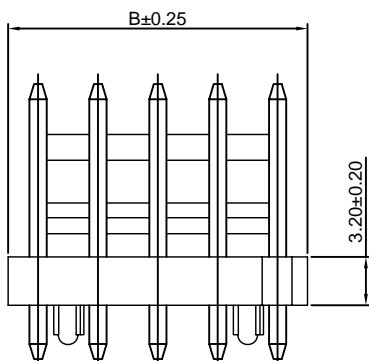
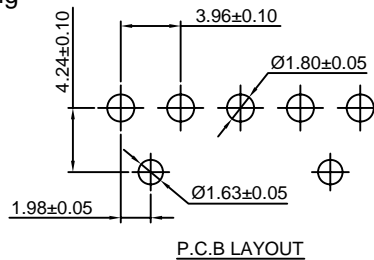
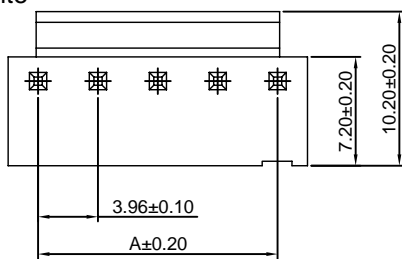

Ordering Information & Dimensions:

PART NO.	Dimensions	
	A	B
A3961WVB-F-2P	3.96	7.92
A3961WVB-F-3P	7.92	11.88
A3961WVB-F-4P	11.88	15.84
A3961WVB-F-5P	15.84	19.80
A3961WVB-F-6P	19.80	23.76
A3961WVB-F-7P	23.76	27.72
A3961WVB-F-8P	27.72	31.68
A3961WVB-F-9P	31.68	35.64
A3961WVB-F-10P	35.64	39.60
A3961WVB-F-11P	39.60	43.56
A3961WVB-F-12P	43.56	47.52
A3961WVB-F-13P	47.52	51.48
A3961WVB-F-14P	51.48	55.44
A3961WVB-F-15P	55.44	59.40
A3961WVB-F-16P	59.40	63.36
A3961WVB-F-17P	63.36	67.32
A3961WVB-F-18P	67.32	71.28
A3961WVB-F-19P	71.28	75.24
A3961WVB-F-20P	75.24	79.20

Unit: mm

CJTconn A3961 SERIES

7.92mm pitch wire to board connector

A3961WRB

3.96mm pitch 90° Wafer

Reference Informations:

- *Material:Pin:Brass/Tin over Nickel
Insulator:Nylon 66,UL94V-0
- *Mates with CJT A3961 or A3964 series Housing
- *Color:White

Ordering Information:

- A3961WRB-XP - **
1
2
- 1.Part No.
 - 2.Color:
(blank):White
BK:Black

Ordering Information & Dimensions:

PART NO.	Dimensions	
	A	B
A3961WRB-2P	3.96	7.92
A3961WRB-3P	7.92	11.88
A3961WRB-4P	11.88	15.84
A3961WRB-5P	15.84	19.80
A3961WRB-6P	19.80	23.76
A3961WRB-7P	23.76	27.72
A3961WRB-8P	27.72	31.68
A3961WRB-9P	31.68	35.64
A3961WRB-10P	35.64	39.60
A3961WRB-11P	39.60	43.56
A3961WRB-12P	43.56	47.52
A3961WRB-13P	47.52	51.48
A3961WRB-14P	51.48	55.44
A3961WRB-15P	55.44	59.40
A3961WRB-16P	59.40	63.36
A3961WRB-17P	63.36	67.32
A3961WRB-18P	67.32	71.28
A3961WRB-19P	71.28	75.24
A3961WRB-20P	75.24	79.20
A3961WRB-21P	79.20	83.16
A3961WRB-22P	83.16	87.12
A3961WRB-23P	87.12	91.08
A3961WRB-24P	91.08	95.04

Unit: mm

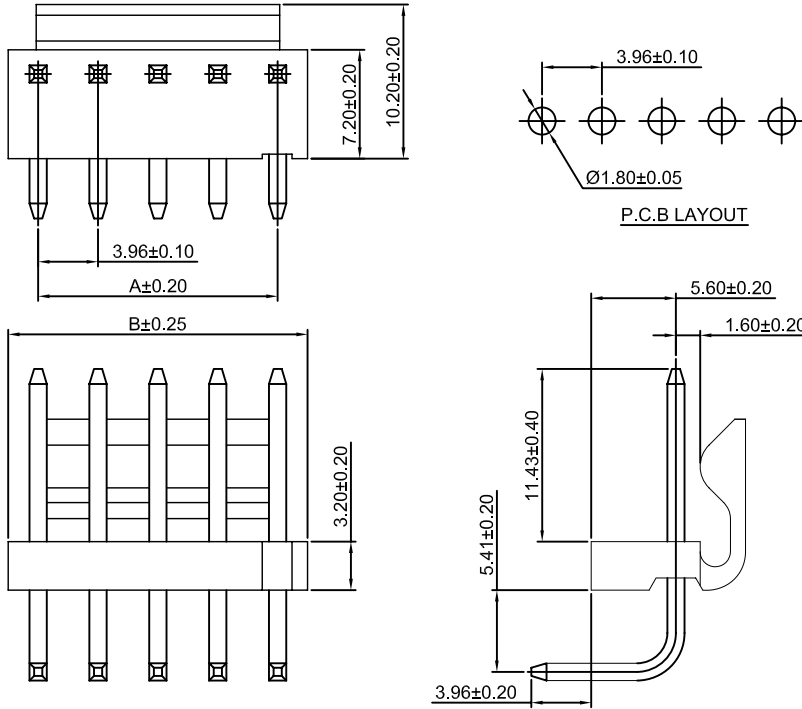

A3961WRB-F

3.96mm pitch 90° Wafer

Reference Informations:

- *Material:Pin:Brass/Tin over Nickel
Insulator:Nylon 66,UL94V-0
- *Mates with CJT A3961 or A3964 series Housing
- *Color:White

Ordering Information & Dimensions:

PART NO.	Dimensions	
	A	B
A3961WRB-F-2P	3.96	7.92
A3961WRB-F-3P	7.92	11.88
A3961WRB-F-4P	11.88	15.84
A3961WRB-F-5P	15.84	19.80
A3961WRB-F-6P	19.80	23.76
A3961WRB-F-7P	23.76	27.72
A3961WRB-F-8P	27.72	31.68
A3961WRB-F-9P	31.68	35.64
A3961WRB-F-10P	35.64	39.60
A3961WRB-F-11P	39.60	43.56
A3961WRB-F-12P	43.56	47.52
A3961WRB-F-13P	47.52	51.48
A3961WRB-F-14P	51.48	55.44
A3961WRB-F-15P	55.44	59.40
A3961WRB-F-16P	59.40	63.36
A3961WRB-F-17P	63.36	67.32
A3961WRB-F-18P	67.32	71.28
A3961WRB-F-19P	71.28	75.24
A3961WRB-F-20P	75.24	79.20
A3961WRB-F-21P	79.20	83.16
A3961WRB-F-22P	83.16	87.12
A3961WRB-F-23P	87.12	91.08
A3961WRB-F-24P	91.08	95.04

Unit: mm

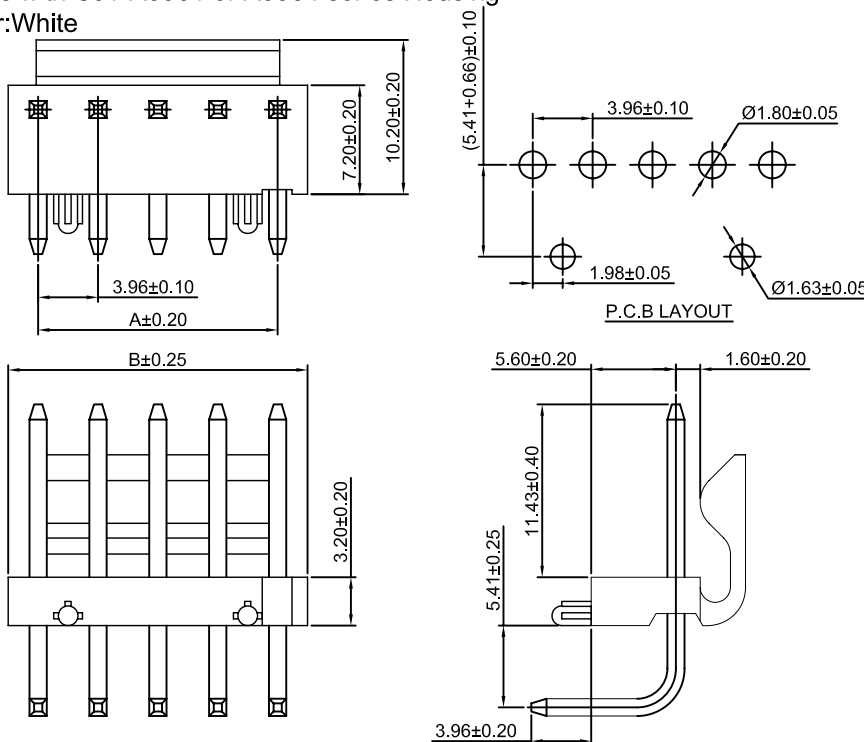

CJTconn A3961 SERIES

7.92mm pitch wire to board connector

A3961WRB-F-L

3.96mm pitch 90° Wafer

Reference Informations:

- *Material:Pin:Brass/Tin over Nickel
Insulator:Nylon 66,UL94V-0
- *Mates with CJT A3961 or A3964 series Housing
- *Color:White

Ordering Information & Dimensions:

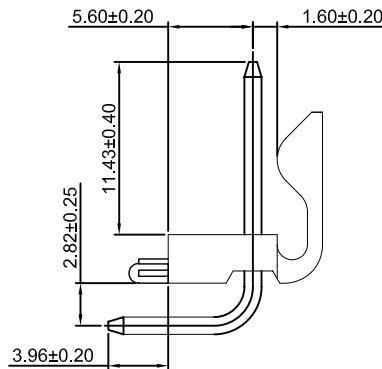
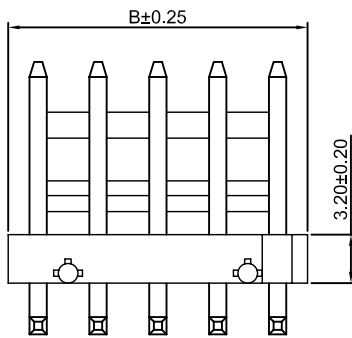
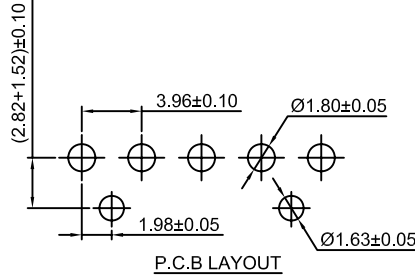
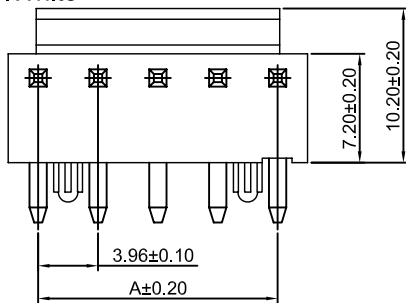

PART NO.	Dimensions	
	A	B
A3961WRB-F-L-2P	3.96	7.92
A3961WRB-F-L-3P	7.92	11.88
A3961WRB-F-L-4P	11.88	15.84
A3961WRB-F-L-5P	15.84	19.80
A3961WRB-F-L-6P	19.80	23.76
A3961WRB-F-L-7P	23.76	27.72
A3961WRB-F-L-8P	27.72	31.68
A3961WRB-F-L-9P	31.68	35.64
A3961WRB-F-L-10P	35.64	39.60
A3961WRB-F-L-11P	39.60	43.56
A3961WRB-F-L-12P	43.56	47.52
A3961WRB-F-L-13P	47.52	51.48
A3961WRB-F-L-14P	51.48	55.44
A3961WRB-F-L-15P	55.44	59.40
A3961WRB-F-L-16P	59.40	63.36
A3961WRB-F-L-17P	63.36	67.32
A3961WRB-F-L-18P	67.32	71.28
A3961WRB-F-L-19P	71.28	75.24
A3961WRB-F-L-20P	75.24	79.20
A3961WRB-F-L-21P	79.20	83.16
A3961WRB-F-L-22P	83.16	87.12
A3961WRB-F-L-23P	87.12	91.08
A3961WRB-F-L-24P	91.08	95.04

Unit: mm