

WH2508F

High sensitivity Hall-effect switch

[Http://www.sh-willsemi.com](http://www.sh-willsemi.com)

Descriptions

The WH2508F is a miniature micropower magnetic Hall effect switch IC with single output. The temperature compensation circuitry improves stability of magnetic switch points over the whole operating range. If the magnetic flux density perpendicular to the part marking surface is larger than operating point (BOP), the output will be turned on; if it is less than releasing point (BRP), the output will be turned off. The device operates in the omnipolar mode.

The WH2508F are available in TSOT23-3L packages. Standard products are Pb-free and Halogen free products.

Features

- Omnipolar Operation
- Supply voltage range 1.6V ~ 5.5V
- High Magnetic Sensitivity
Bop=36 Gauss Brp=25 Gauss (South)
Bop=-37 Gauss Brp=-26 Gauss (North)
- Average Supply Current <6.5 μA @VDD=3.3V (typical)
- 8KV ESD on Supply and Output Pins
- Operating Temperature -40 ~ +85 °C

Applications

- Cover switch in notebook PC/PAD
- Cell phones
- Level, proximity and position switches

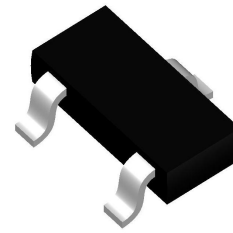

TSOT23-3L

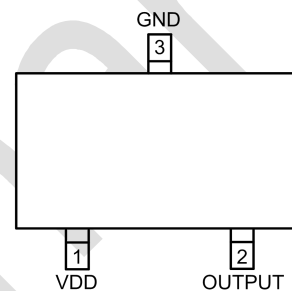

Pin Configuration (Top View)

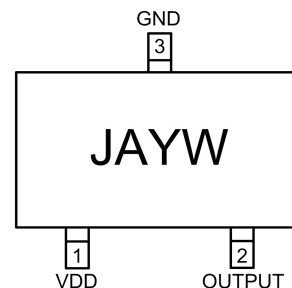

JA: Device Code
Y: YEAR Code
W: WEEK Code

Marking

Order Information

Device	Marking	Package	Shipping
WH2508F-3/TR	JAYW	TSOT-23-3L	3000/Reel&Tape

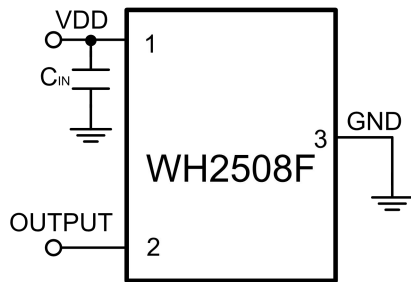
Typical Application

Pin Descriptions

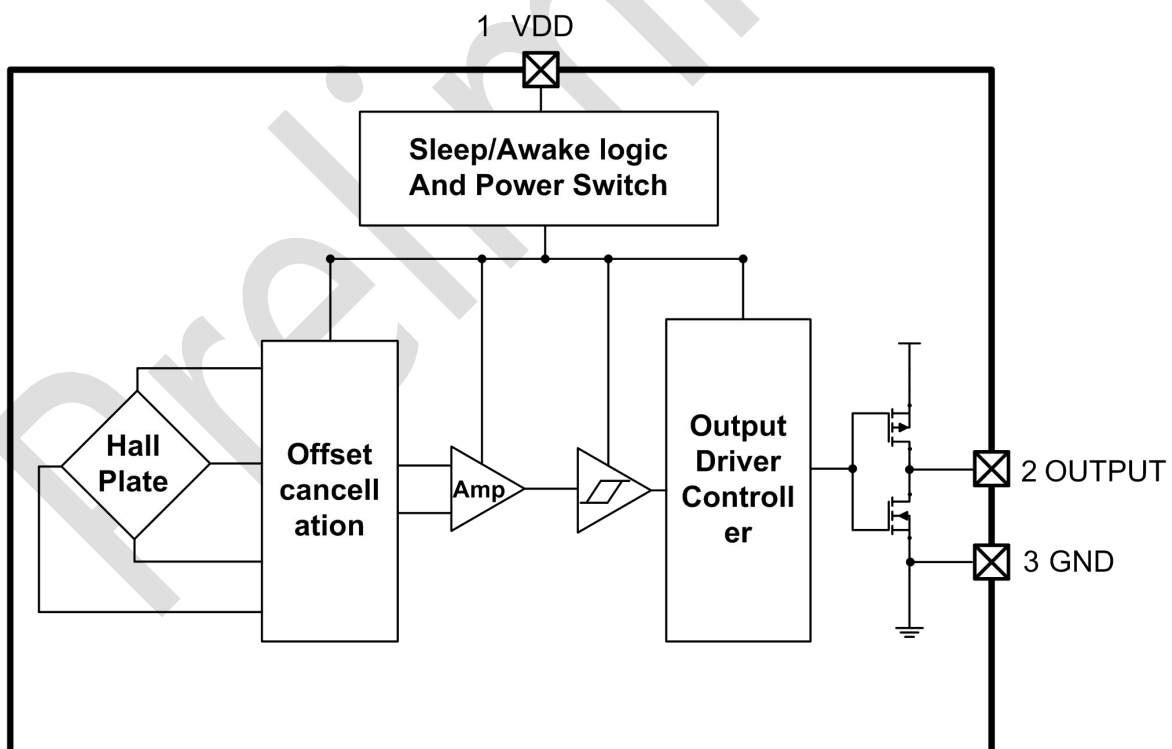
PIN	Symbol	Description
1	VDD	Power supply Input
2	OUTPUT	Output
3	GND	Ground

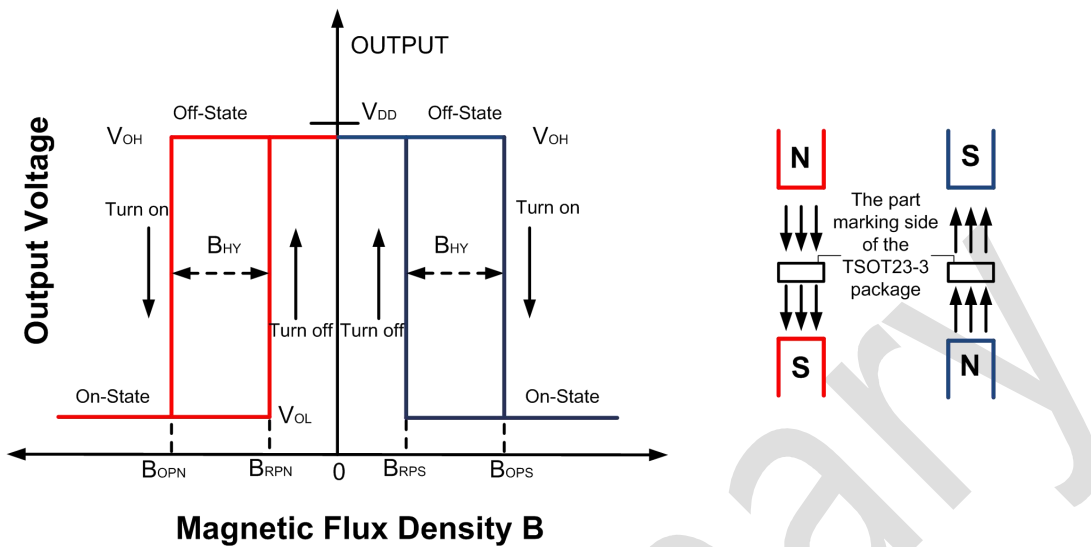
Block Diagram

Output Switching Characteristics

Absolute Maximum Ratings (@ $T_A=+25^{\circ}\text{C}$, unless otherwise specified)

Symbol	Parameter	Value	Unit
V_{DD}	Supply Voltage Dissipation	6	V
V_{DD_REV}	V_{IN} Range	-0.3	V
I_{OUTPUT}	Output Current	5	mA
B	Magnetic Flux Density	Unlimited	
P_D	Package Power Dissipation	TSOT23-3L	400 mW
T_{STG}	Storage Temperature Range	-50~+150	$^{\circ}\text{C}$
T_J	Maximum Junction Temperature	+150	$^{\circ}\text{C}$
ESD HBM	Human Body Model ESD Capability	8000	V

Note: Exceeding the absolute maximum ratings may cause permanent damage. Exposure to absolute-maximum rated conditions for extended periods may affect device reliability.

Recommended Operating Range (@ $T_A=+25^{\circ}\text{C}$, unless otherwise specified)

Symbol	Parameter	Conditions	Value	Unit
V_{DD}	Supply Voltage	Operating	1.6~5.5	V
T_A	Operating temperature Range	Operating	-40~85	$^{\circ}\text{C}$

Electronics Characteristics (@T_A=+25°C, V_{DD}=1.8V, unless otherwise specified)

Symbol	Parameter	Condition	Min.	Typ.	Max.	Unit
VDD	Supply Voltage	Operating	1.6	—	5.5	V
I _{DD(AVG)}	Average Supply Current	T _A =+25°C, V _{DD} =1.8V	—	3.35	—	μA
I _{DD(Awake)}	Awake Supply Current	T _A =+25°C, V _{DD} =1.8V	—	1.82	—	mA
I _{DD(Sleep)}	Sleep Supply Current	T _A =+25°C, V _{DD} =1.8V	—	0.96	—	μA
VOL	Output Low Voltage (On)	I _{OUT} =5mA	—	0.085	0.1	V
VOH	Output high Voltage (Off)	I _{OUT} =5mA	V _{DD} -0.1	V _{DD} -0.085	—	V
T _{AWAKE}	Awake Time	Operating	—	50	—	μs
T _{PERIOD}	Period	Operating	—	45	—	ms

Note: When the power is initially turned on, the operating VDD (1.6V to 3.6V) must be applied to guaranteed the output sampling. The output state is valid after the second operating cycle (typical 45ms).

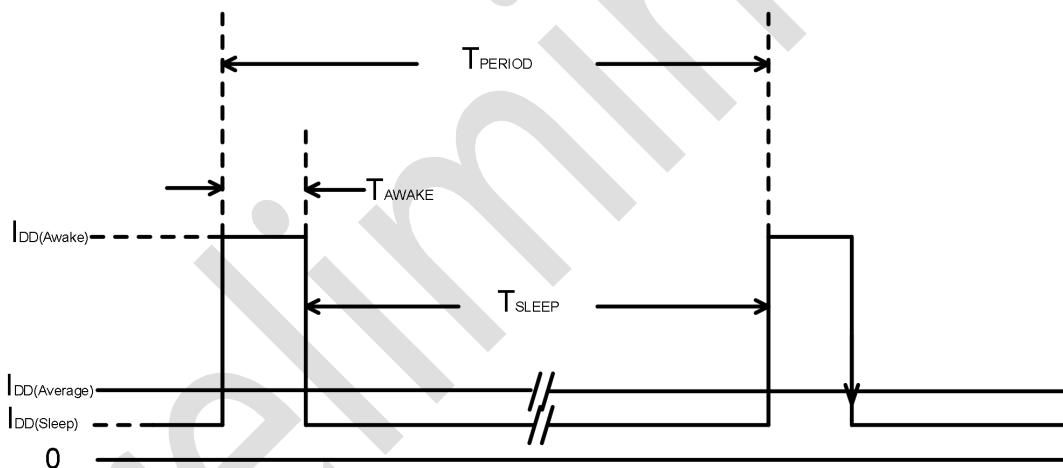

Magnetic Characteristics (T_A=25°C, V_{DD}=1.8V, unless otherwise noted)

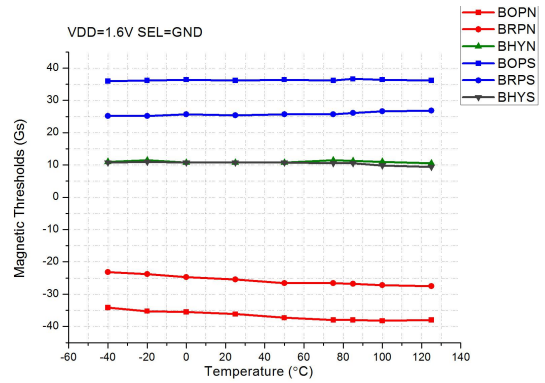
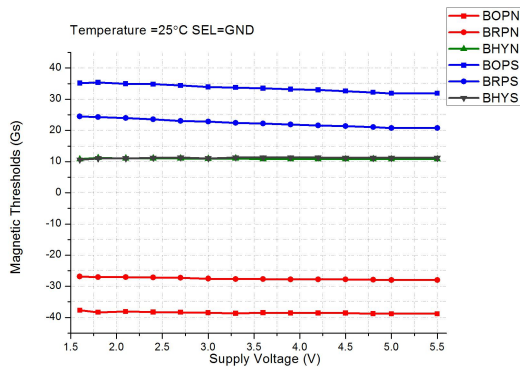
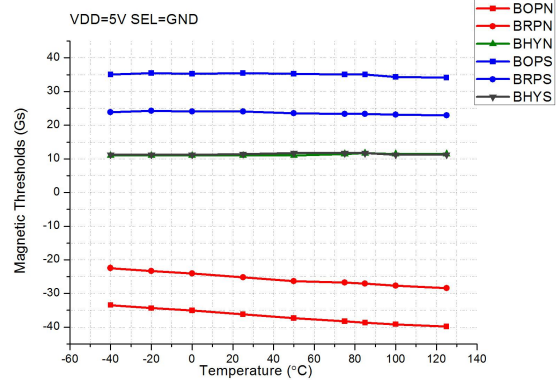
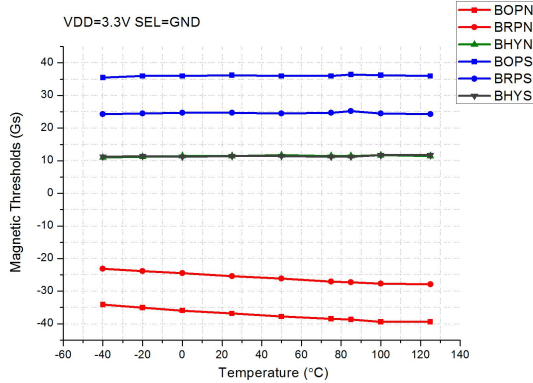
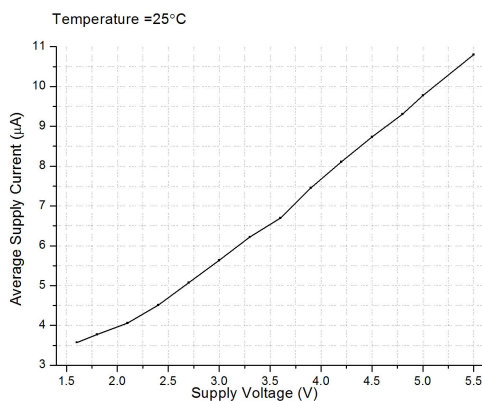
Symbol	Characteristics	Condition	Min.	Typ.	Max.	Unit
B _{OPN} (North Pole Part Marking Side)	Output Operation Point	T _A =+25°C, V _{DD} =1.8V	-44	-37	-32	Gauss
B _{OPS} (South Pole Part Marking Side)	Output Operation Point	T _A =+25°C, V _{DD} =1.8V	32	36	41	
B _{RPN} (North Pole Part Marking Side)	Output Release Point	T _A =+25°C, V _{DD} =1.8V	-34	-26	-23	
B _{RPS} (South Pole Part Marking Side)	Output Release Point	T _A =+25°C, V _{DD} =1.8V	21	25	30	
B _{HY} (B _{OPX} - B _{RPX})	Hysteresis		-	11	-	

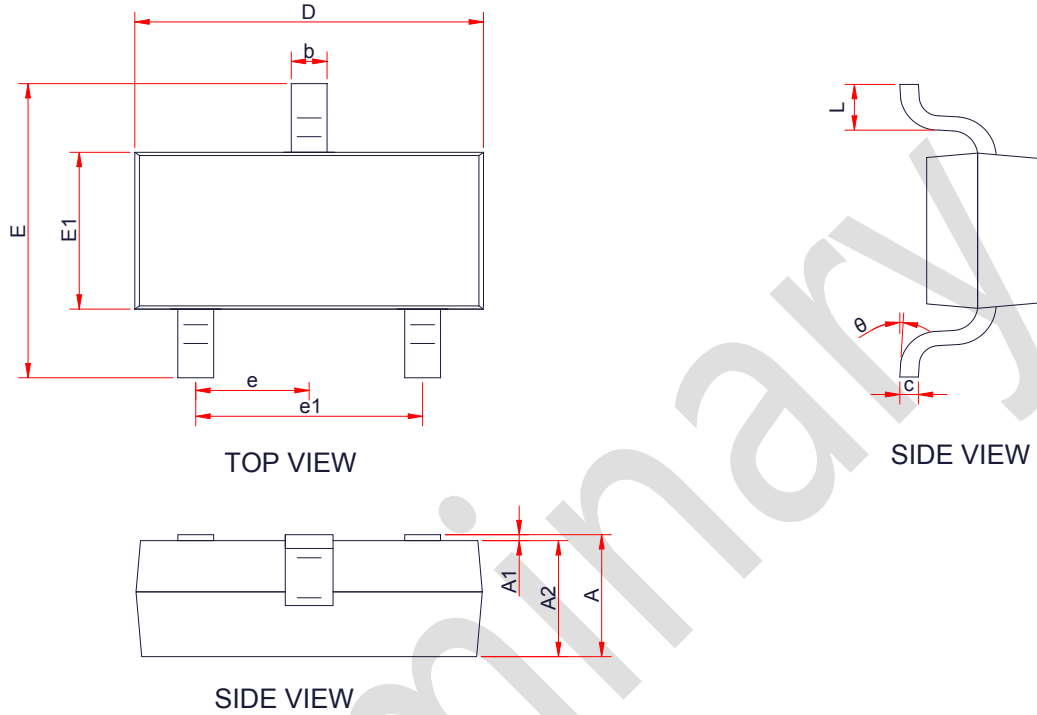
Performance Graphs

Magnetic Thresholds vs. Supply Voltage @T_A=25°C
Magnetic Thresholds vs T_A @VDD=1.6V

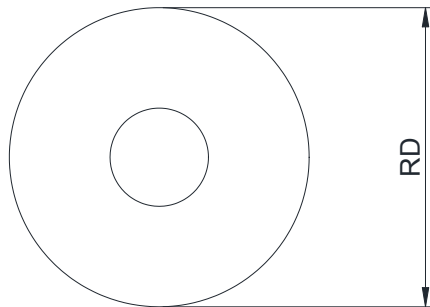
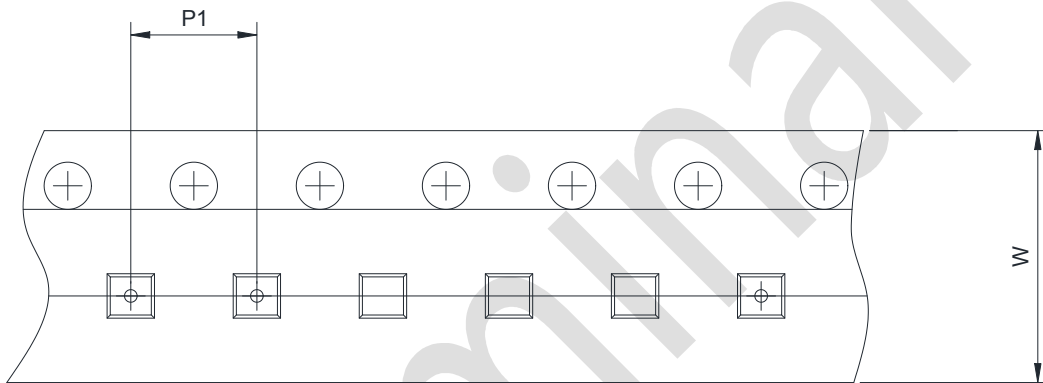
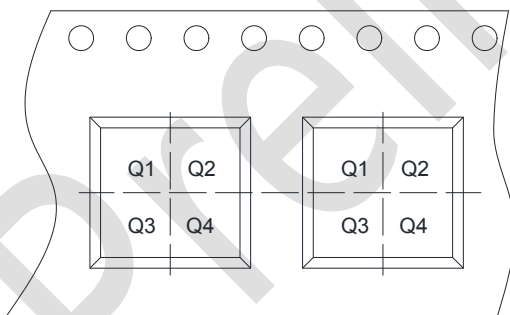
Magnetic Thresholds vs T_A @VDD=3.3V
Magnetic Thresholds vs T_A @VDD=5V

Current Consumption vs. T_A

PACKAGE OUTLINE DIMENSIONS
TSOT-23-3L

Symbol	Dimensions in Millimeters		
	Min.	Typ.	Max.
A	-	-	0.90
A1	0.00	-	0.10
A2	0.70	0.75	0.80
b	0.35	0.42	0.50
c	0.08	0.14	0.20
D	2.82	2.92	3.02
E	2.65	2.80	2.95
E1	1.60	1.65	1.70
e	0.95BSC		
e1	1.90BSC		
L	0.30	0.45	0.60
θ	0 °	-	8 °

TAPE AND REEL INFORMATION
Reel Dimensions

Tape Dimensions

Quadrant Assignments For PIN1 Orientation In Tape



 User Direction of Feed

RD	Reel Dimension	<input checked="" type="checkbox"/> 7inch	<input type="checkbox"/> 13inch
W	Overall width of the carrier tape	<input checked="" type="checkbox"/> 8mm	<input type="checkbox"/> 12mm <input type="checkbox"/> 16mm
P1	Pitch between successive cavity centers	<input type="checkbox"/> 2mm	<input checked="" type="checkbox"/> 4mm <input type="checkbox"/> 8mm
Pin1	Pin1 Quadrant	<input type="checkbox"/> Q1	<input type="checkbox"/> Q2 <input checked="" type="checkbox"/> Q3 <input type="checkbox"/> Q4