

Specifications

- Current rating:3A AC,DC
- Voltage rating:250V AC,DC
- Temperature range:-40°C~+105°C
- Contact resistance:10mΩMax.
- Insulation resistance:1000MΩMin.
- Withstanding voltage:800V AC/minute
- *Compliant with RoHS and REACH*
- *Meet the HF/Halogen Free,need to customize*
- *Contact CJT for details*

Standards

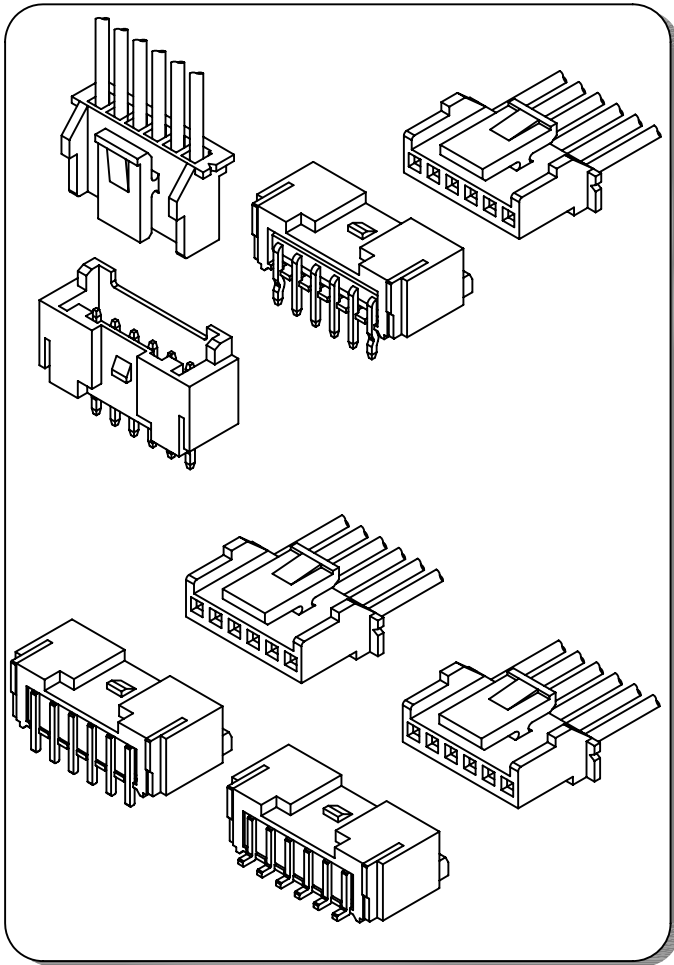

Assembly layout

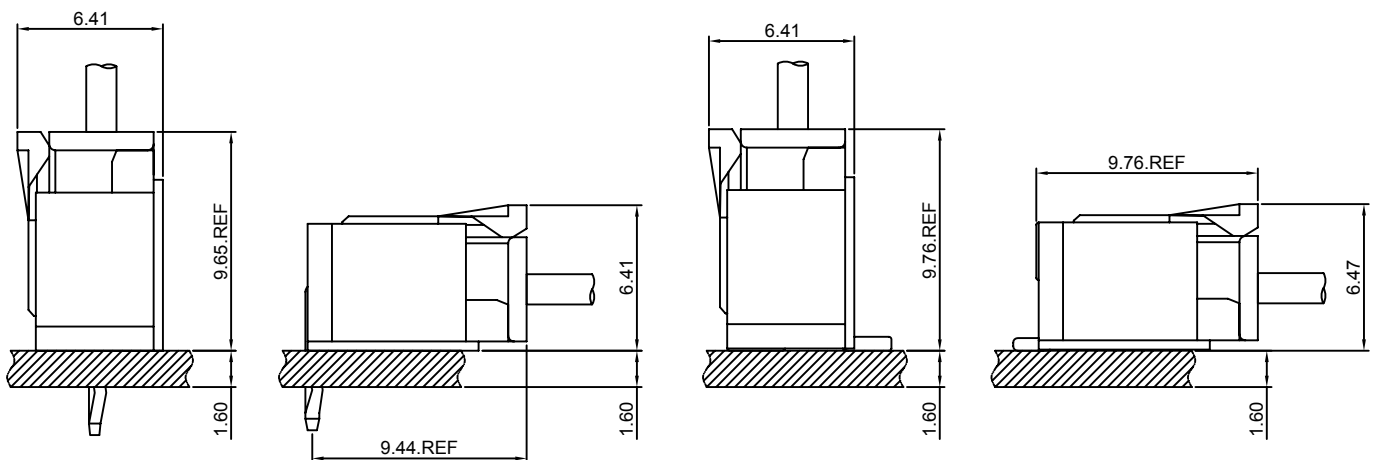



A2012 SERIES

2.00mm pitch wire to board connector

A2012-T-D

2.00mm pitch Crimp Terminal

Reference Informations:

*Used in CJT A2012HD-2xXP series Dual Row Housing

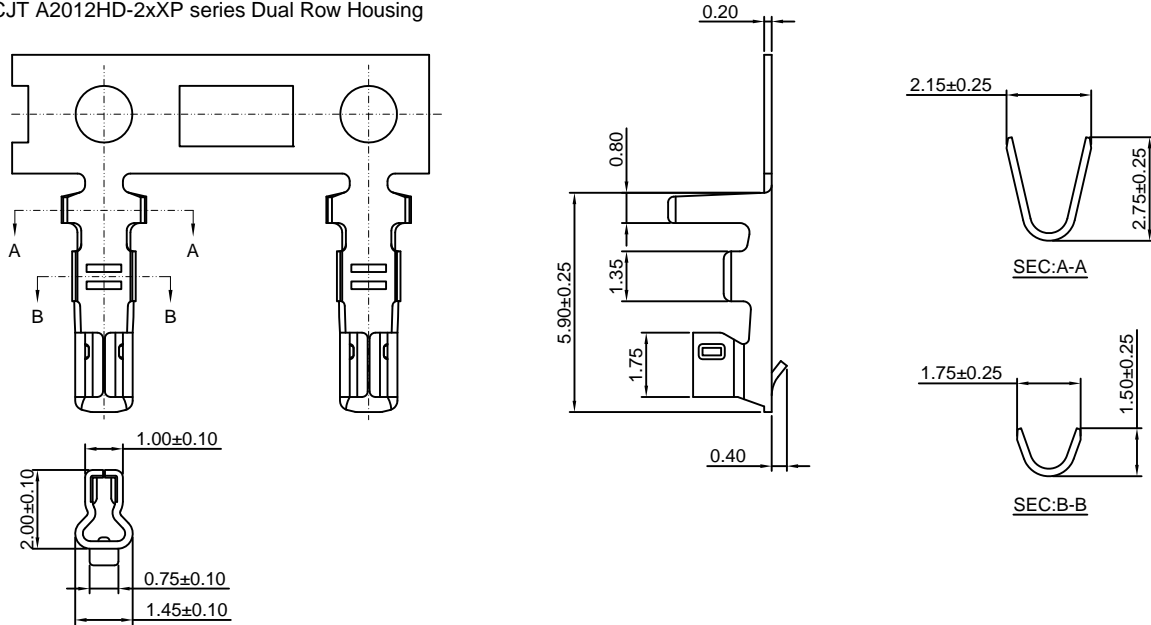

Ordering information & Specifications:

Unit:mm

Part NO.	Wire Range	Insulation O.D.	Material	Finish	Qty/reel
A2012-TP-D	AWG#24-#30	1.50mm(max)	Phosphor Bronze	Tin over Nickel	10,000 PCS
A2012-GP-D	AWG#24-#30	1.50mm(max)	Phosphor Bronze	Gold over Nickel	10,000 PCS

Optional Gold plating available but MOQ requested

A2012H-XP

2.00mm pitch Housing

Reference Informations:

*Material:Nylon 66,UL94V-0

*Suitable CJT A2006-T series Terminal

*Mates with CJT A2012WV,WR,WV-S,WR-S,WV-F-XP, A2012WVA,WRA,WVA-F,WRA-F-XP series Wafer

*Color:White

Ordering Information:

A2012H-XP - *** - **
1 2 3

1.Part No.

2.Material:

(Blank):Nylon 66,UL94V-0

GWT:Nylon 66,UL94V-0,GWT 750 °C

3.Color:

(Blank):White

BK:Black

RD:Red

BL:Blue

GN:Green

OR:Orange

BR:Brown

VI:Violet

PK:Pink

YL:Yellow

LY:Lemon yellow

VY:Vivid yellow

LE:Light blue

GY:Gray

TR:Tomato red

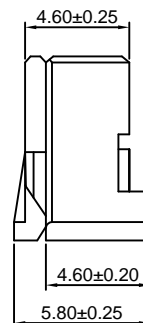
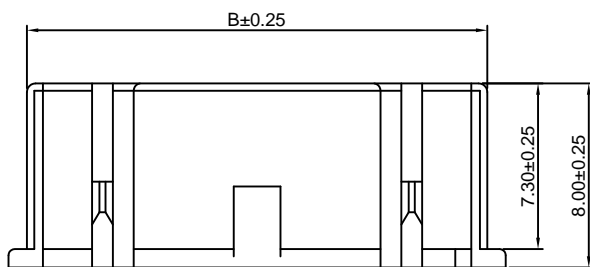
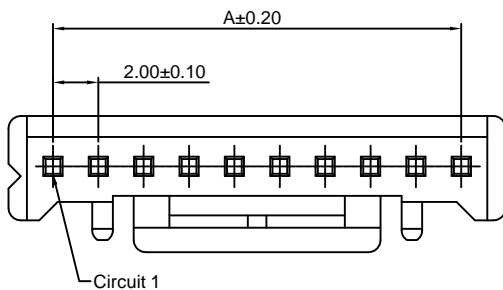
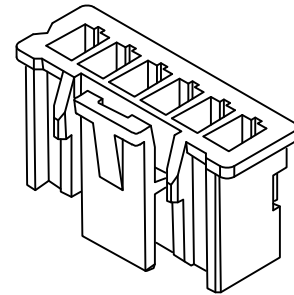

Ordering Information & Dimensions:

PART NO.	Dimensions	
	A	B
2P	2.00	4.30
3P	4.00	6.30
4P	6.00	8.30
5P	8.00	10.30
6P	10.00	12.30
7P	12.00	14.30
8P	14.00	16.30
9P	16.00	18.30
10P	18.00	20.30
11P	20.00	22.30
12P	22.00	24.30
13P	24.00	26.30
14P	26.00	28.30
15P	28.00	30.30
16P	30.00	32.30

Unit: mm

CJT_{conn} A2012 SERIES

2.00mm pitch wire to board connector

A2012HD-2xXP

2.00mm pitch Dual Row Housing

Reference Informations:

- *Material:Nylon 66,UL94V-0
- *Suitable CJT A2012-T-D series Terminal
- *Mates with CJT A2012WV,WV-F,WR-F-2xXP series Dual Row Wafer
- *Color:White

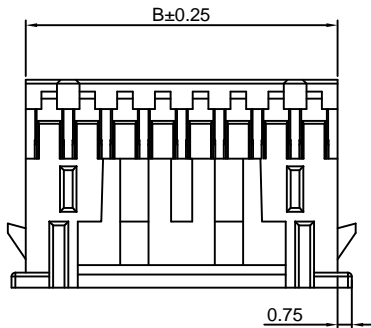
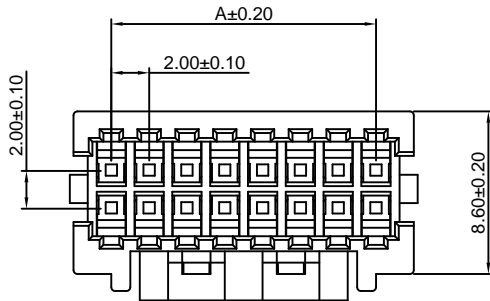

Ordering Information:

- A2012HD-2xXP - ***
 1 2
 1.Part No.
 2.Material:
 (Blank):Nylon 66,UL94V-0
 GWT:Nylon 66,UL94V-0,GWT 750 °C

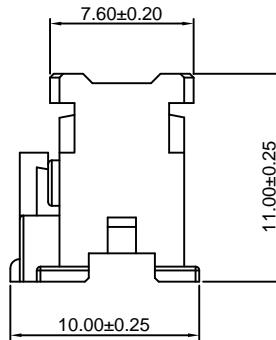

Ordering Information & Dimensions:

PART NO.	Dimensions	
	A	B
2x2P	2.00	5.00
2x3P	4.00	7.00
2x4P	6.00	9.00
2x5P	8.00	10.50
2x6P	10.00	12.50
2x7P	12.00	14.50
2x8P	14.00	16.50
2x9P	16.00	18.50
2x10P	18.00	20.50
2x11P	20.00	22.50
2x12P	22.00	24.50
2x13P	24.00	26.50
2x14P	26.00	28.50
2x15P	28.00	30.50
2x16P	30.00	32.50
2x17P	32.00	34.50
2x18P	34.00	36.50
2x19P	36.00	38.50
2x20P	38.00	40.50

Unit: mm

A2012WV-XP

2.00mm pitch 180° Wafer

Reference Informations:

- *Material:Pin:Brass/Tin over Nickel
Insulator:Nylon 6T,UL94V-0
- *Mates with CJT A2012H-XP series Housing
- *Color:Ivory

Ordering Information:

- A2012WV-XP - *** - **
 1 2 3
 1.Part No.
 2.Material:
 (Blank):Nylon 6T,UL94V-0
 GWT:Nylon 6T,UL94V-0,GWT 750 °C
 3.Finish:
 (blank):Tin over Nickel
 G:Gold over Nickel

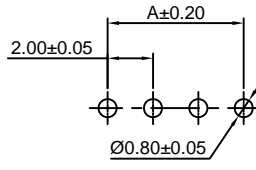
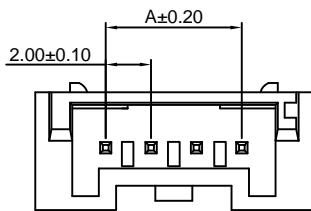

P.C.B LAYOUT

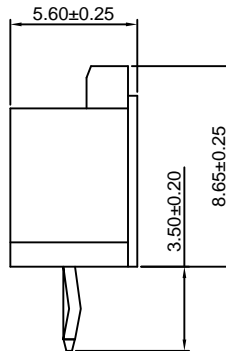
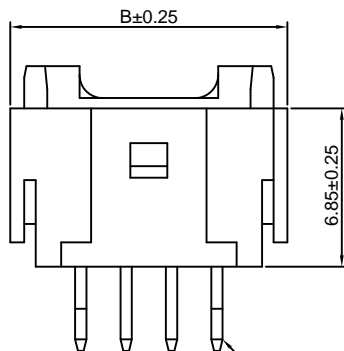

PIN 0.50 SQ
Circuit 1

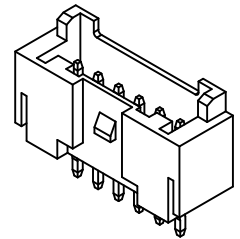

Ordering Information & Dimensions:

PART NO.	Dimensions	
	A	B
2P	2.00	8.00
3P	4.00	10.00
4P	6.00	12.00
5P	8.00	14.00
6P	10.00	16.00
7P	12.00	18.00
8P	14.00	20.00
9P	16.00	22.00
10P	18.00	24.00
11P	20.00	26.00
12P	22.00	28.00
13P	24.00	30.00
14P	26.00	32.00
15P	28.00	34.00
16P	30.00	36.00

Unit: mm

A2012WR-XP

2.00mm pitch 90° Wafer

Reference Informations:

- *Material:Pin:Brass/Tin over Nickel
Insulator:Nylon 6T,UL94V-0
- *Mates with CJT A2012H-XP series Housing
- *Color:Ivory

Ordering Information:

- A2012WR-XP - *** - **
 1 2 3
- 1.Part No.
 - 2.Material:
(Blank):Nylon 6T,UL94V-0
GWT:Nylon 6T,UL94V-0,GWT 750 °C
 - 3.Finish:
(blank):Tin over Nickel
G:Gold over Nickel

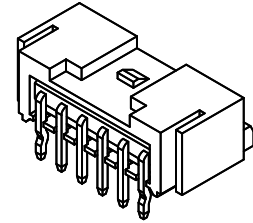
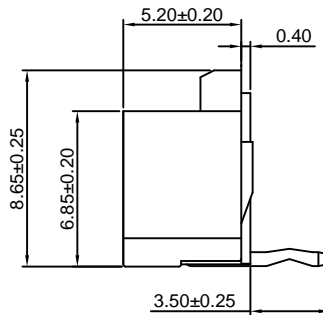
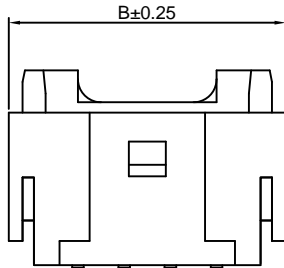
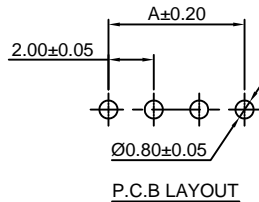
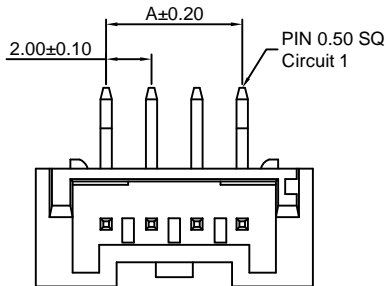

Ordering Information & Dimensions:

PART NO.	Dimensions	
	A	B
2P	2.00	8.00
3P	4.00	10.00
4P	6.00	12.00
5P	8.00	14.00
6P	10.00	16.00
7P	12.00	18.00
8P	14.00	20.00
9P	16.00	22.00
10P	18.00	24.00
11P	20.00	26.00
12P	22.00	28.00
13P	24.00	30.00
14P	26.00	32.00
15P	28.00	34.00
16P	30.00	36.00

Unit: mm

A2012WV-S-XP

2.00mm pitch 180° Wafer-SMT TYPE

Reference Informations:

- *Material:Pin:Brass/Tin over Nickel
Insulator:Nylon 6T,UL94V-0
- *Mates with CJT A2012H-XP series Housing
- *Color:Ivory

Ordering Information:

- A2012WV-S-XP - *** - **
 1 2 3
- 1.Part No.
 - 2.Material:
(Blank):Nylon 6T,UL94V-0
GWT:Nylon 6T,UL94V-0,GWT 750 °C
 - 3.Finish:
(blank):Tin over Nickel
G:Gold over Nickel

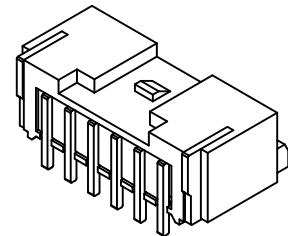
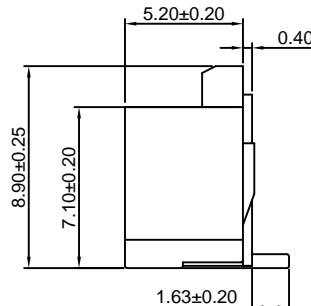
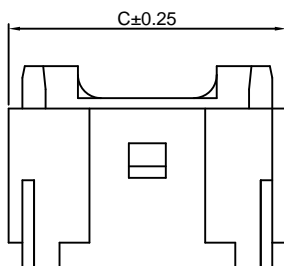
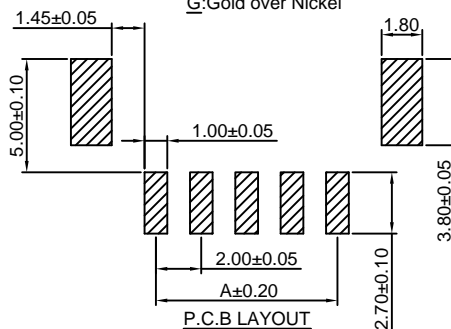
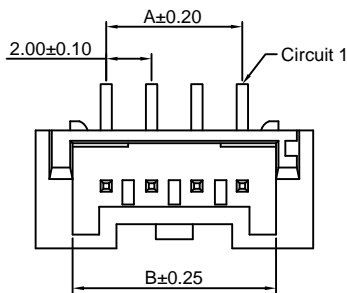

Ordering Information & Dimensions:

PART NO.	Dimensions		
	A	B	C
2P	2.00	4.50	8.00
3P	4.00	6.50	10.00
4P	6.00	8.50	12.00
5P	8.00	10.50	14.00
6P	10.00	12.50	16.00
7P	12.00	14.50	18.00
8P	14.00	16.50	20.00
9P	16.00	18.50	22.00
10P	18.00	20.50	24.00
11P	20.00	22.50	26.00
12P	22.00	24.50	28.00
13P	24.00	26.50	30.00
14P	26.00	28.50	32.00
15P	28.00	30.50	34.00
16P	30.00	32.50	36.00

Unit: mm

A2012WR-S-XP

2.00mm pitch 90° Wafer-SMT TYPE

Reference Informations:

- *Material:Pin:Brass/Tin over Nickel
Insulator:Nylon 6T,UL94V-0
- *Mates with CJT A2012H-XP series Housing
- *Color:Ivory

Ordering Information:
A2012WR-S-XP - *** - **
1 2 3
1.Part No.
2.Material:
(Blank):Nylon 6T,UL94V-0
GWT:Nylon 6T,UL94V-0,GWT 750 °C
3.Finish:
(blank):Tin over Nickel
G:Gold over Nickel

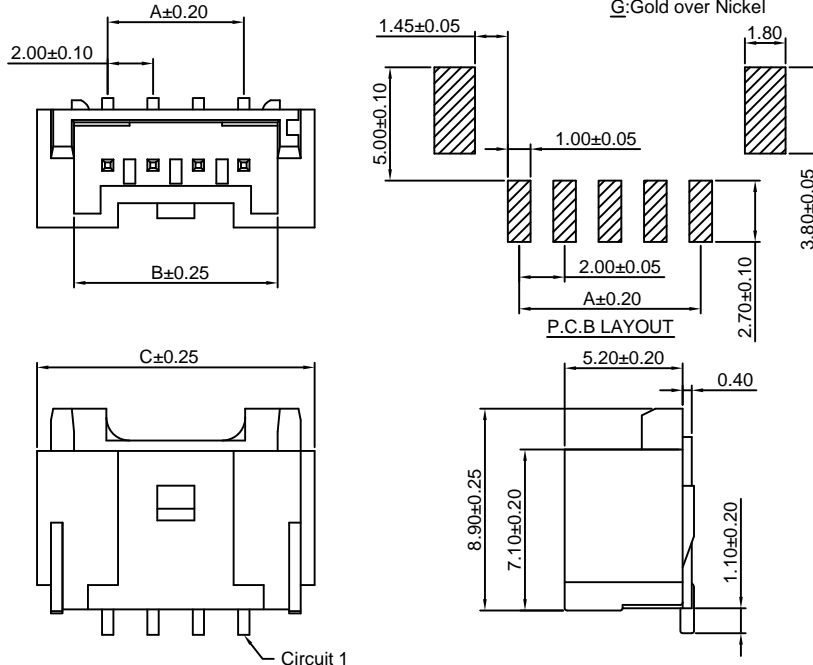
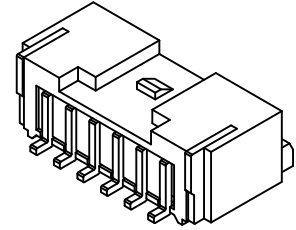

Ordering Information & Dimensions:

PART NO.	Dimensions		
	A	B	C
2P	2.00	4.50	8.00
3P	4.00	6.50	10.00
4P	6.00	8.50	12.00
5P	8.00	10.50	14.00
6P	10.00	12.50	16.00
7P	12.00	14.50	18.00
8P	14.00	16.50	20.00
9P	16.00	18.50	22.00
10P	18.00	20.50	24.00
11P	20.00	22.50	26.00
12P	22.00	24.50	28.00
13P	24.00	26.50	30.00
14P	26.00	28.50	32.00
15P	28.00	30.50	34.00
16P	30.00	32.50	36.00

Unit: mm

A2012WV-F-XP

2.00mm pitch 180° Wafer

Reference Informations:

- *Material:Pin:Brass/Tin over Nickel
Insulator:Nylon 66,UL94V-0
- *Mates with CJT A2012H-XP series Housing
- *Color:Ivory

Ordering Information:
A2012WV-F-XP - *** - **
1 2 3
1.Part No.
2.Material:
(Blank):Nylon 66,UL94V-0
GWT:Nylon 66,UL94V-0,GWT 750 °C
3.Finish:
(blank):Tin over Nickel
G:Gold over Nickel

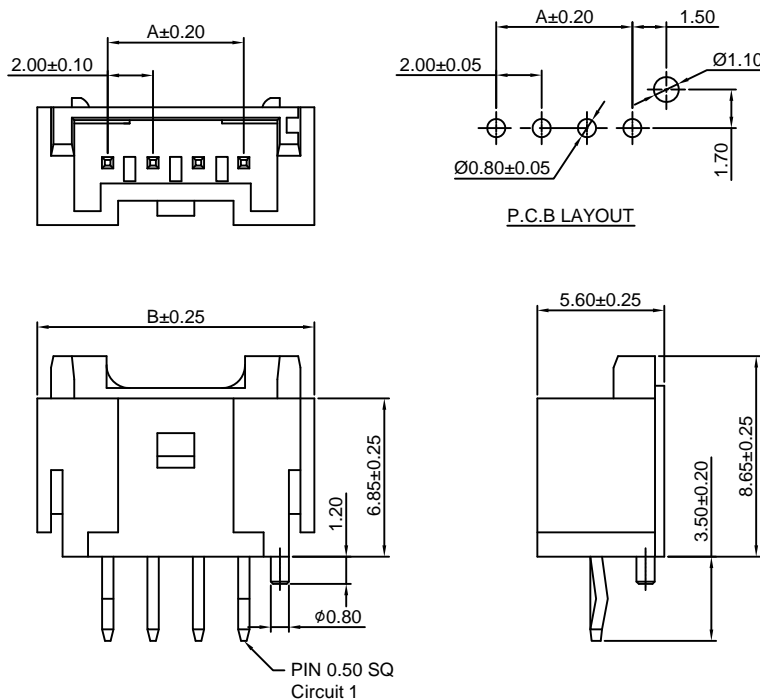

Ordering Information & Dimensions:

PART NO.	Dimensions	
	A	B
2P	2.00	8.00
3P	4.00	10.00
4P	6.00	12.00
5P	8.00	14.00
6P	10.00	16.00
7P	12.00	18.00
8P	14.00	20.00
9P	16.00	22.00
10P	18.00	24.00
11P	20.00	26.00
12P	22.00	28.00
13P	24.00	30.00
14P	26.00	32.00
15P	28.00	34.00
16P	30.00	36.00

Unit: mm



A2012 SERIES

2.00mm pitch wire to board connector

A2012WVA-XP

2.00mm pitch 180° Wafer

Reference Informations:

- *Material:Pin:Brass/Tin over Nickel
Insulator:Nylon 66,UL94V-0
- *Mates with CJT A2012H-XP series Housing
- *Color:White

Ordering Information:

A2012WVA-XP - ^{***}/₁ - ^{**}/₂ - ^{**}/₃ - ^{**}/₄

- 1.Part No.
- 2.Material:
(Blank):Nylon 66,UL94V-0
GWT:Nylon 66,UL94V-0,GWT 750 °C
- 3.Color:
(Blank):White
BK:Black PK:Pink
RD:Red YL:Yellow
BL:Blue LY:Lemon yellow
GN:Green VY:Vivid yellow
OR:Orange LE:Light blue
BR:Brown GY:Gray
VI:Violet TR:Tomato red
- 4.Finish:
(blank):Tin over Nickel
G:Gold over Nickel

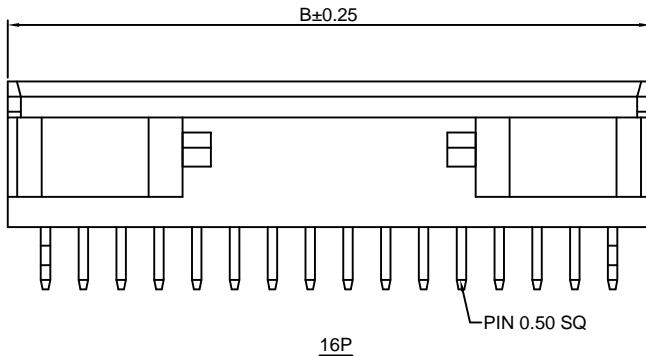
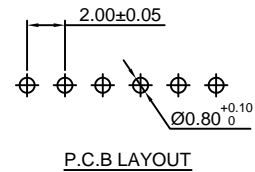
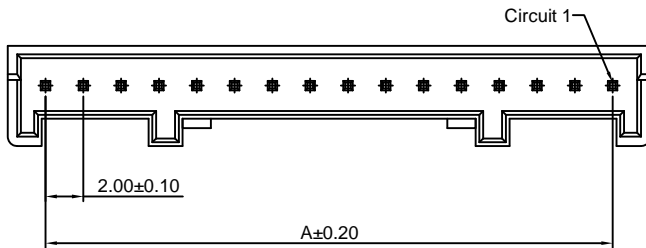
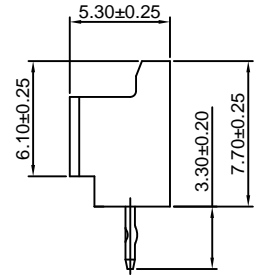
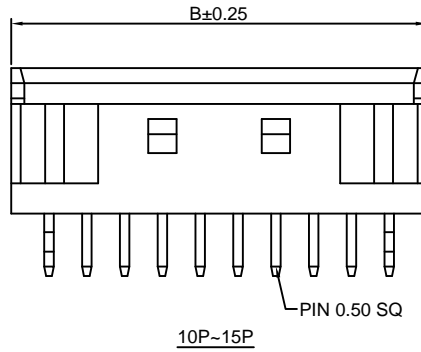
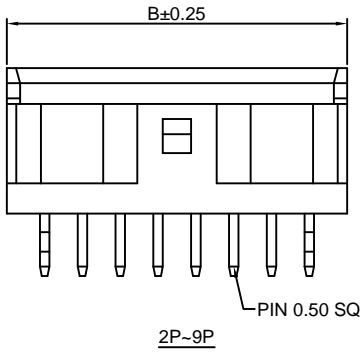
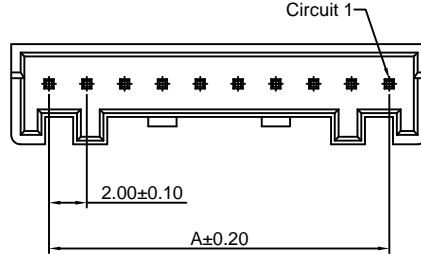
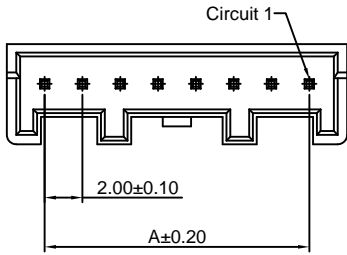

Ordering Information & Dimensions:

PART NO.	Dimensions	
	A	B
2P	2.00	6.00
3P	4.00	8.00
4P	6.00	10.00
5P	8.00	12.00
6P	10.00	14.00
7P	12.00	16.00
8P	14.00	18.00
9P	16.00	20.00
10P	18.00	22.00
11P	20.00	24.00
12P	22.00	26.00
13P	24.00	28.00
14P	26.00	30.00
15P	28.00	32.00
16P	30.00	34.00

Unit: mm



A2012 SERIES

2.00mm pitch wire to board connector

A2012WRA-XP

2.00mm pitch 90° Wafer

Reference Informations:

- *Material:Pin:Brass/Tin over Nickel
Insulator:Nylon 66,UL94V-0
- *Mates with CJT A2012H-XP series Housing
- *Color:White

Ordering Information:

A2012WRA-XP - *** - ** - **
1 2 3 4

- 1.Part No.
- 2.Material:
(Blank):Nylon 66,UL94V-0
GWT:Nylon 66,UL94V-0,GWT 750 °C
- 3.Color:
(Blank):White
BK:Black PK:Pink
RD:Red YL:Yellow
BL:Blue LY:Lemon yellow
GN:Green VY:Vivid yellow
OR:Orange LE:Light blue
BR:Brown GY:Gray
VI:Violet TR:Tomato red
- 4.Finish:
(blank):Tin over Nickel
G:Gold over Nickel

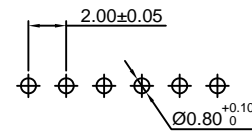
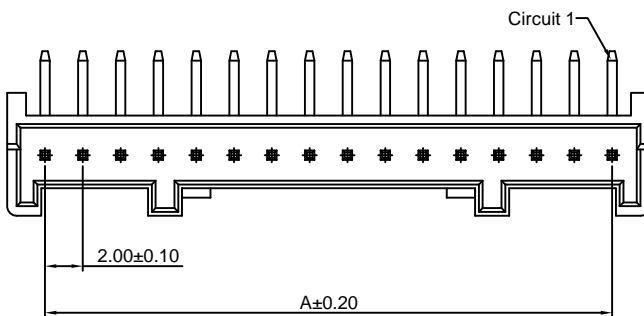
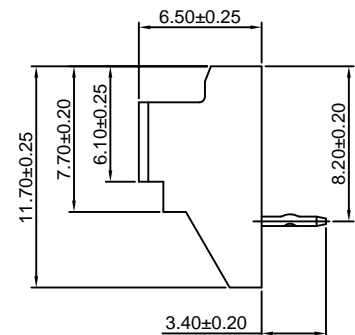
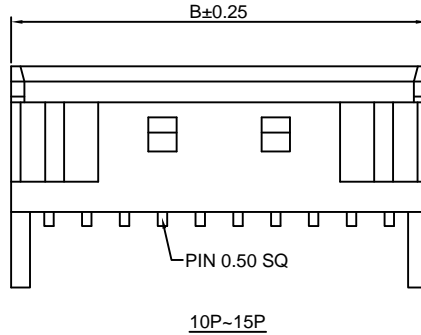
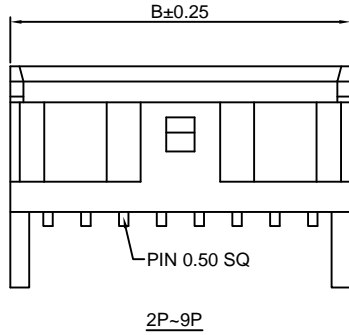
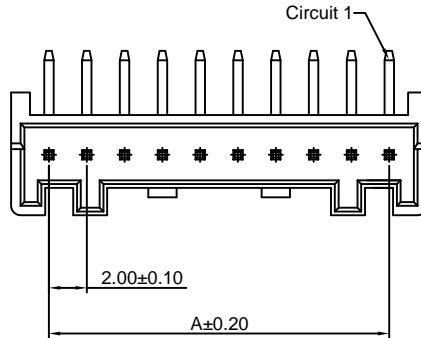
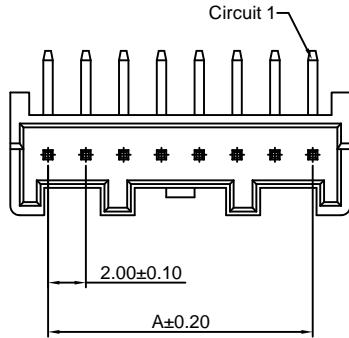

P.C.B LAYOUT

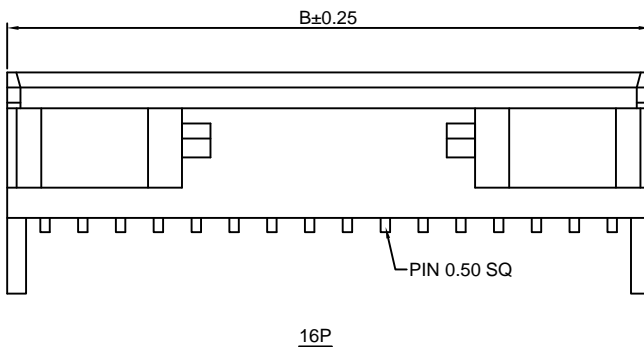

Ordering Information & Dimensions:

PART NO.	Dimensions	
	A	B
2P	2.00	6.00
3P	4.00	8.00
4P	6.00	10.00
5P	8.00	12.00
6P	10.00	14.00
7P	12.00	16.00
8P	14.00	18.00
9P	16.00	20.00
10P	18.00	22.00
11P	20.00	24.00
12P	22.00	26.00
13P	24.00	28.00
14P	26.00	30.00
15P	28.00	32.00
16P	30.00	34.00

Unit: mm



A2012 SERIES

2.00mm pitch wire to board connector

A2012WVA-F-XP

2.00mm pitch 180° Wafer

Reference Informations:

- *Material:Pin:Brass/Tin over Nickel
Insulator:Nylon 66,UL94V-0
- *Mates with CJT A2012H-XP series Housing
- *Color:White

Ordering Information:

A2012WVA-F-XP - *** - ** - **
1 2 3 4

- Part No.
- Material:
(Blank):Nylon 66,UL94V-0
GWT:Nylon 66,UL94V-0,GWT 750°C
- Color:
(Blank):White
BK:Black PK:Pink
RD:Red YL:Yellow
BL:Blue LY:Lemon yellow
GN:Green VY:Vivid yellow
OR:Orange LE:Light blue
BR:Brown GY:Gray
VI:Violet TR:Tomato red
- Finish:
(blank):Tin over Nickel
G:Gold over Nickel

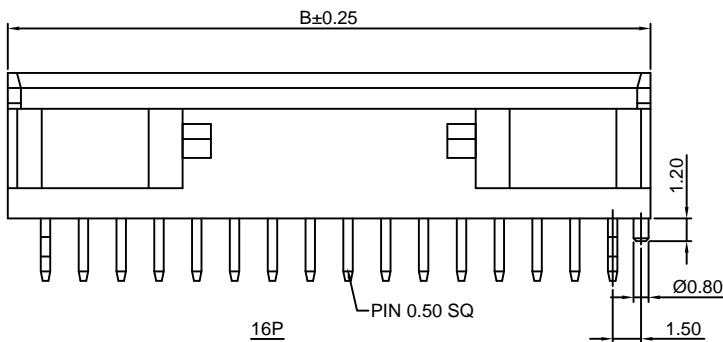
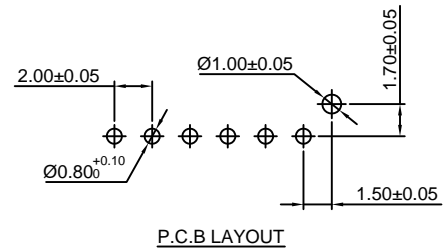
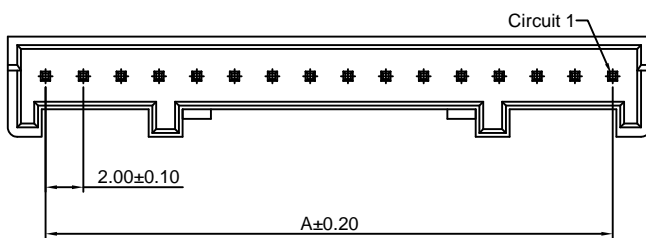
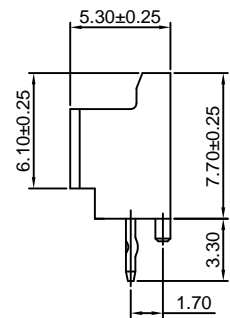
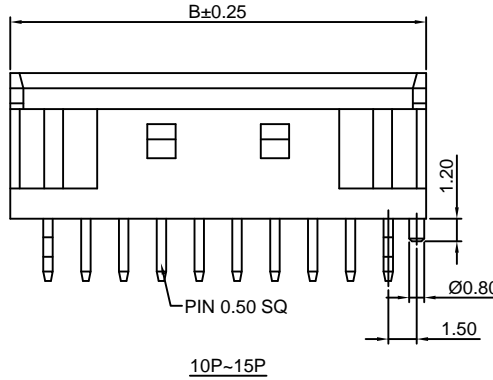
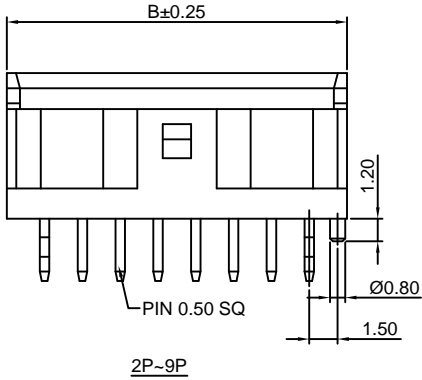
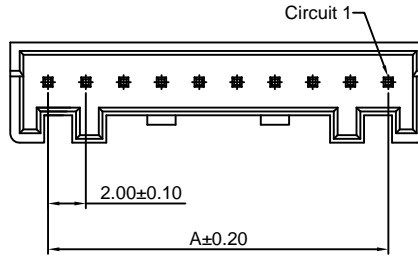
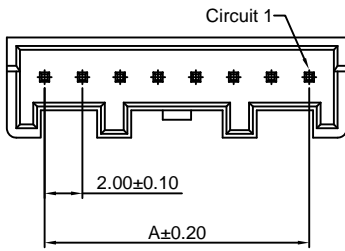

Ordering Information & Dimensions:

PART NO.	Dimensions	
	A	B
2P	2.00	6.00
3P	4.00	8.00
4P	6.00	10.00
5P	8.00	12.00
6P	10.00	14.00
7P	12.00	16.00
8P	14.00	18.00
9P	16.00	20.00
10P	18.00	22.00
11P	20.00	24.00
12P	22.00	26.00
13P	24.00	28.00
14P	26.00	30.00
15P	28.00	32.00
16P	30.00	34.00

Unit: mm

CJT_{CONN} A2012 SERIES

2.00mm pitch wire to board connector

A2012WRA-F-XP

2.00mm pitch 90° Wafer

Reference Informations:

- *Material:Pin:Brass/Tin over Nickel
Insulator:Nylon 66,UL94V-0
- *Mates with CJT A2012H-XP series Housing
- *Color:White

Ordering Information:

A2012WRA-F-XP - *** - ** - **
1 2 3 4

1.Part No.

2.Material:

(Blank):Nylon 66,UL94V-0

GWT:Nylon 66,UL94V-0,GWT 750 °C

3.Color:

(Blank):White

BK:Black

RD:Red

BL:Blue

GN:Green

OR:Orange

BR:Brown

VI:Violet

PK:Pink

YL:Yellow

LY:Lemon yellow

VY:Vivid yellow

LE:Light blue

GY:Gray

TR:Tomato red

4.Finish:

(blank):Tin over Nickel

G:Gold over Nickel

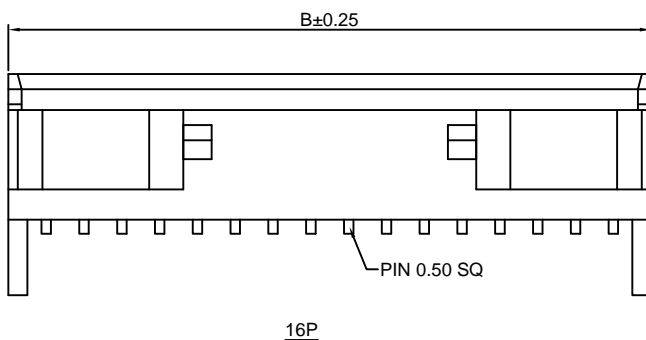
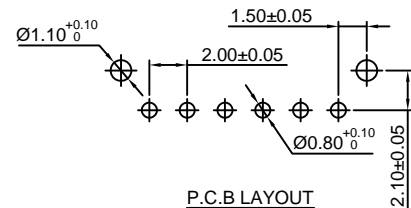
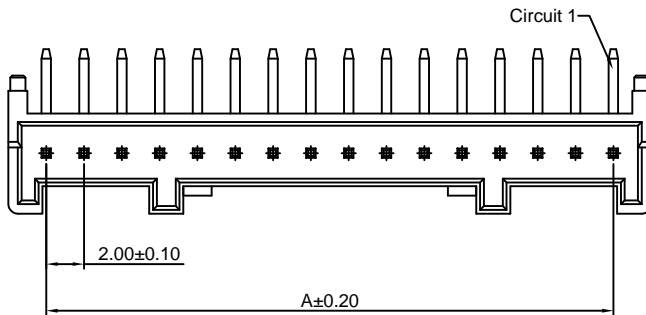
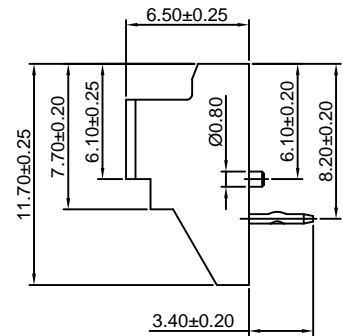
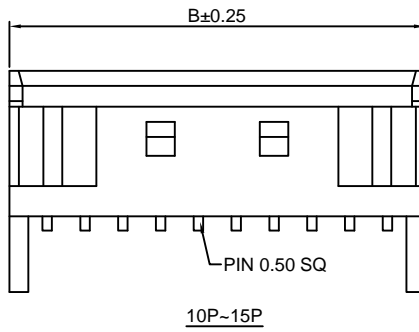
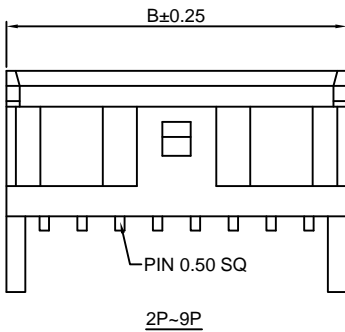
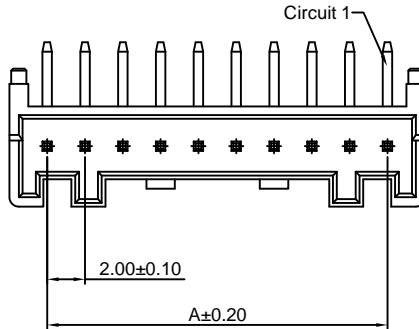
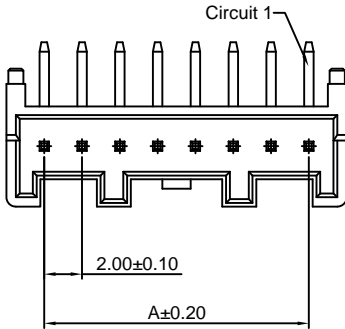

Ordering Information & Dimensions:

PART NO.	Dimensions	
	A	B
2P	2.00	6.00
3P	4.00	8.00
4P	6.00	10.00
5P	8.00	12.00
6P	10.00	14.00
7P	12.00	16.00
8P	14.00	18.00
9P	16.00	20.00
10P	18.00	22.00
11P	20.00	24.00
12P	22.00	26.00
13P	24.00	28.00
14P	26.00	30.00
15P	28.00	32.00
16P	30.00	34.00

Unit: mm



A2012 SERIES

2.00mm pitch wire to board connector

A2012WV-2xXP

2.00mm pitch 180° Dual Row Wafer

Reference Informations:

- *Material:Pin:Phosphor Bronze/Tin over Nickel
Insulator:Nylon 66,UL94V-0
- *Mates with CJT A2012HD-2xXP series Dual Row Housing
- *Color:Ivory

Ordering Information:

A2012WV-2xXP - *** - **
1 2 3

- Part No.
- Material:
(Blank):Nylon 66,UL94V-0
GWT:Nylon 66,UL94V-0,GWT 750 °C
- Finish:
(blank):Tin over Nickel
G:Gold over Nickel

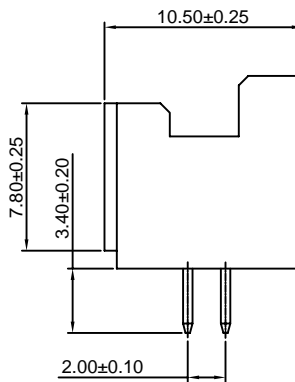
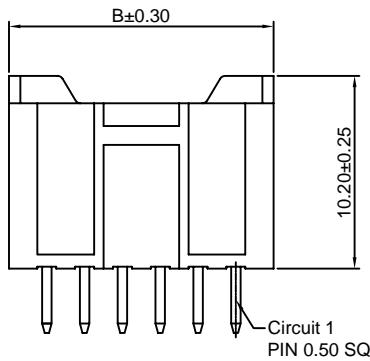
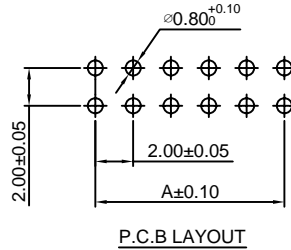
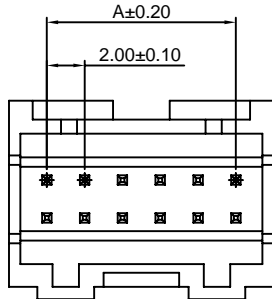

Ordering Information & Dimensions:

PART NO.	Dimensions	
	A	B
2x5P	8.00	12.00
2x6P	10.00	14.00
2x7P	12.00	16.00
2x8P	14.00	18.00
2x9P	16.00	20.00
2x10P	18.00	22.00
2x11P	20.00	24.00
2x12P	22.00	26.00
2x20P	38.00	42.00

Unit: mm

A2012WV-F-2xXP

2.00mm pitch 180° Dual Row Wafer

Reference Informations:

- *Material:Pin:Phosphor Bronze/Tin over Nickel
Insulator:Nylon 66,UL94V-0
- *Mates with CJT A2012HD-2xXP series Dual Row Housing
- *Color:Ivory

Ordering Information:

A2012WV-F-2xXP - *** - **
1 2 3

- Part No.
- Material:
(Blank):Nylon 66,UL94V-0
GWT:Nylon 66,UL94V-0,GWT 750 °C
- Finish:
(blank):Tin over Nickel
G:Gold over Nickel

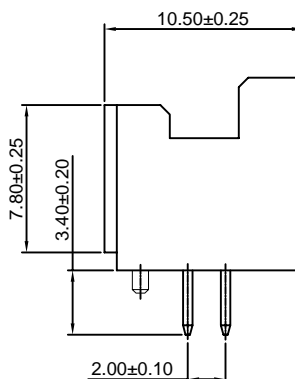
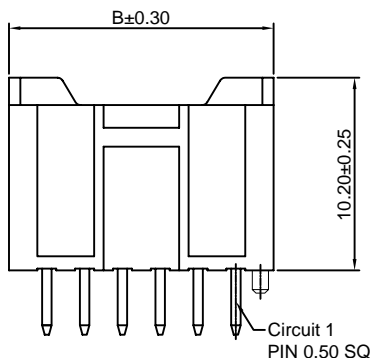
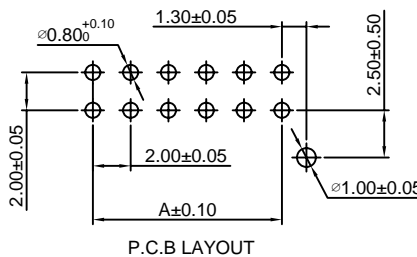
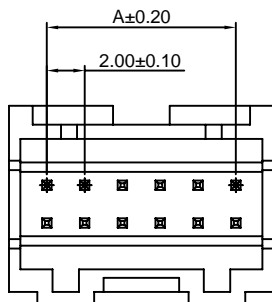

Ordering Information & Dimensions:

PART NO.	Dimensions	
	A	B
2x5P	8.00	12.00
2x6P	10.00	14.00
2x7P	12.00	16.00
2x8P	14.00	18.00
2x9P	16.00	20.00
2x10P	18.00	22.00
2x11P	20.00	24.00
2x12P	22.00	26.00
2x20P	38.00	42.00

Unit: mm

CJT_{CONN} A2012 SERIES

2.00mm pitch wire to board connector

A2012WR-F-2xXP

2.00mm pitch 90° Dual Row Wafer

Reference Informations:

- *Material:Pin:Phosphor Bronze/Tin over Nickel
Insulator:Nylon 66,UL94V-0
- *Mates with CJT A2012HD-2xXP series Dual Row Housing
- *Color:White

Ordering Information:

A2012WR-F-2xXP - *** - **
1 2 3

- 1.Part No.
- 2.Material:
(Blank):Nylon 66,UL94V-0
GWT:Nylon 66,UL94V-0,GWT 750°C
- 3.Finish:
(blank):Tin over Nickel
G:Gold over Nickel

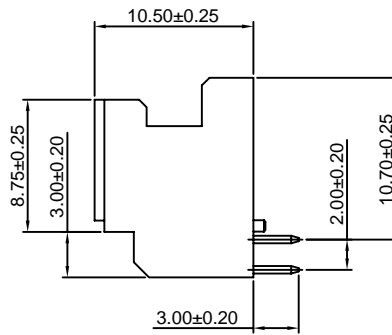
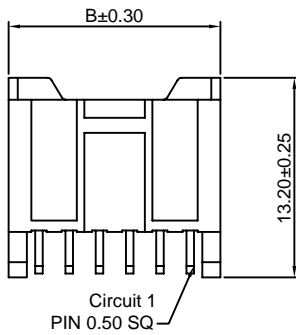
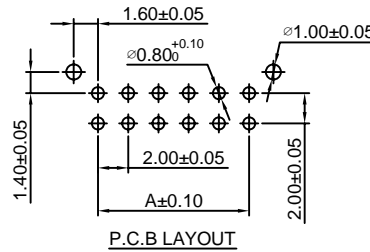
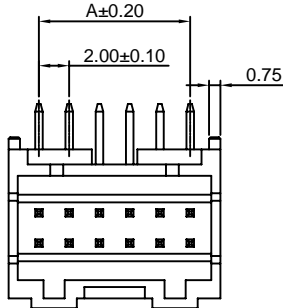

Ordering Information & Dimensions:

PART NO.	Dimensions	
	A	B
2x5P	8.00	12.00
2x6P	10.00	14.00
2x7P	12.00	16.00
2x8P	14.00	18.00
2x9P	16.00	20.00
2x10P	18.00	22.00
2x11P	20.00	24.00
2x12P	22.00	26.00
2x20P	38.00	42.00

Unit: mm