

REV.	ECR/N NO./DESCRIPTION	DATE	DRAWN	CHECKED	APPROVE
1	SN15028	04/09'15	Jinjin.Tu	Vito	Barney

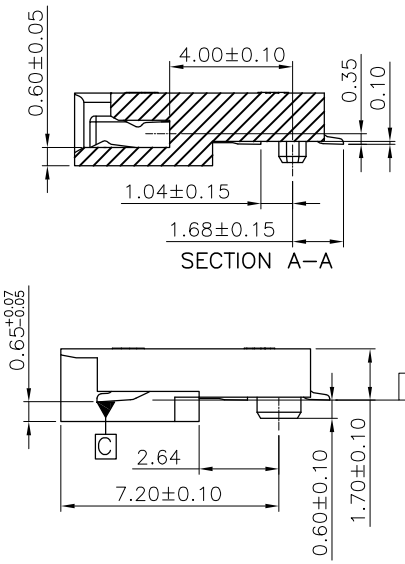

- NOTES:
- MATERIAL SPECIFICATION:
 - 1-1. HOUSING: LCP+40%GF, UL94V-0, COLOR: BLACK.
 - 1-2. CONTACT: COPPER ALLOY C1065.
 - 1-3. SMT TAB: S50C.
 - PLATING SPECIFICATION:
 - 2-1. CONTACT: 50u" MIN. NICKEL UNDER PLATING OVER ALL. G/F PLATING ON SOLDER AREA. GOLD PLATING ON CONTACT AREA: SEE TABLE
 - 2-2. SMT TAB: 50u" MIN. NICKEL UNDER PLATING OVER ALL. 80u" MIN. MATTE TIN PLATING ON SOLDER AREA.
 - HF COMPLIANT.
 - DATE CODE: XXXXXX
 - DAY
 - WEEK
 - YEAR
 - MECHANICAL PERFORMANCE:
 - 5-1. DURABILITY: 25 CYCLES.
 - ELECTRICAL PERFORMANCE:
 - 6-1. CURRENT: 0.5A PER PIN.
 - 6-2. LLCR: INITIAL 55mΩ MAX.; FINAL ΔLLCR=20mΩ MAX..
 - RESISTANCE TO HEAT: THE TEMPERATURE SHALL BE 260±5°C MAINTAINING 10±1 SECONDS.
 - PRODUCT NUMBER NOTE

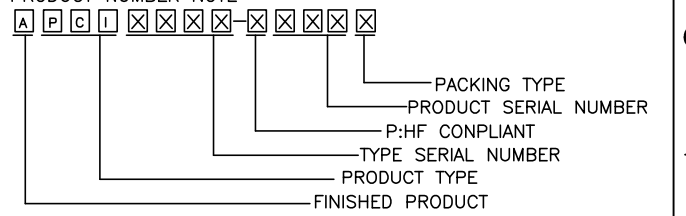

PART NO.	CONTACT PLATING	DURABILITY
APCI0157-P002A	10u" MIN. GOLD	25 CYCLES.
APCI0157-P001A	1-3u" MIN. GOLD	25 CYCLES.

GENERAL TOLERANCES UNLESS SPECIFIED		PART NO.	TITLE
.X ± 0.35	X.° ± 3°	SEE TABLE	
.XX ± 0.25	X.° ± 2°	APPROVED BY	
.XXX ± 0.15	.XX° ± 1°	Barney	0.5 PITCH 67PINS M.2 M1.8(KEY-B)
CUSTOMER DRAWING		CHECKED BY	DWG NO.
		Vito	AP-APCI0157-P
SIZE	UNITS	DRAWN BY	SHEET SCALE REV
A4	MM [INCH]	Jinjin.Tu	

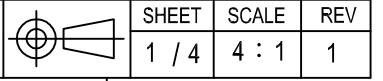

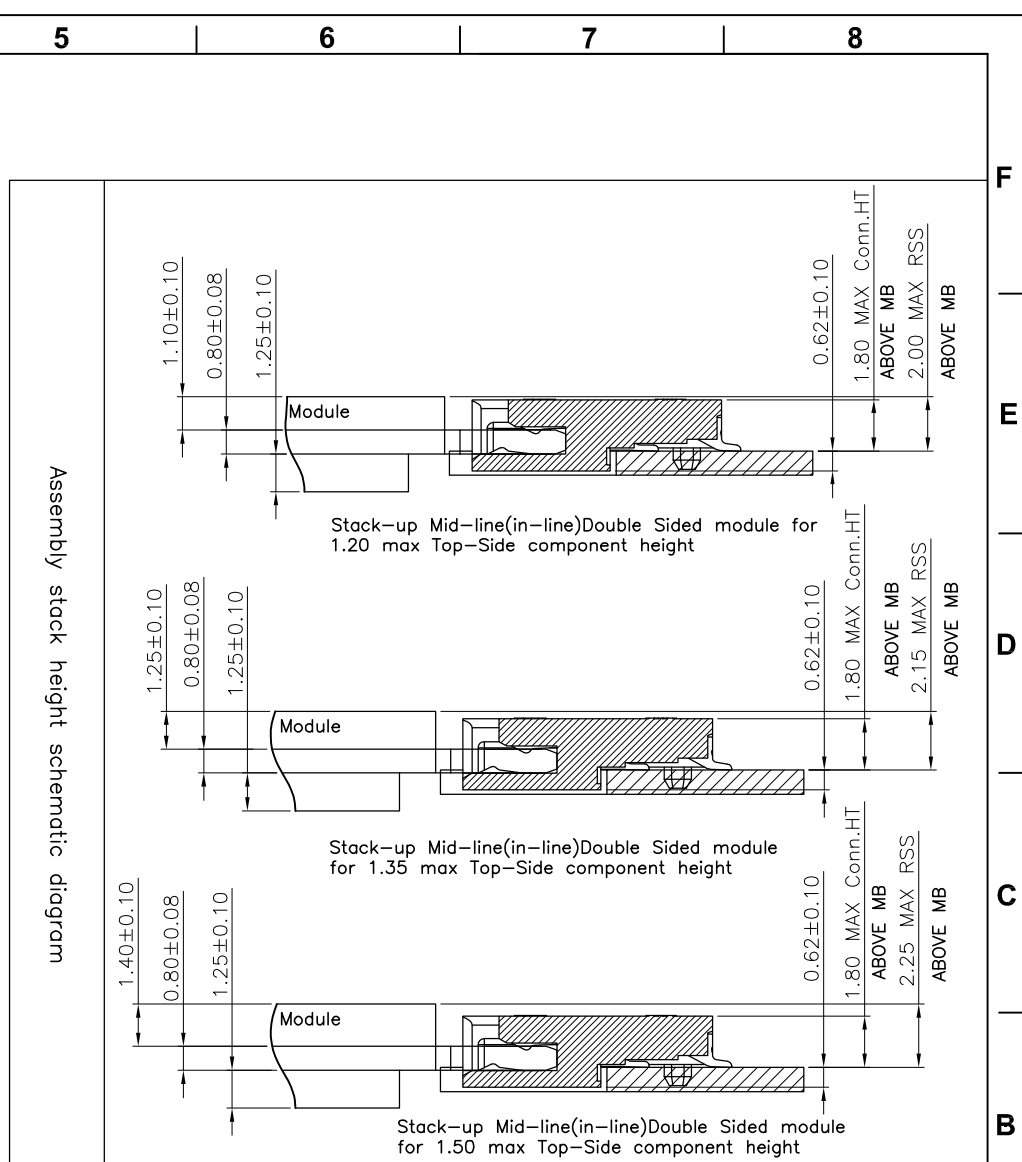
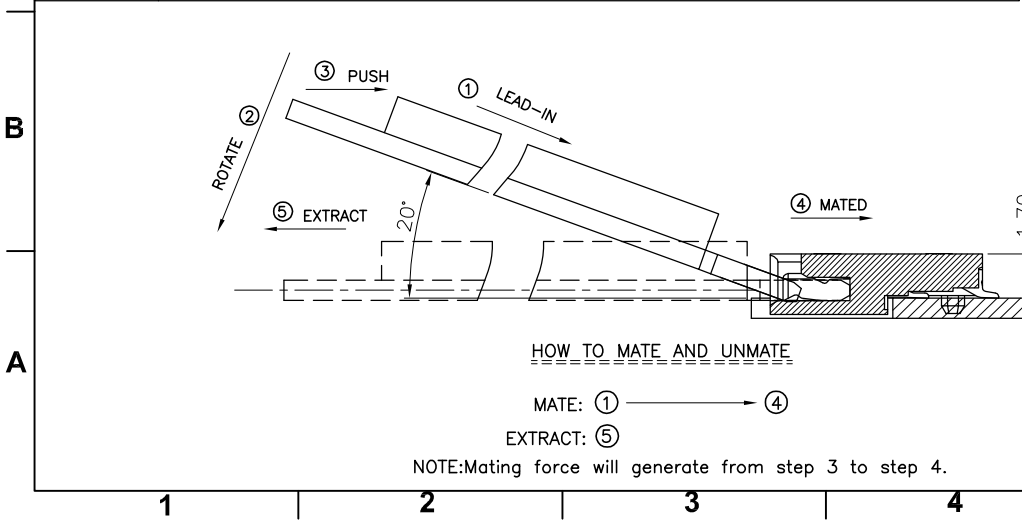
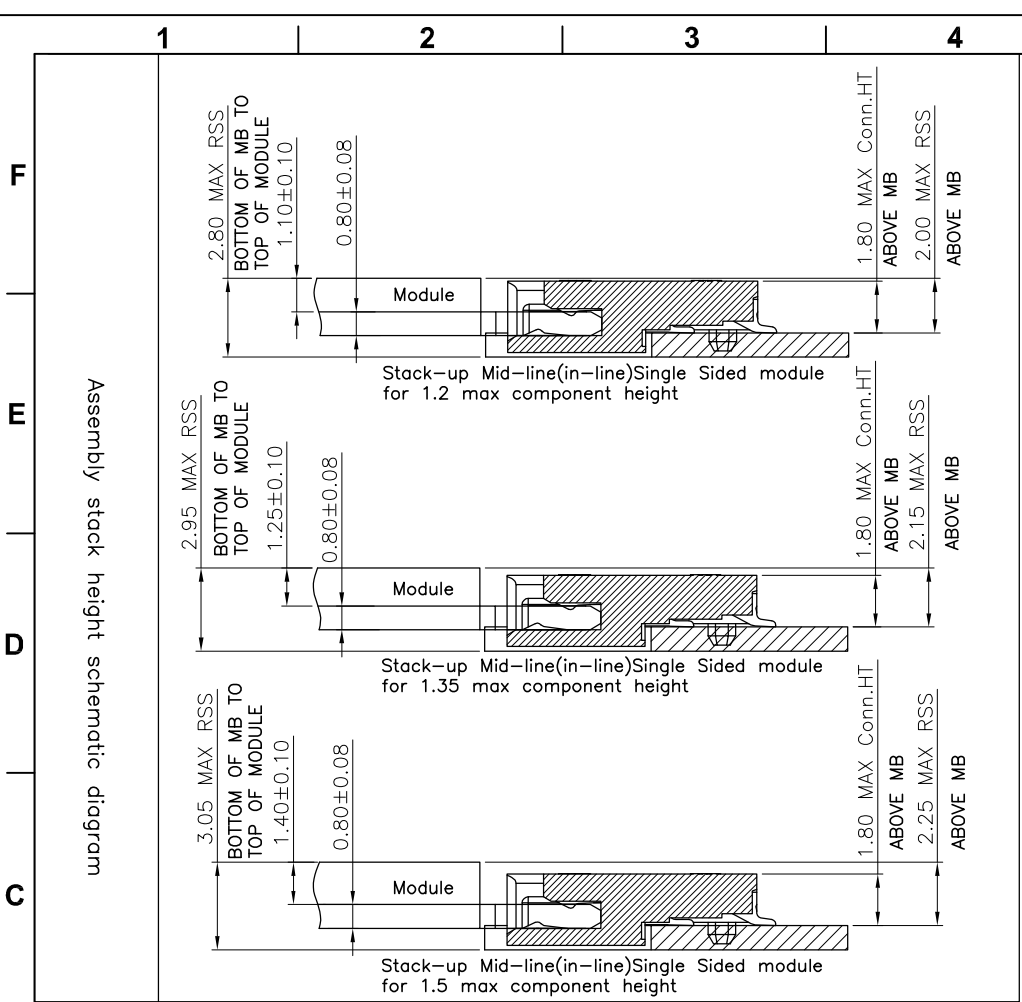

GENERAL TOLERANCES UNLESS SPECIFIED		PART NO. SEE TABLE		LOTES		
$X \pm 0.35$	$X^\circ \pm 3^\circ$	APPROVED BY Barney				
$.XX \pm 0.25$	$.X^\circ \pm 2^\circ$	CHECKED BY Vito		DWG NO. AP-APCI0157-P		
$.XXX \pm 0.15$	$.XX^\circ \pm 1^\circ$	CUSTOMER DRAWING		DRAWN BY Jinjin.Tu		
SIZE A4	UNITS MM[INCH]	DRAWN BY Jinjin.Tu		SHEET 2 / 4	SCALE 4 : 1	REV 1

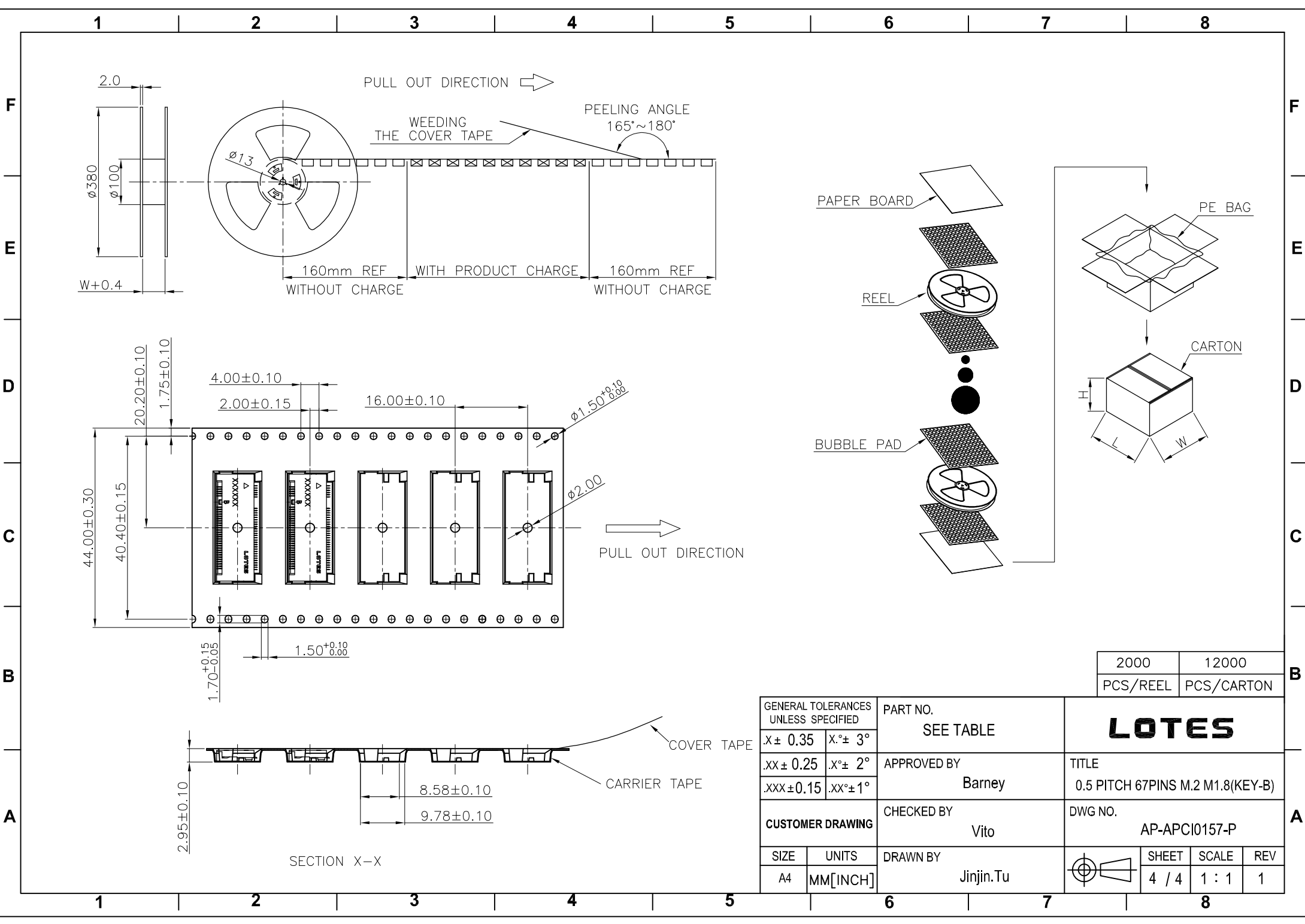

2000	12000
PCS/REEL	PCS/CARTON

GENERAL TOLERANCES UNLESS SPECIFIED		PART NO.		LOTES			
SEE TABLE		SEE TABLE					
$.X \pm 0.35$	$X^\circ \pm 3^\circ$	APPROVED BY		TITLE			
$.XX \pm 0.25$	$.X^\circ \pm 2^\circ$	Barney		0.5 PITCH 67PINS M.2 M1.8(KEY-B)			
$.XXX \pm 0.15$	$.XX^\circ \pm 1^\circ$	CHECKED BY		DWG NO.			
CUSTOMER DRAWING		Vito		AP-APCI0157-P			
SIZE	UNITS	DRAWN BY			SHEET	SCALE	REV
A4	MM [INCH]	Jinjin.Tu			4 / 4	1 : 1	1