



RS221S, RS222S RS221, RS222, RS224

500kHz, Rail-to-Rail I/O CMOS Operational Amplifier

FEATURES

- **GAIN BANDWIDTH:500kHz**
- **RAIL-TO-RAIL INPUT AND OUTPUT**
0.8mV Typical Vos
- **INPUT VOLTAGE RANGE: -0.1V to +5.6V**
with $V_s = 5.5V$
- **SUPPLY RANGE: +2.5V to +5.5V**
- **SHUTDOWN: RS221S/RS222S**
- **SPECIFIED UP TO +125°C**
- **MicroSIZE PACKAGES: SOT23-5, SOT23-6**

APPLICATIONS

- **SENSORS**
- **PHOTODIODE AMPLIFICATION**
- **ACTIVE FILTERS**
- **TEST EQUIPMENT**
- **DRIVING A/D CONVERTERS**

DESCRIPTION

The RS221, RS222, RS224, RS221S, RS222S families of products offer low voltage operation and rail-to-rail input and output, as well as excellent speed/power consumption ratio, providing an excellent bandwidth (500kHz) and slew rate of 0.18V/us. The op-amps are unity gain stable and feature an ultra-low input bias current.

The devices are ideal for sensor interfaces, active filters and portable applications. The RS221S, RS222S include a shutdown mode. Under logic control, the amplifiers can be switched from normal operation to a standby current that is less than 1uA. The RS221, RS222, RS224, RS221S, RS222S families of operational amplifiers are specified at the full temperature range of $-40^{\circ}C$ to $+125^{\circ}C$ under single or dual power supplies of 2.5V to 5.5V.

PIN CONFIGURATIONS

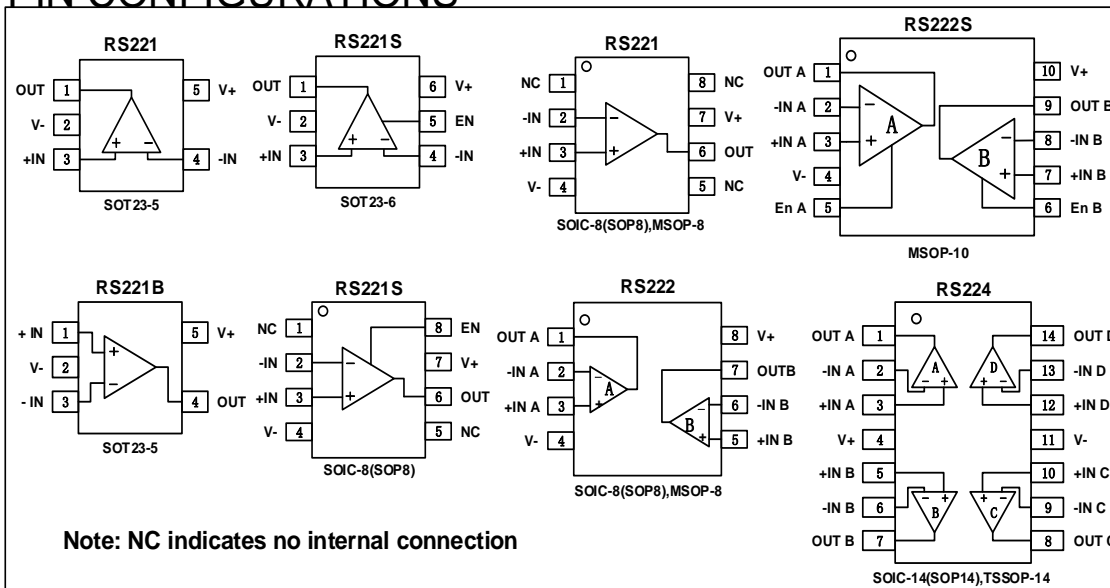

ABSOLUTE MAXIMUM RATINGS ⁽¹⁾

Supply Voltage, V+ to V-	7.0V
Input Terminals, Voltage ⁽²⁾	- 0.5 to (V+) + 0.5V
Current ⁽²⁾	±10mA
Storage Temperature	-65°C to +150°C
Operating Temperature	-40°C to +125°C
Junction Temperature	150°C
Package Thermal Resistance @ T _A = +25°C	
SOT23-5, SOT23-6	200°C/W
MSOP-10, SOIC-8	150°C/W
SOIC-14, TSSOP-14	100°C/W
Lead Temperature (Soldering, 10s)	260°C
ESD Susceptibility	
HBM	5000V
MM	400V



ESD SENSITIVITY CAUTION

ESD damage can range from subtle performance degradation to complete device failure. Precision integrated circuits may be more susceptible to damage because very small parametric changes could cause the device not to meet its published specifications.

- (1) Stresses above these ratings may cause permanent damage. Exposure to absolute maximum conditions for extended periods may degrade device reliability. These are stress ratings only, and functional operation of the device at these or any other conditions beyond those specified is not implied.
- (2) Input terminals are diode-clamped to the power-supply rails. Input signals that can swing more than 0.5V beyond the supply rails should be current-limited to 10mA or less.

PACKAGE/ORDERING INFORMATION

PRODUCT	ORDERING NUMBER	TEMPERATURE RANGE	PACKAGE LEAD	PACKAGE MARKING	PACKAGE OPTION
RS221	RS221XK	-40°C~125°C	SOIC-8(SOP8)	RS221	Tape and Reel,2500
	RS221XF	-40°C~125°C	SOT23-5	221	Tape and Reel,3000
	RS221BXF	-40°C~125°C	SOT23-5	221B	Tape and Reel,3000
	RS221XM	-40°C~125°C	MSOP-8	RS221	Tape and Reel,3000
RS221S	RS221SXK	-40°C~125°C	SOIC-8(SOP8)	RS221S	Tape and Reel,2500
	RS221SXH	-40°C~125°C	SOT23-6	221S	Tape and Reel,3000
RS222	RS222XK	-40°C~125°C	SOIC-8(SOP8)	RS222	Tape and Reel,2500
	RS222XM	-40°C~125°C	MSOP-8	RS222	Tape and Reel,3000
RS222S	RS222SXN	-40°C~125°C	MSOP-10	RS222S	Tape and Reel,3000
RS224	RS224XP	-40°C~125°C	SOIC-14(SOP14)	RS224	Tape and Reel,2500
	RS224XQ	-40°C~125°C	TSSOP-14	RS224	Tape and Reel,3000



ELECTRICAL CHARACTERISTICS

(At $T_A = +25^\circ\text{C}$, $V_S=5\text{V}$, $R_L = 200\text{k}\Omega$ connected to $V_S/2$, and $V_{OUT} = V_S/2$, unless otherwise noted.)

PARAMETER		CONDITIONS	T_J	RS221S, RS222S, RS221, RS222, RS224			UNIT	
				MIN	TYP	MAX		
POWER SUPPLY								
V_S	Operating Voltage Range		25°C	2.5		5.5	V	
I_Q	Quiescent Current/Amplifier		25°C		18	32	uA	
PSRR	Power-Supply Rejection Ratio	$V_S=2.5\text{V to }5.5\text{V},$ $V_{cm}=(V_-)+0.5\text{V}$	25°C	73	90		dB	
			-40°C to 125°C	67				
INPUT								
V_{os}	Input Offset Voltage		25°C		0.8	3.5	mV	
$V_{os\ TC}$	Input Offset Voltage Average Drift	-40°C to 125°C			2.9		uV/°C	
I_B	Input Bias Current		25°C		1	10	pA	
I_{os}	Input Offset Current		25°C		1	10	pA	
V_{cm}	Common-Mode Voltage Range	$V_S= 5.5\text{V}$	25°C	-0.1		5.6	V	
CMRR	Common-Mode Rejection Ratio	$V_S= 5.5\text{V}, V_{cm}$ $=-0.1\text{V to }4\text{V}$	25°C	74	90		dB	
			-40°C to 125°C	70				
			25°C	62	75			
			-40°C to 125°C	60				
OUTPUT								
AOL	Open-Loop Voltage Gain	$R_L=2\text{K}\Omega, V_o=$ $0.15\text{V to }4.85\text{V}$	25°C	88	98		dB	
			-40°C to 125°C	82				
			$R_L=10\text{K}\Omega, V_o=$ $0.05\text{V to }4.95\text{V}$	25°C	92	110		
			-40°C to 125°C	88				
	Output Swing From Rail	$R_L=2\text{K}\Omega$ $R_L=10\text{K}\Omega$	25°C		26		mV	
					6			
I_{out}	Output Current Source		25°C		27		mA	
FREQUENCY RESPONSE								
SR	Slew Rate		25°C		0.18		V/us	
GBP	Gain-Bandwidth Product		25°C		500		kHz	
PM	Phase Margin		25°C		64		°	
t_s	Setting Time,0.1%				14		us	
	Overload Recovery Time	$V_{IN}\cdot\text{Gain} \geq V_S$			5		us	
NOISE								
e_n	Input Voltage Noise Density	$f = 1\text{KHz}$	25°C		77		nV/√Hz	
		$f = 10\text{KHz}$	25°C		39		nV/√Hz	
ENABLE/SHUTDOWN(RS221S,RS222S)								
$I_{Q(OFF)}$	Supply Current in Shutdown		25°C		<1		uA	
t_{OFF}			25°C		3		us	
t_{ON}			25°C		20		us	
V_L	Shut Down		25°C	V_-		$(V_-) +0.8$	V	
V_H	Amplifier Is Active		25°C	$(V_-) +2$		V_+	V	

TYPICAL CHARACTERISTICS

At $T_A = +25^\circ\text{C}$, $V_S = 5\text{V}$, $R_L = 200\text{k}\Omega$ connected to $V_S/2$, $V_{OUT} = V_S/2$, unless otherwise noted.

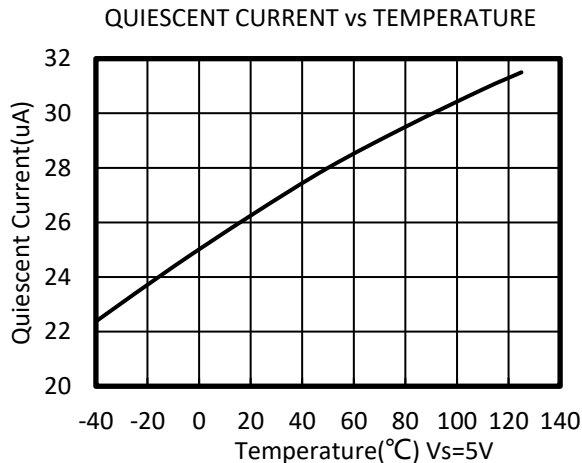
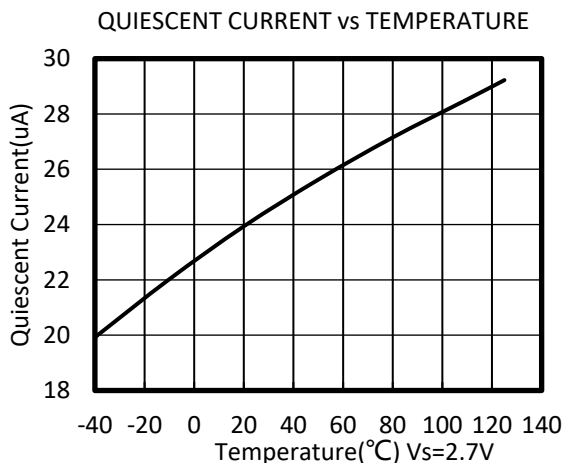
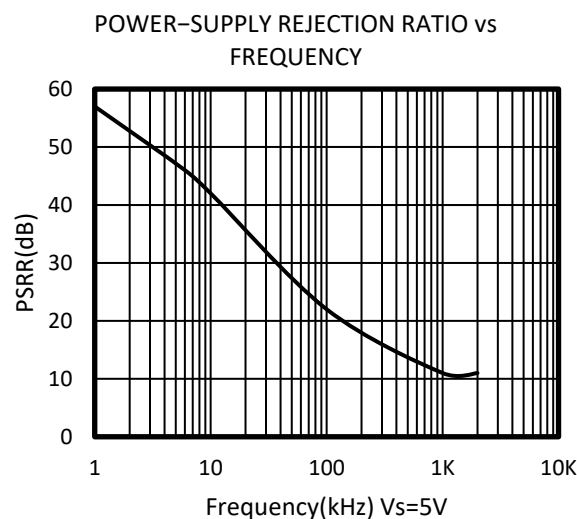
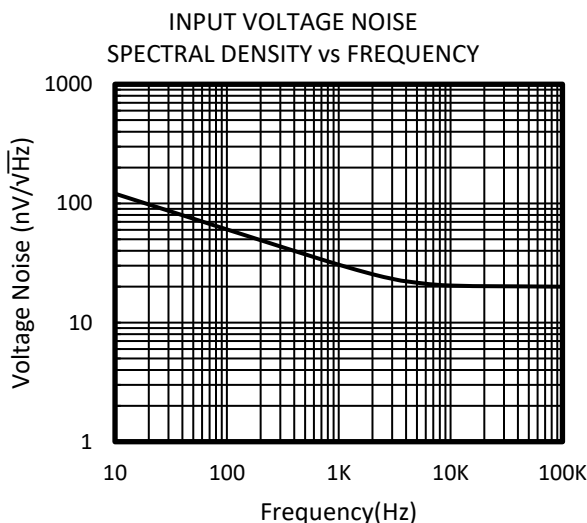
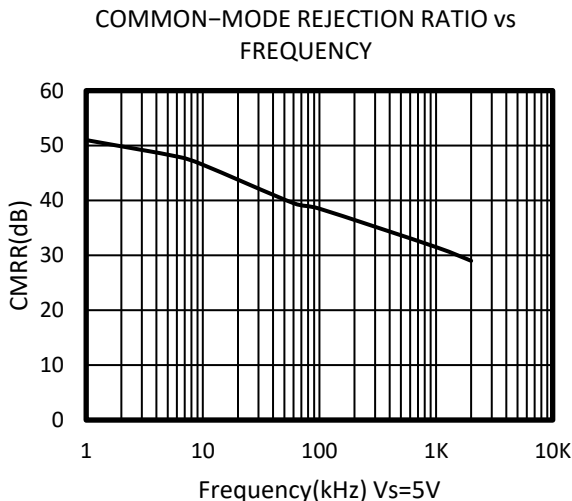
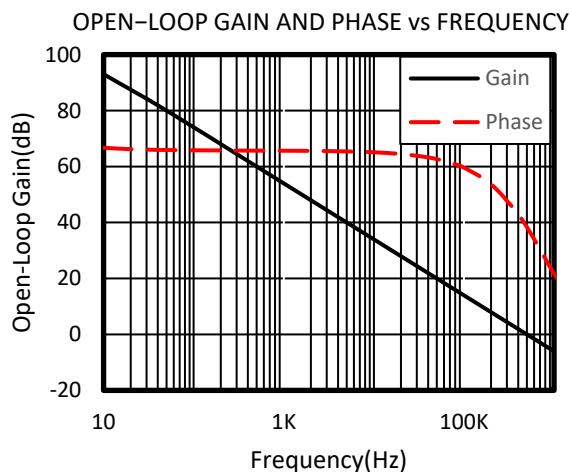

TYPICAL CHARACTERISTICS

At $T_A = +25^\circ\text{C}$, $V_S = 5\text{V}$, $R_L = 200\text{k}\Omega$ connected to $V_S/2$, $V_{OUT} = V_S/2$, unless otherwise noted.

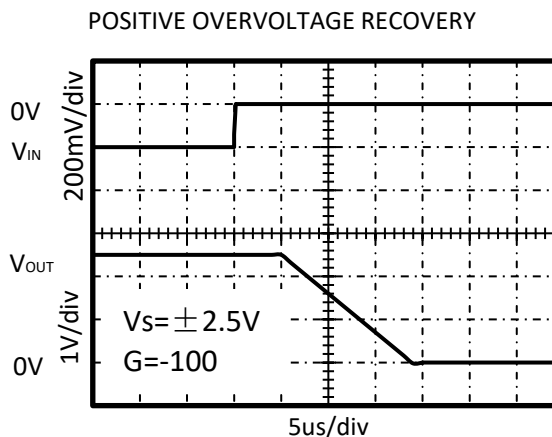
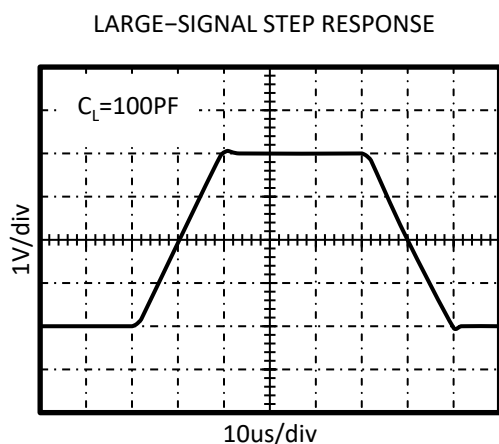
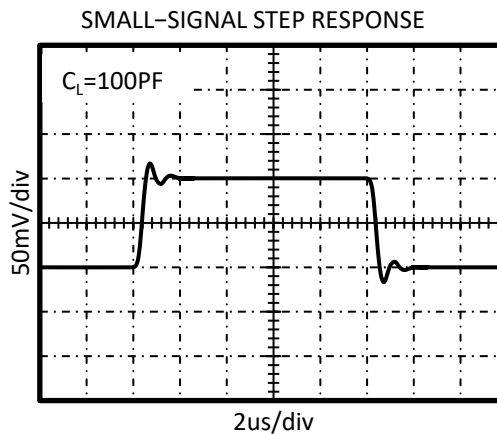
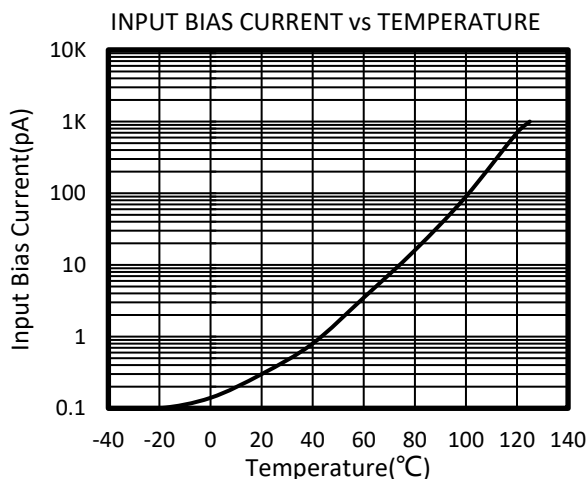
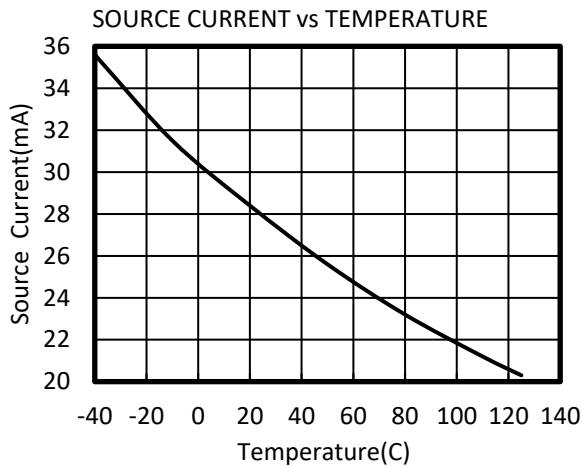
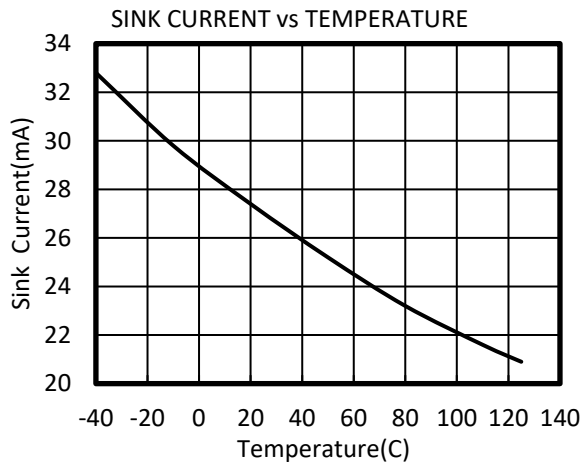

TYPICAL CHARACTERISTICS

At $T_A = +25^\circ\text{C}$, $V_S = 5\text{V}$, $R_L = 200\text{k}\Omega$ connected to $V_S/2$, $V_{OUT} = V_S/2$, unless otherwise noted.

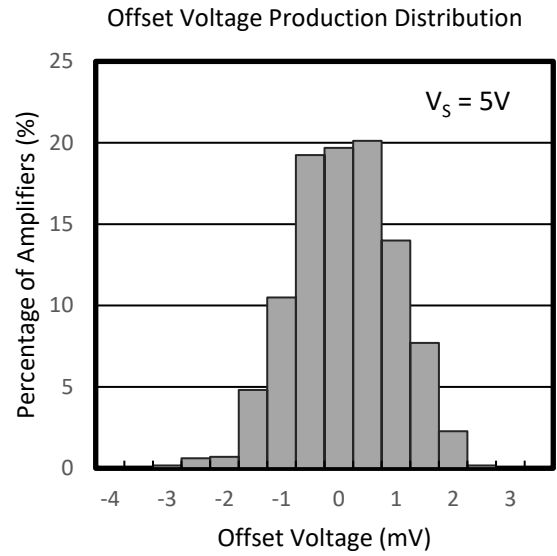
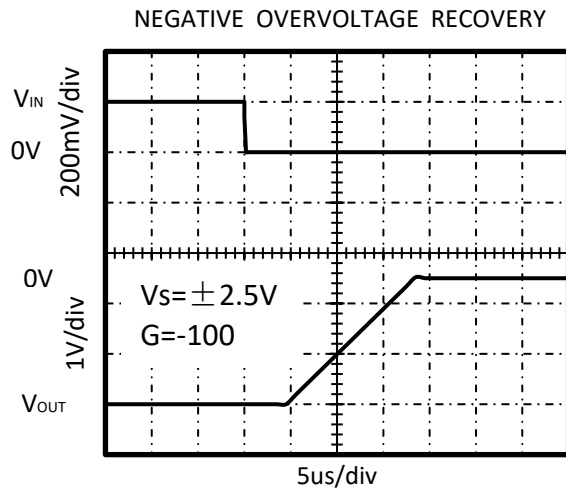

APPLICATION NOTES

The RS221, RS222, RS224, RS221S, RS222S are high precision, rail-to-rail operational amplifiers that can be run from a single-supply voltage 2.5V to 5.5V ($\pm 1.25V$ to $\pm 2.75V$). Supply voltages higher than 7V (absolute maximum) can permanently damage the amplifier.

Rail-to-rail input and output swing significantly increases dynamic range, especially in low-supply applications.

Good layout practice mandates use of a 0.1uF capacitor place closely across the supply pins.

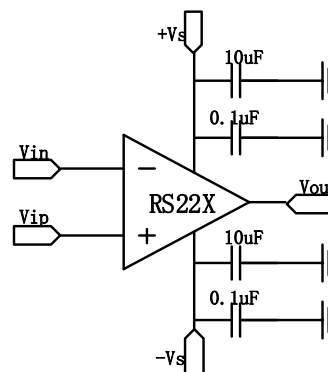

Figure1. Amplifier with Bypass Capacitors

RS221S/RS222S ENABLE FUNCTION

The RS221S/RS222S includes a shutdown mode. Under logic control, the amplifiers can be switched from normal mode to a standby current of 1uA. When the Enable pin is connected to high, the amplifier is active. Connecting Enable low disables the amplifier, and places the amplifier, and place the output in a high-impedance state.

LAYOUT GUIDELINS

Attention to good layout practices is always recommended. Keep traces short. When possible, use a PCB ground plane with surface-mount components placed as close to the device pins as possible. Place a 0.1uF capacitor closely across the supply pins.

These guidelines should be applied throughout the analog circuit to improve performance and provide benefits such as reducing the EMI susceptibility.

INSTRUMENTATION AMPLIFIER

In the three-op amp, instrumentation amplifier configuration shown in Figure2,

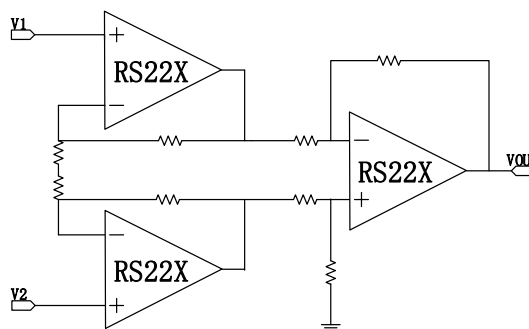
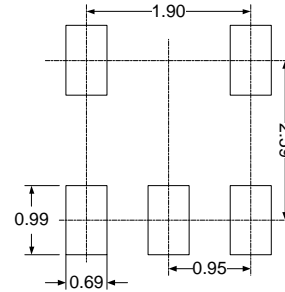
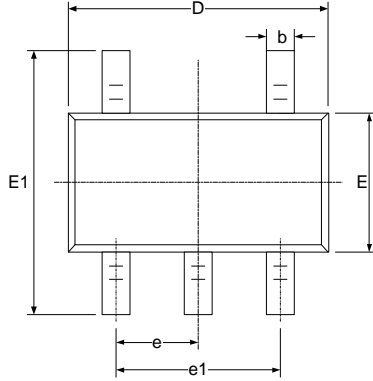

Figure2. Amplifier instrumentation amplifier

PACKAGE OUTLINE DIMENSIONS

SOT23-5



RECOMMENDED LAND PATTERN (Unit: mm)

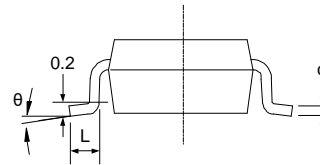
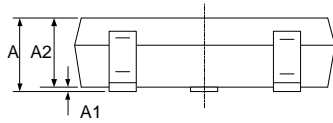

Symbol	Dimensions In Millimeters		Dimensions In Inches	
	Min	Max	Min	Max
A	1.050	1.250	0.041	0.049
A1	0.000	0.100	0.000	0.004
A2	1.050	1.150	0.041	0.045
b	0.300	0.500	0.012	0.020
c	0.100	0.200	0.004	0.008
D	2.820	3.020	0.111	0.119
E	1.500	1.700	0.059	0.067
E1	2.650	2.950	0.104	0.116
e	0.950(BSC)		0.037(BSC)	
e1	1.800	2.000	0.071	0.079
L	0.300	0.600	0.012	0.024
θ	0°	8°	0°	8°

SOT23-6

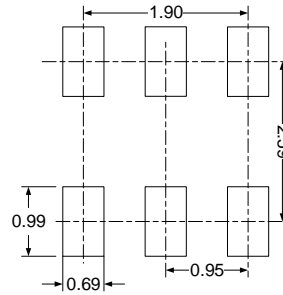
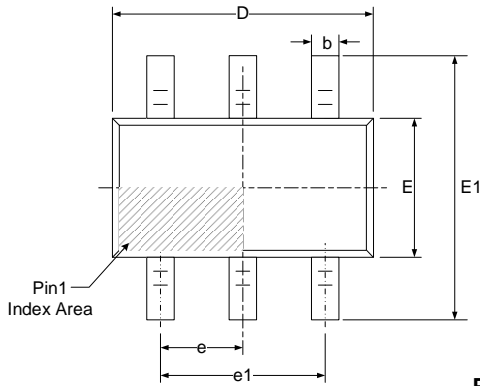

RECOMMENDED LAND PATTERN (Unit: mm)

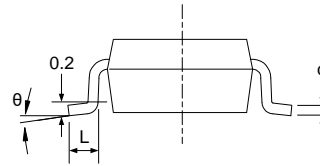
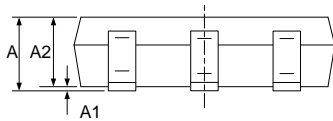

Symbol	Dimensions In Millimeters		Dimensions In Inches	
	Min	Max	Min	Max
A	1.050	1.250	0.041	0.049
A1	0.000	0.100	0.000	0.004
A2	1.050	1.150	0.041	0.045
b	0.300	0.500	0.012	0.020
c	0.100	0.200	0.004	0.008
D	2.820	3.020	0.111	0.119
E	1.500	1.700	0.059	0.067
E1	2.650	2.950	0.104	0.116
e	0.950(BSC)		0.037(BSC)	
e1	1.800	2.000	0.071	0.079
L	0.300	0.600	0.012	0.024
θ	0°	8°	0°	8°

MSOP-8

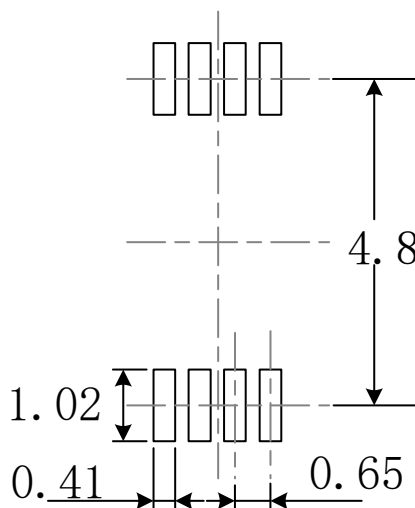
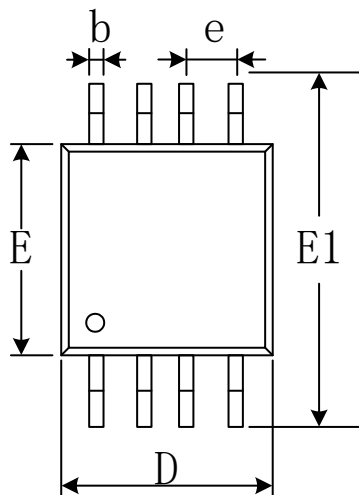

RECOMMENDED LAND PATTERN (Unit: mm)

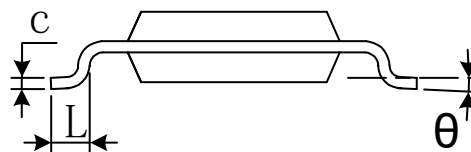
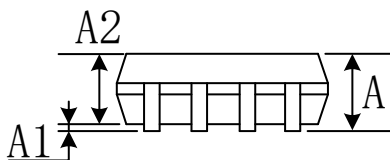

Symbol	Dimensions In Millimeters		Dimensions In Inches	
	Min	Max	Min	Max
A	0.820	1.100	0.032	0.043
A1	0.020	0.150	0.001	0.006
A2	0.750	0.950	0.030	0.037
b	0.250	0.380	0.010	0.015
c	0.090	0.230	0.004	0.009
D	2.900	3.100	0.114	0.122
e	0.650(BSC)		0.026(BSC)	
E	2.900	3.100	0.114	0.122
E1	4.750	5.050	0.187	0.199
L	0.400	0.800	0.016	0.031
θ	0°	6°	0°	6°

MSOP-10

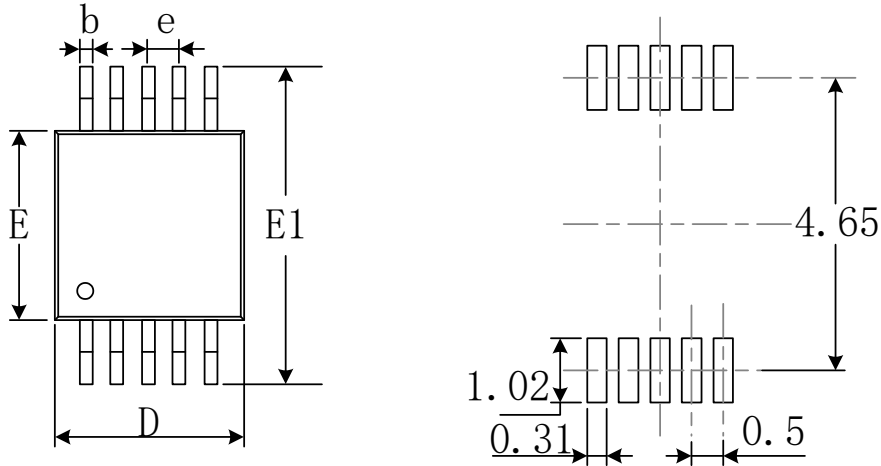

RECOMMENDED LAND PATTERN (Unit: mm)

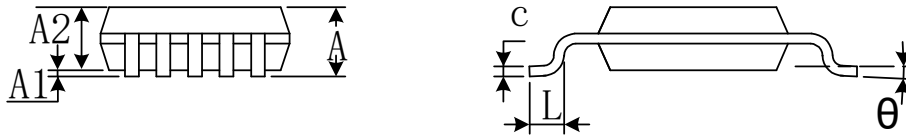

Symbol	Dimensions In Millimeters		Dimensions In Inches	
	Min	Max	Min	Max
A	0.820	1.100	0.032	0.043
A1	0.020	0.150	0.001	0.006
A2	0.750	0.950	0.030	0.037
b	0.180	0.280	0.007	0.011
c	0.090	0.230	0.004	0.009
D	2.900	3.100	0.114	0.122
e	0.50(BSC)		0.020(BSC)	
E	2.900	3.100	0.114	0.122
E1	4.750	5.050	0.187	0.199
L	0.400	0.800	0.016	0.031
θ	0°	6°	0°	6°

TSSOP-14

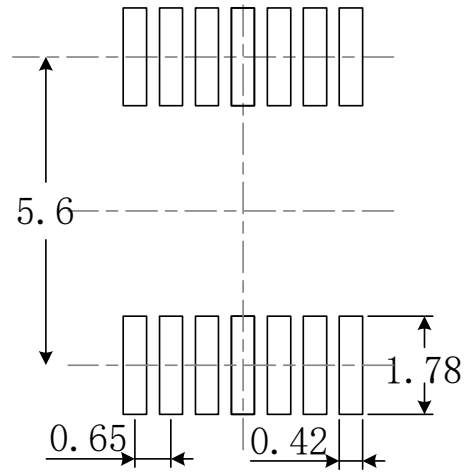
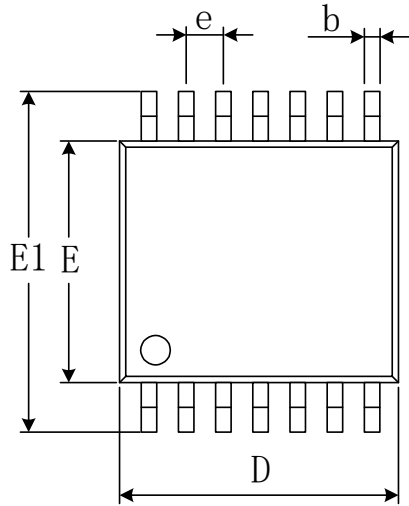

RECOMMENDED LAND PATTERN (Unit: mm)

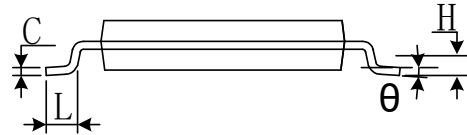
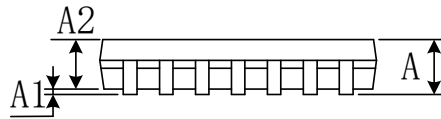

Symbol	Dimensions In Millimeters		Dimensions In Inches	
	Min	Max	Min	Max
A		1.200		0.047
A1	0.050	0.150	0.002	0.006
A2	0.800	1.050	0.031	0.041
b	0.190	0.300	0.007	0.012
c	0.090	0.200	0.004	0.008
D	4.860	5.100	0.191	0.201
E	4.300	4.500	0.169	0.177
E1	6.250	6.550	0.246	0.258
e	0.650(BSC)		0.026(BSC)	
L	0.500	0.700	0.020	0.028
H	0.25(TYP)		0.01(TYP)	
θ	1°	7°	1°	7°

SOIC-8(SOP8)

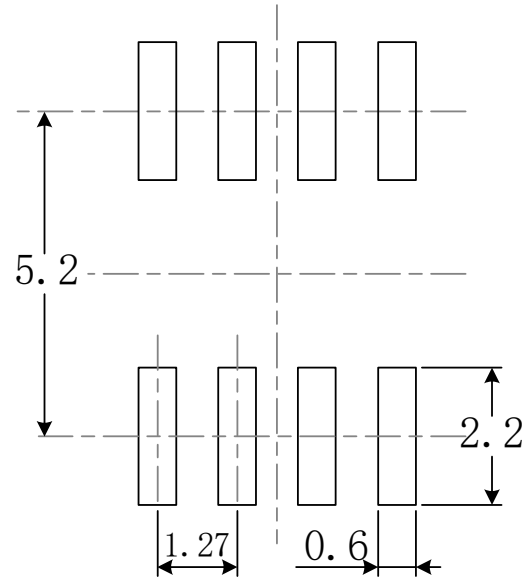
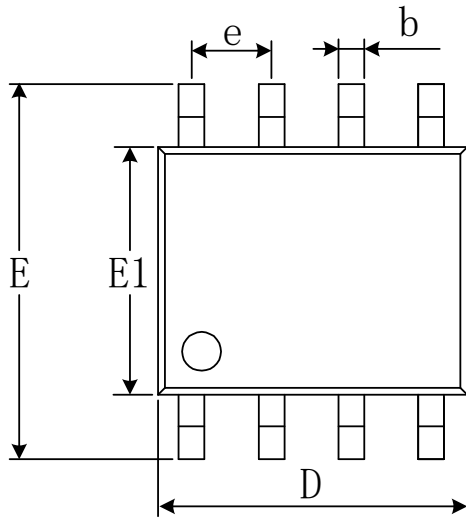

RECOMMENDED LAND PATTERN (Unit: mm)

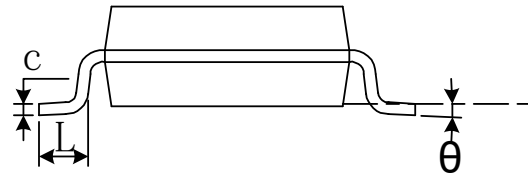
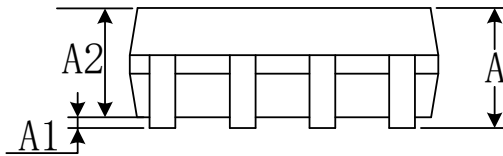

Symbol	Dimensions In Millimeters		Dimensions In Inches	
	Min	Max	Min	Max
A	1.350	1.750	0.053	0.069
A1	0.100	0.250	0.004	0.010
A2	1.350	1.550	0.053	0.061
b	0.330	0.510	0.013	0.020
c	0.170	0.250	0.007	0.010
D	4.800	5.000	0.189	0.197
e	1.270(BSC)		0.050(BSC)	
E	5.800	6.200	0.228	0.244
E1	3.800	4.000	0.150	0.157
L	0.400	1.270	0.016	0.050
θ	0°	8°	0°	8°

SOIC-14(SOP14)

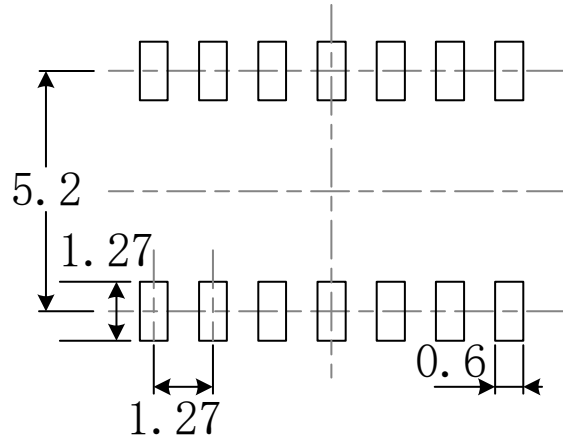
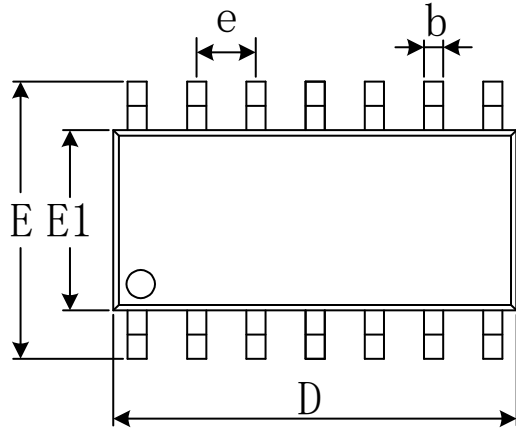

RECOMMENDED LAND PATTERN (Unit: mm)

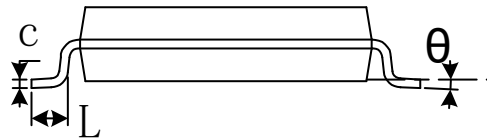
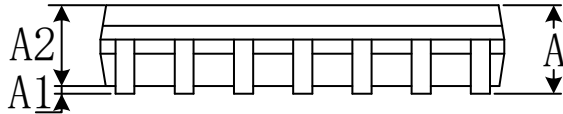

Symbol	Dimensions In Millimeters		Dimensions In Inches	
	Min	Max	Min	Max
A	1.350	1.750	0.053	0.069
A1	0.100	0.250	0.004	0.010
A2	1.350	1.550	0.053	0.061
b	0.310	0.510	0.012	0.020
c	0.100	0.250	0.004	0.010
D	8.450	8.850	0.333	0.348
e	1.270(BSC)		0.050(BSC)	
E	5.800	6.200	0.228	0.244
E1	3.800	4.000	0.150	0.157
L	0.400	1.270	0.016	0.050
θ	0°	8°	0°	8°

TDFN-3x3-8L

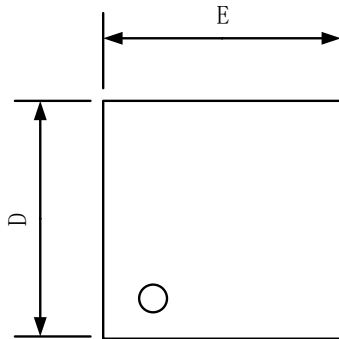

TOP VIEW

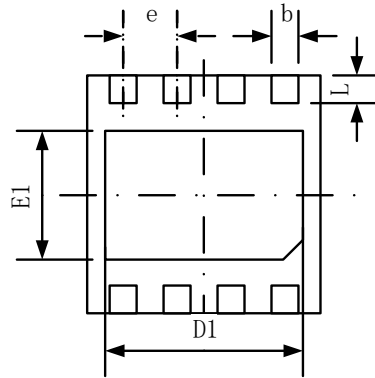

BOTTOM VIEW

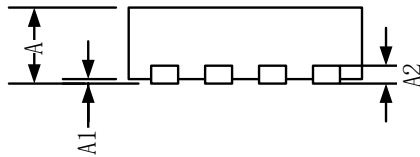

SIDE VIEW

Symbol	Dimensions In Millimeters		Dimensions In Inches	
	Min	Max	Min	Max
A	0.700	0.800	0.028	0.031
A1	0.000	0.050	0.000	0.002
A2	0.203		0.008	
b	0.300	0.400	0.012	0.016
D	2.900	3.100	0.114	0.122
D1	2.510	2.610	0.099	0.103
E	2.900	3.100	0.114	0.122
E1	1.550	1.650	0.061	0.065
e	0.650 TYP		0.026 TYP	
L	0.350	0.450	0.014	0.018