

P-Ch 20V Fast Switching MOSFETs
Description

The HSM2627 is the high cell density trenched P-ch MOSFETs, which provide excellent R_{DS(ON)} and gate charge for most of the synchronous buck converter applications.

The HSM2627 meet the RoHS and Green Product requirement with full function reliability approved.

- Super Low Gate Charge
- Green Device Available
- Excellent CdV/dt effect decline
- Advanced high cell density Trench technology

Product Summary

V _{DS}	-20	V
R _{DS(ON),max}	9	mΩ
I _D	-10.7	A

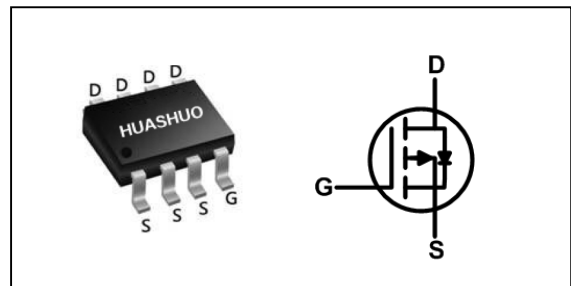
SOP8 Pin Configuration

Absolute Maximum Ratings

Symbol	Parameter	Rating		Units
		10s	Steady State	
V _{DS}	Drain-Source Voltage	-20		V
V _{GS}	Gate-Source Voltage	±8		V
I _D @T _A =25°C	Continuous Drain Current, V _{GS} @ -4.5V ¹	-14	-10.7	A
I _D @T _A =70°C	Continuous Drain Current, V _{GS} @ -4.5V ¹	-11.2	-8.6	A
I _{DM}	Pulsed Drain Current ²	-60		A
P _D @T _A =25°C	Total Power Dissipation ³	2.5	1.5	W
P _D @T _A =70°C	Total Power Dissipation ³	1.6	0.94	W
T _{STG}	Storage Temperature Range	-55 to 150		°C
T _J	Operating Junction Temperature Range	-55 to 150		°C

Thermal Data

Symbol	Parameter	Typ.	Max.	Unit
R _{θJA}	Thermal Resistance Junction-Ambient ¹	---	85	°C/W
R _{θJA}	Thermal Resistance Junction-Ambient ¹ (t ≤ 10s)	---	50	°C/W
R _{θJC}	Thermal Resistance Junction-Case ¹	---	24	°C/W



Electrical Characteristics ($T_J=25\text{ }^\circ\text{C}$, unless otherwise noted)

Symbol	Parameter	Conditions	Min.	Typ.	Max.	Unit
BV_{DSS}	Drain-Source Breakdown Voltage	$V_{GS}=0V, I_D=-250\mu A$	-20	---	---	V
$\Delta BV_{DSS}/\Delta T_J$	BV_{DSS} Temperature Coefficient	Reference to 25°C , $I_D=-1\text{mA}$	---	-0.012	---	$V/^\circ\text{C}$
$R_{DS(ON)}$	Static Drain-Source On-Resistance ²	$V_{GS}=-4.5V, I_D=-10A$	---	---	9	m Ω
		$V_{GS}=-2.5V, I_D=-8A$	---	---	11.5	
		$V_{GS}=-1.8V, I_D=-6A$	---	---	17	
$V_{GS(th)}$	Gate Threshold Voltage	$V_{GS}=V_{DS}, I_D=-250\mu A$	-0.3	---	-1.0	V
$\Delta V_{GS(th)}$	$V_{GS(th)}$ Temperature Coefficient		---	2.94	---	$\text{mV}/^\circ\text{C}$
I_{DSS}	Drain-Source Leakage Current	$V_{DS}=-20V, V_{GS}=0V, T_J=25^\circ\text{C}$	---	---	1	μA
I_{GSS}	Gate-Source Leakage Current	$V_{GS}=\pm 8V, V_{DS}=0V$	---	---	± 100	nA
gfs	Forward Transconductance	$V_{DS}=-5V, I_D=-10A$	---	43	---	S
Q_g	Total Gate Charge (-4.5V)	$V_{DS}=-15V, V_{GS}=-4.5V, I_D=-10A$	---	63	---	nC
Q_{gs}	Gate-Source Charge		---	9.1	---	
Q_{gd}	Gate-Drain Charge		---	13	---	
$T_{d(on)}$	Turn-On Delay Time	$V_{DD}=-10V, V_{GS}=-4.5V,$ $R_G=3.3\Omega, I_D=-10A$	---	15.8	---	ns
T_r	Rise Time		---	76.8	---	
$T_{d(off)}$	Turn-Off Delay Time		---	193	---	
T_f	Fall Time		---	186.4	---	
C_{iss}	Input Capacitance	$V_{DS}=-15V, V_{GS}=0V, f=1\text{MHz}$	---	5783	---	pF
C_{oss}	Output Capacitance		---	509	---	
C_{rss}	Reverse Transfer Capacitance		---	431	---	

Diode Characteristics

Symbol	Parameter	Conditions	Min.	Typ.	Max.	Unit
I_S	Continuous Source Current ^{1,4}	$V_G=V_D=0V$, Force Current	---	---	-10.7	A
I_{SM}	Pulsed Source Current ^{2,4}		---	---	-60	A
V_{SD}	Diode Forward Voltage ²	$V_{GS}=0V, I_S=-1A, T_J=25^\circ\text{C}$	---	---	-1.2	V
t_{rr}	Reverse Recovery Time	$I_F=-10A, dI/dt=100A/\mu s,$ $T_J=25^\circ\text{C}$	---	27	---	nS
Q_{rr}	Reverse Recovery Charge		---	17.8	---	nC

Note :

- 1.The data tested by surface mounted on a 1 inch² FR-4 board with 20Z copper.
- 2.The data tested by pulsed , pulse width $\leq 300\mu s$, duty cycle $\leq 2\%$
- 3.The power dissipation is limited by 150°C junction temperature
- 4.The data is theoretically the same as I_D and I_{DM} , in real applications , should be limited by total power dissipation.



Typical Characteristics

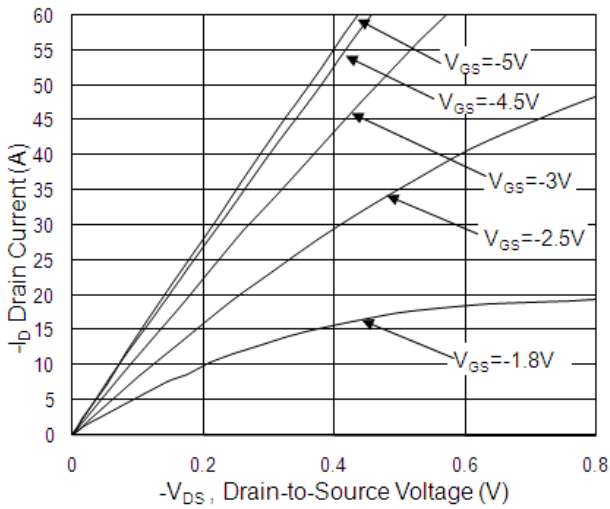

Fig.1 Typical Output Characteristics

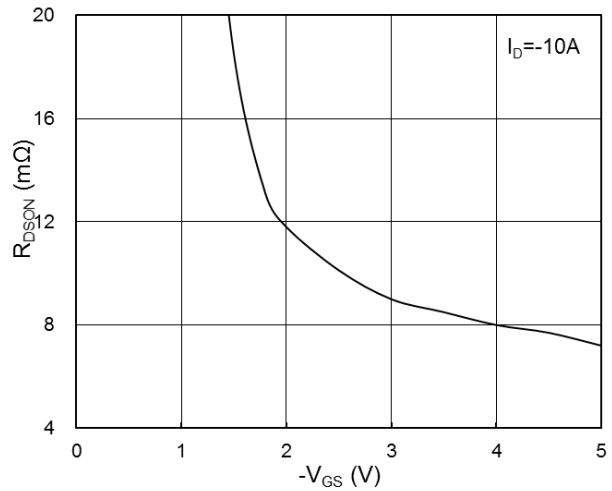

Fig.2 On-Resistance vs. G-S Voltage

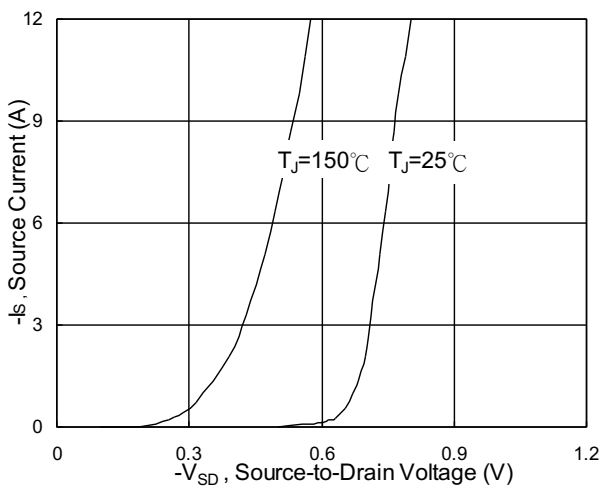

Fig.3 Source Drain Forward Characteristics

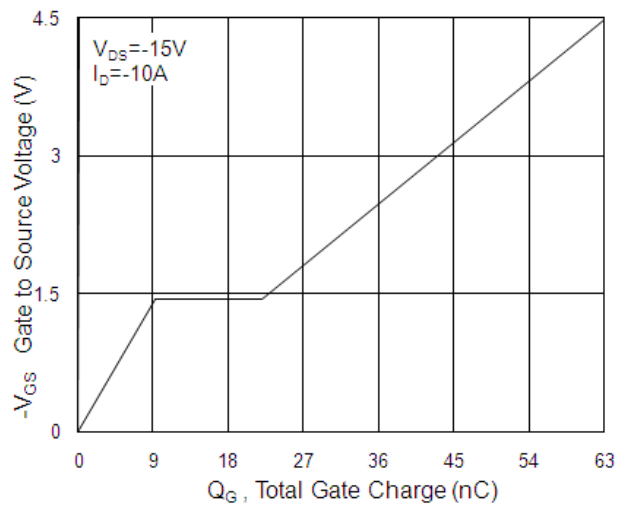

Fig.4 Gate-charge Characteristics

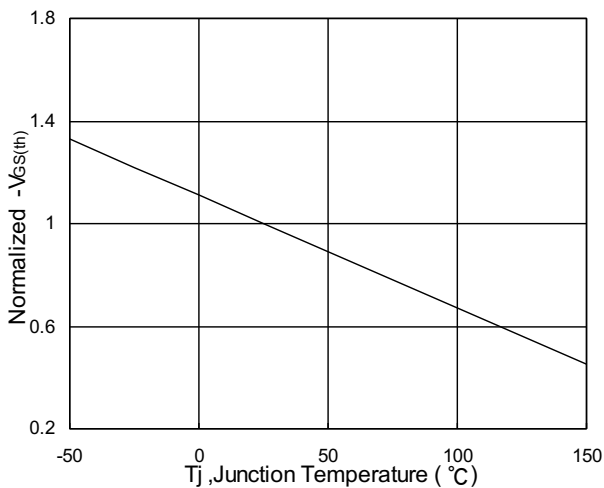

Fig.5 Normalized $V_{GS(th)}$ vs. T_J

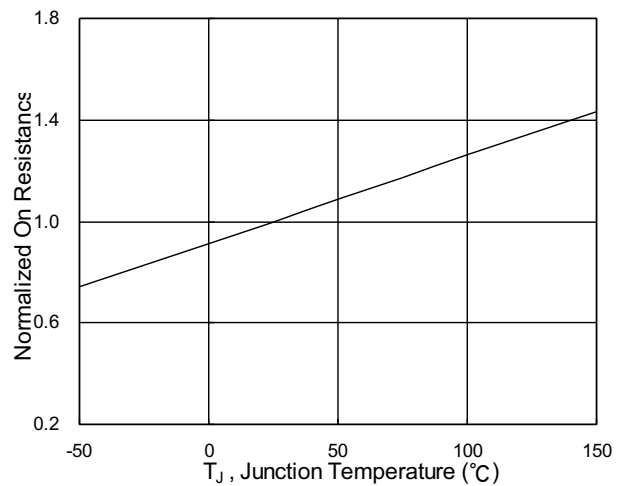

Fig.6 Normalized $R_{DS(ON)}$ vs. T_J



P-Ch 20V Fast Switching MOSFETs

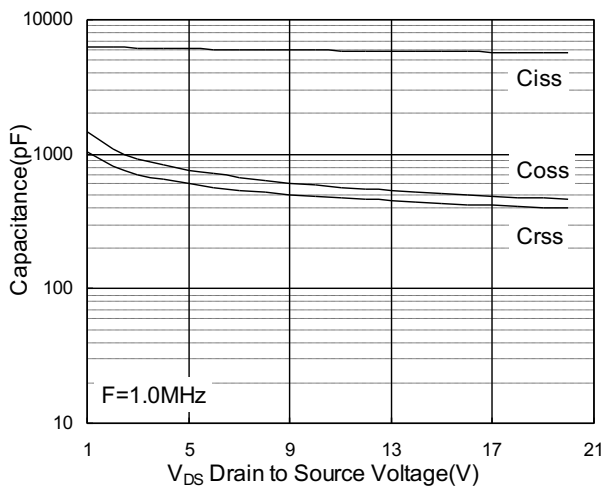

Fig.7 Capacitance

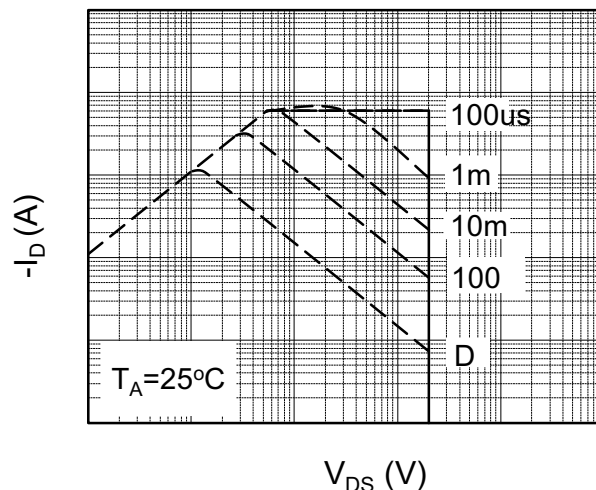

Fig.8 Safe Operating Area

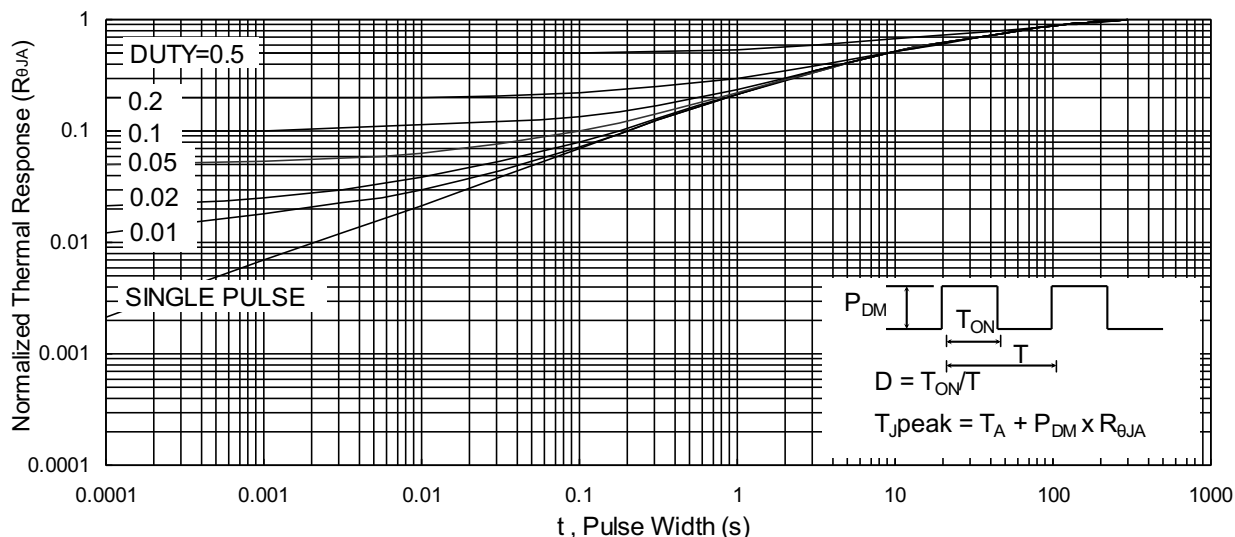

Fig.9 Normalized Maximum Transient Thermal Impedance

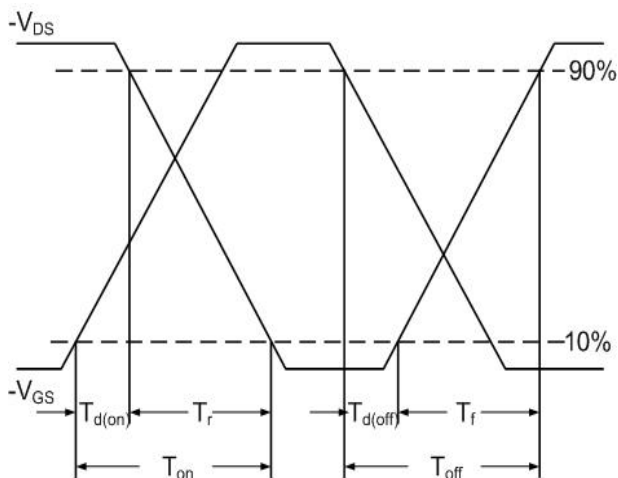

Fig.10 Switching Time Waveform

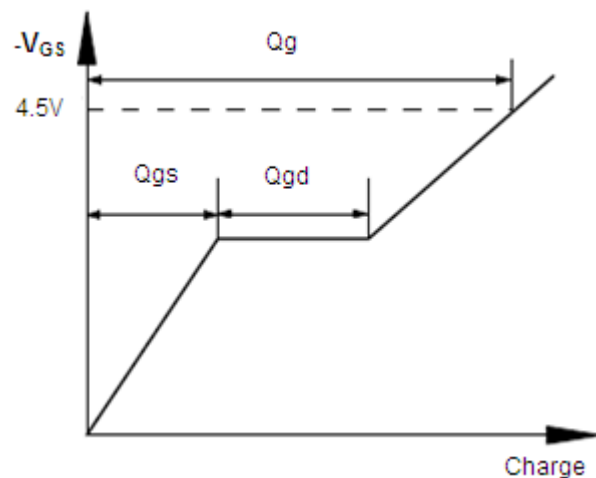

Fig.11 Gate Charge Waveform



Ordering Information

Part Number	Package code	Packaging
HSM2627	SOP-8	2500/Tape&Reel

