

Description

The HSH90P06 is the high cell density trenched P-ch MOSFETs, which provide excellent RDSON and gate charge for most of the synchronous buck converter applications.

The HSH90P06 meet the RoHS and Green Product requirement, 100% EAS guaranteed with full function reliability approved.

- 100% EAS Guaranteed
- Green Device Available
- Super Low Gate Charge
- Excellent CdV/dt effect decline
- Advanced high cell density Trench technology

Product Summary

V _{DS}	-60	V
R _{DS(ON),typ}	7.5	mΩ
I _D	-85	A

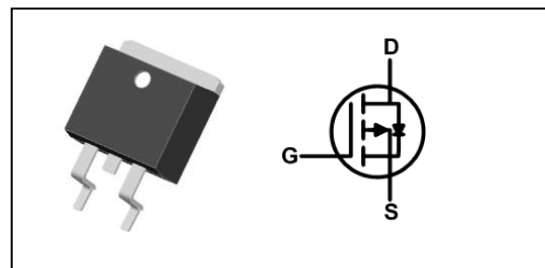
TO263 Pin Configuration

Absolute Maximum Ratings

Symbol	Parameter	Rating	Units
V _{DS}	Drain-Source Voltage	-60	V
V _{GS}	Gate-Source Voltage	±20	V
I _D @T _C =25°C	Continuous Drain Current ¹	-85	A
I _D @T _C =100°C	Continuous Drain Current ¹	-60	A
I _{DM}	Pulsed Drain Current ²	-310	A
EAS	Single Pulse Avalanche Energy ³	360	mJ
P _D @T _C =25°C	Total Power Dissipation ⁴	210	W
T _{STG}	Storage Temperature Range	-55 to 150	°C
T _J	Operating Junction Temperature Range	-55 to 150	°C

Thermal Data

Symbol	Parameter	Typ.	Max.	Unit
R _{θJA}	Thermal Resistance Junction-Ambient ¹	---	62	°C/W
R _{θJC}	Thermal Resistance Junction-Case ¹	---	0.71	°C/W

Electrical Characteristics (T_J=25 °C, unless otherwise noted)

Symbol	Parameter	Conditions	Min.	Typ.	Max.	Unit
B _{VDS}	Drain-Source Breakdown Voltage	V _{GS} =0V, I _D =-250uA	-60	---	---	V
R _{DS(ON)}	Static Drain-Source On-Resistance ²	V _{GS} =-10V, I _D =-40A	---	7.5	9	mΩ
		V _{GS} =-4.5V, I _D =-30A	---	9	11	
V _{GS(th)}	Gate Threshold Voltage	V _{GS} =V _{DS} , I _D =-250uA	-1.0	-1.4	-3.0	V
I _{DSS}	Drain-Source Leakage Current	V _{DS} =-48V, V _{GS} =0V, T _J =25°C	---	---	1	uA
		V _{DS} =-48V, V _{GS} =0V, T _J =55°C	---	---	50	
I _{GSS}	Gate-Source Leakage Current	V _{GS} =±20V, V _{DS} =0V	---	---	±100	nA
R _g	Gate Resistance	V _{DS} =0V, V _{GS} =0V, f=1MHz	---	3.4	---	Ω
Q _g	Total Gate Charge (-4.5V)	V _{DS} =-48V, V _{GS} =-10V, I _D =-40A	---	170	---	nC
Q _{gs}	Gate-Source Charge		---	29	---	
Q _{gd}	Gate-Drain Charge		---	35	---	
T _{d(on)}	Turn-On Delay Time	V _{DD} =-30V, V _{GS} =-10V, R _G =4Ω, I _D =-40A	---	15	---	ns
T _r	Rise Time		---	88	---	
T _{d(off)}	Turn-Off Delay Time		---	150	---	
T _f	Fall Time		---	101	---	
C _{iss}	Input Capacitance	V _{DS} =-25V, V _{GS} =0V, f=1MHz	---	9188	---	pF
C _{oss}	Output Capacitance		---	501	---	
C _{rss}	Reverse Transfer Capacitance		---	234	---	

Diode Characteristics

Symbol	Parameter	Conditions	Min.	Typ.	Max.	Unit
I _S	Continuous Source Current ^{1,5}	V _G =V _D =0V, Force Current	---	---	-85	A
V _{SD}	Diode Forward Voltage ²	V _{GS} =0V, I _S =-40A, T _J =25°C	---	---	-1.3	V
T _{rr}	Reverse Recovery Time	I _{sd} =-40A, dI/dt=100A/us	---	21	---	ns
Q _{rr}	Reverse Recovery Charge		---	17	---	nC

Note :

- 1.The data tested by surface mounted on a 1 inch² FR-4 board with 2OZ copper.
- 2.The data tested by pulsed, pulse width ≤ 300us, duty cycle ≤ 2%
- 3.The EAS data shows Max. rating. The test condition is V_{DD}=-48V, V_{GS}=-10V, L=0.3mH
- 4.The power dissipation is limited by 150°C junction temperature
- 5.The data is theoretically the same as I_D and I_{DM}, in real applications, should be limited by total power dissipation.

Typical Characteristics

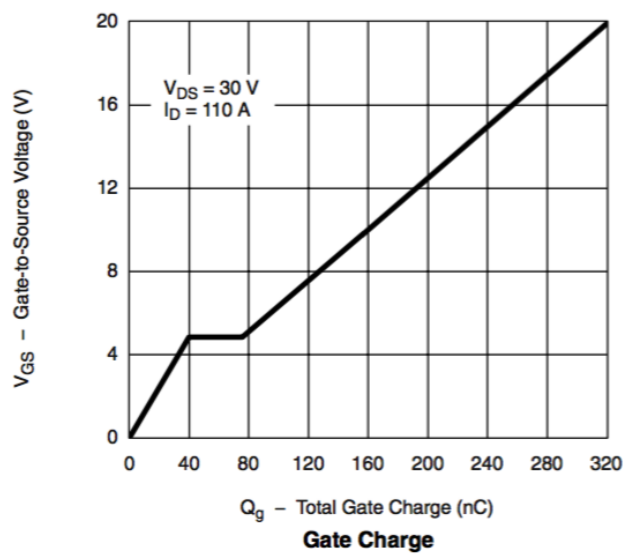
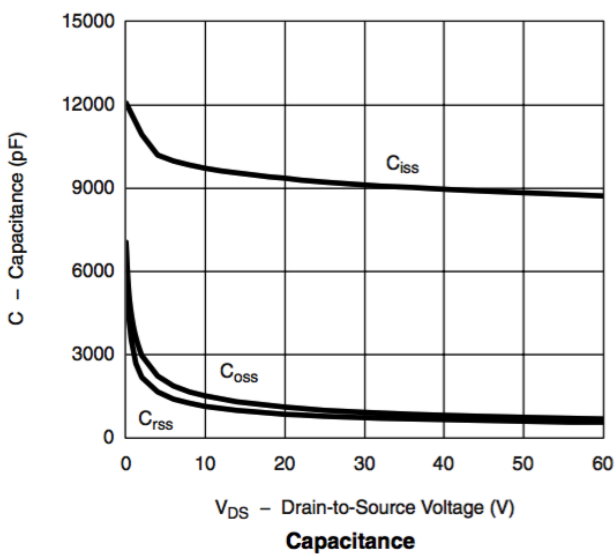
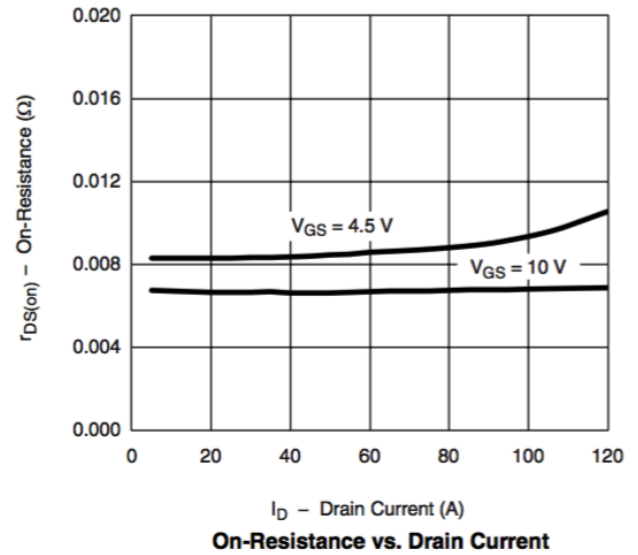
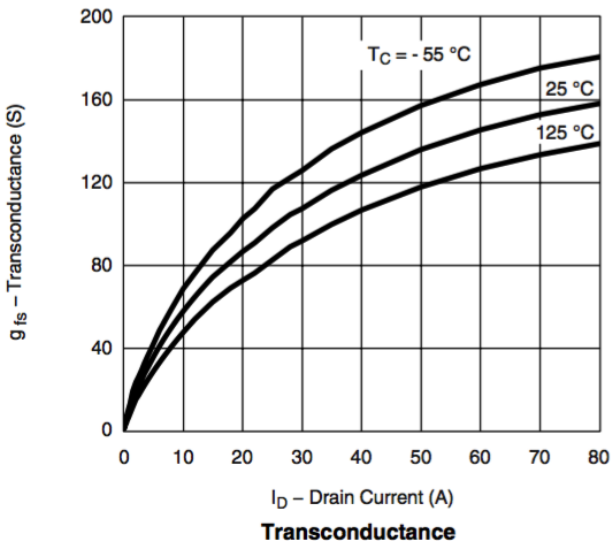
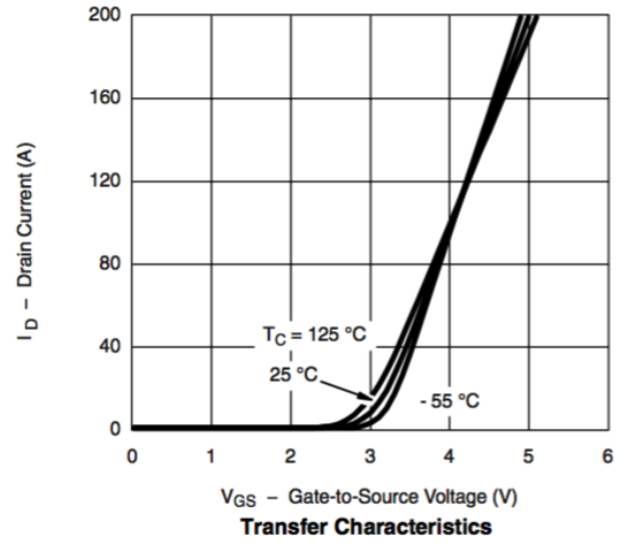
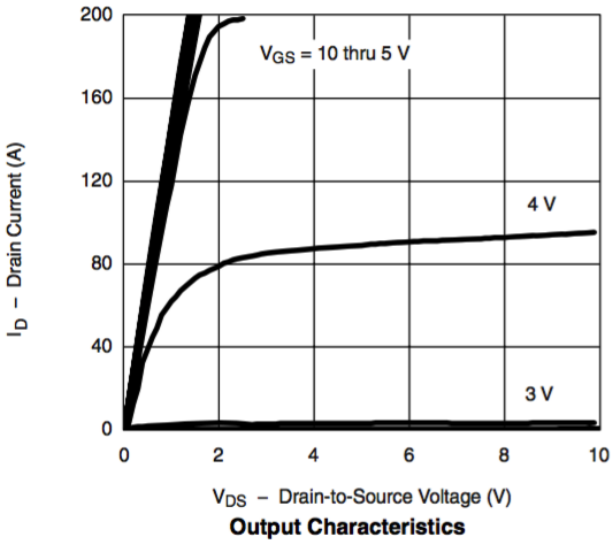

P-Ch 60V Fast Switching MOSFETs

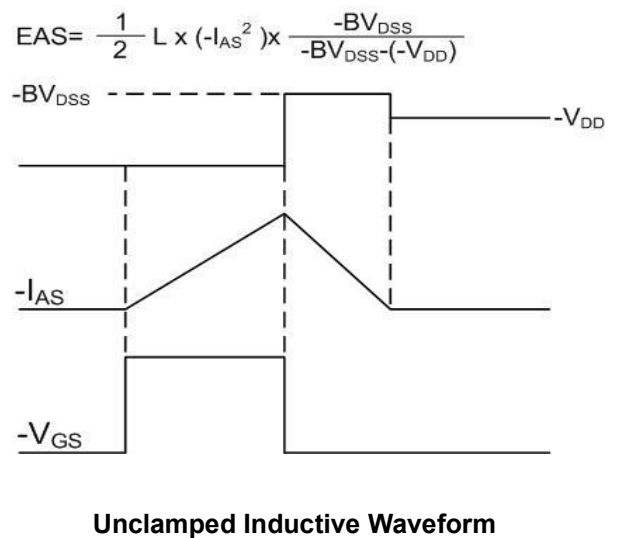
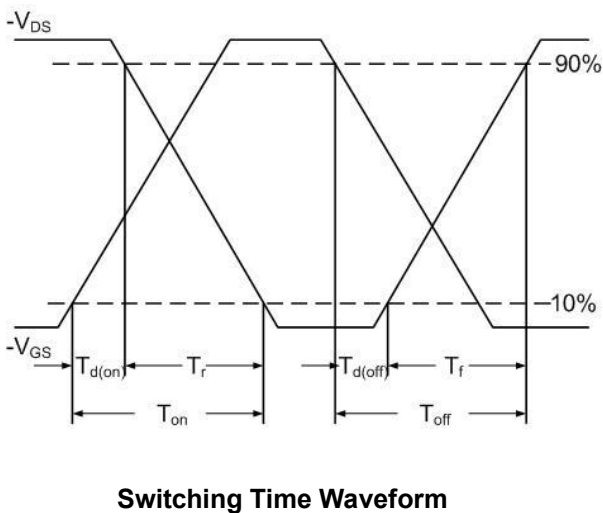
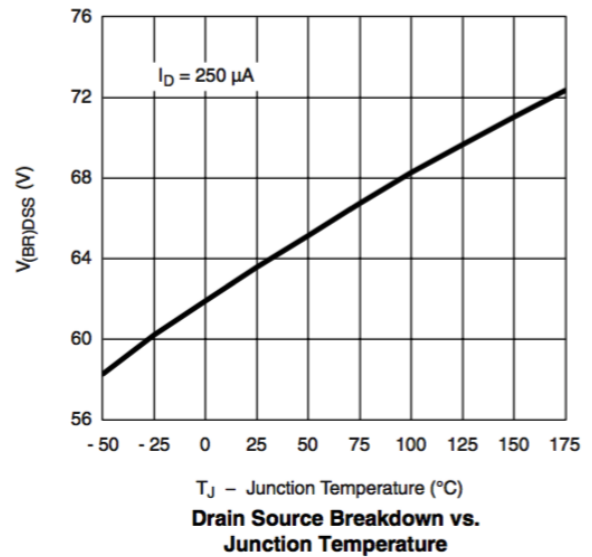
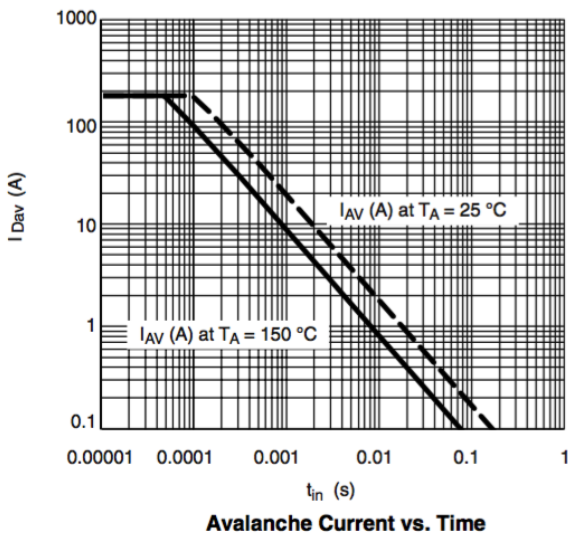
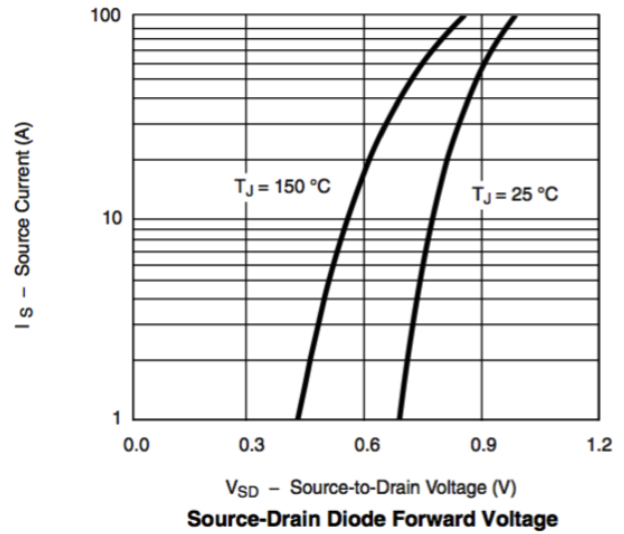
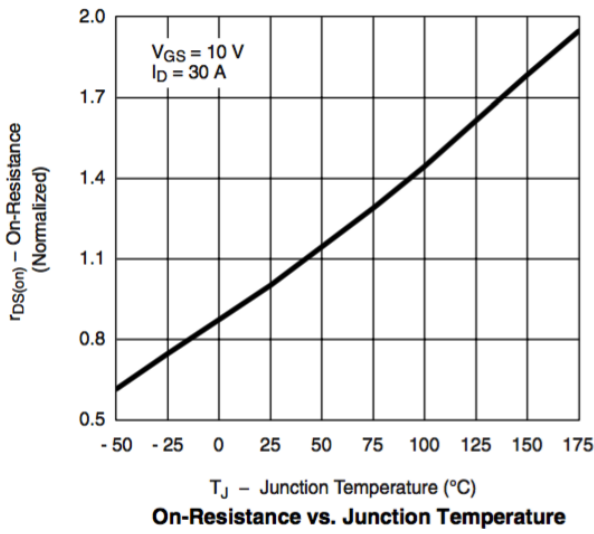

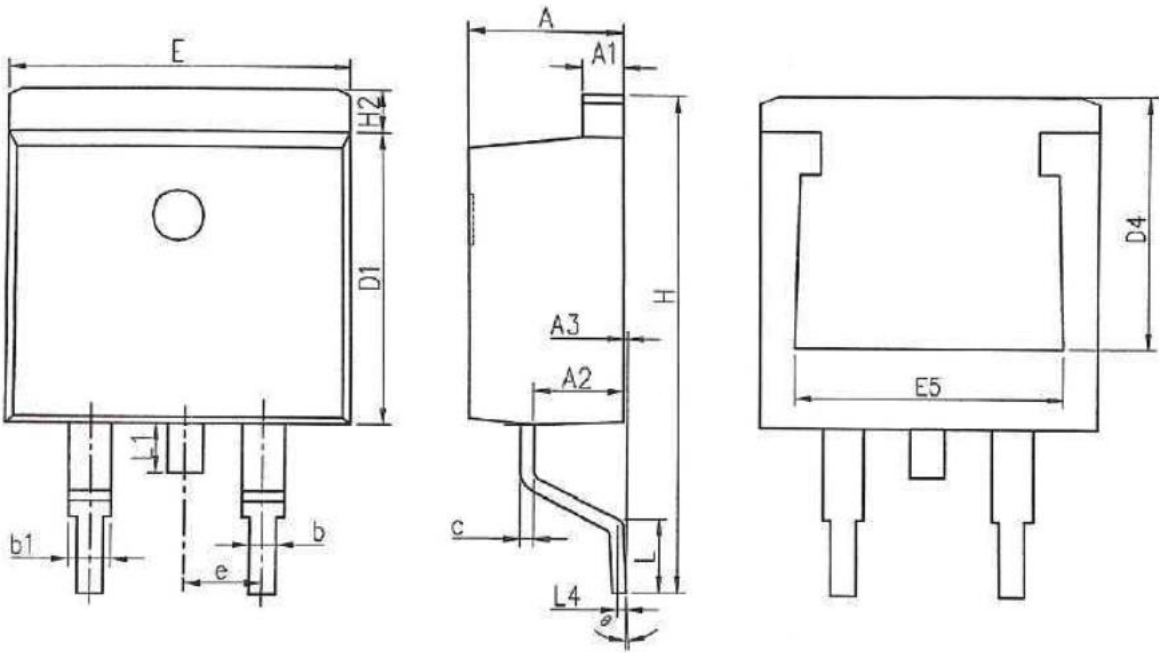

SYMBOLS	MILLIMETERS		INCHES	
	MIN	MAX	MIN	MAX
A	4.370	4.770	0.172	0.188
A1	1.220	1.420	0.048	0.056
A2	2.200	2.890	0.087	0.114
A3	0.000	0.250	0.000	0.010
b	0.700	0.960	0.028	0.038
b1	1.170	1.470	0.046	0.058
c	0.300	0.530	0.012	0.021
D1	8.500	9.300	0.335	0.366
D4	6.600	-	0.260	-
E	9.860	10.36	0.388	0.408
E5	7.060	-	0.278	-
e	2.540 BSC		0.100 BSC	
H	14.70	15.70	0.579	0.618
H2	1.070	1.470	0.042	0.058
L	2.000	2.600	0.079	0.102
L1	1.400	1.750	0.055	0.069
L4	0.250 BSC		0.010 BSC	
Θ	0°	9°	0°	9°