

Specifications

- Current rating:3A AC,DC
- Voltage rating:250V AC,DC
- Temperature range:-40°C~+105°C
- Contact resistance:10mΩMax.
- Insulation resistance:1000MΩMin.
- Withstanding voltage:800V AC/minute
- *Compliant with RoHS and REACH*
- *Meet the HF/Halogen Free,need to customize*
- *Contact CJT for details*

Standards



Assembly layout

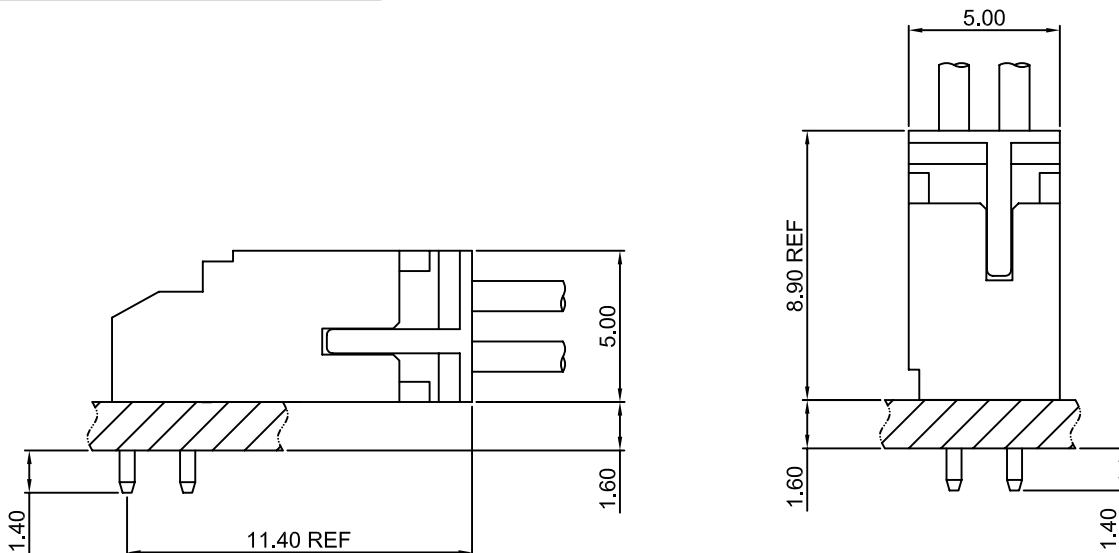

A2006-T

2.00mm pitch Crimp Terminal

Reference Informations:

*Used in CJT A2006 series Housing

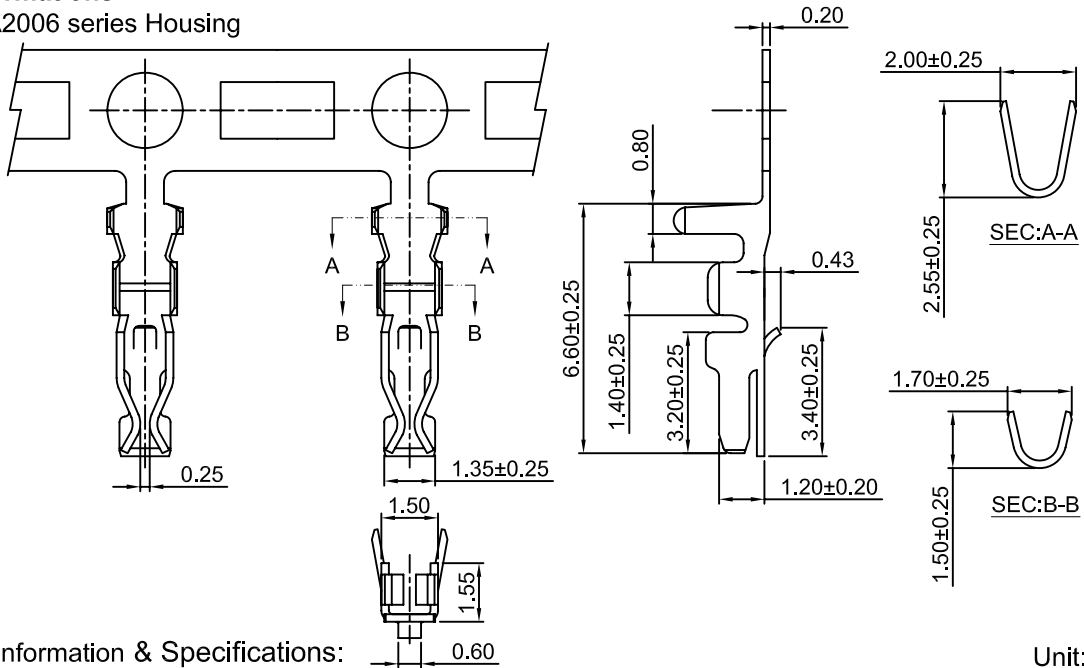

Ordering information & Specifications:

Unit:mm

Part NO.	Wire Range	Insulation O.D.	Material	Finish	Qty/reel
A2006-TP	AWG#22-#28	1.50mm(max)	Phosphor Bronze	Tin over Nickel	10,000 PCS
A2006-GP	AWG#22-#28	1.50mm(max)	Phosphor Bronze	Gold over flash	10,000 PCS

Optional Gold plating available but MOQ requested

A2006-T-B

2.00mm pitch Crimp Terminal

Reference Informations:

*Used in CJT A2006HB series Housing

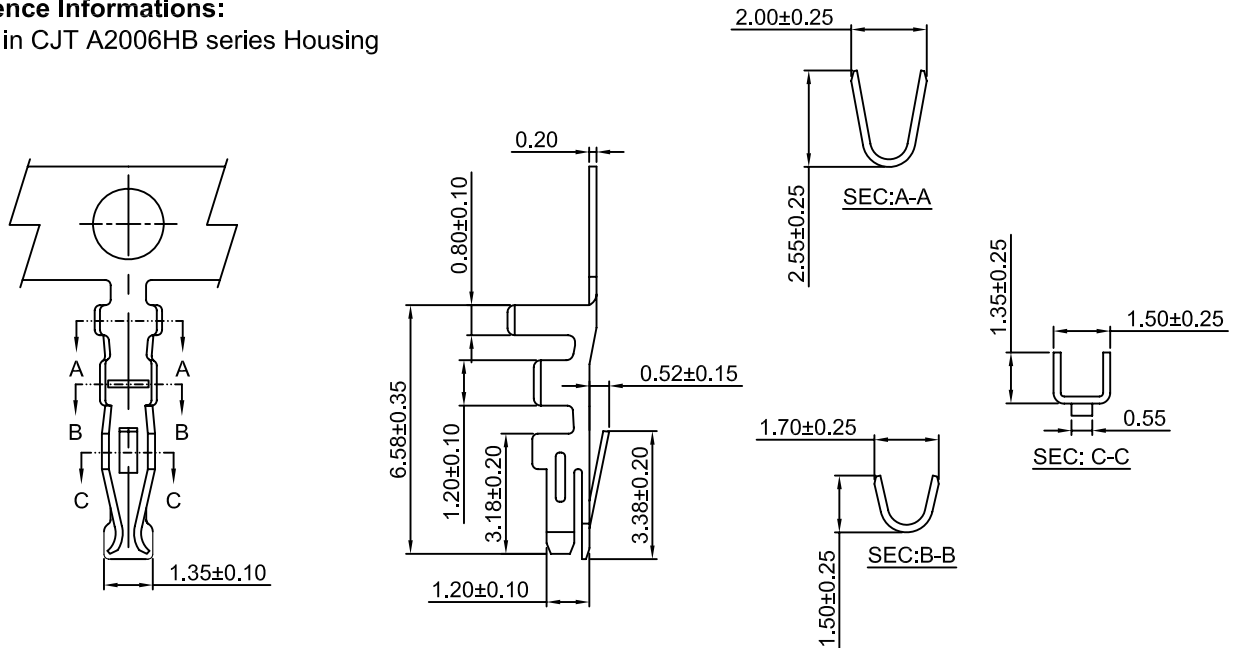

Ordering information & Specifications:

Unit:mm

Part NO.	Wire Range	Insulation O.D.	Material	Finish	Qty/reel
A2006-TP-B	AWG#22-#28	1.50mm(max)	Phosphor Bronze	Tin over Nickel	10,000 PCS
A2006-GP-B	AWG#22-#28	1.50mm(max)	Phosphor Bronze	Gold over flash	10,000 PCS

Optional Gold plating available but MOQ requested

CJTconn A2006 SERIES

2.00mm pitch wire to board connector

A2006-T-U

2.00mm pitch Crimp Terminal

Reference Informations:

*Used in CJT A2006HU series Housing

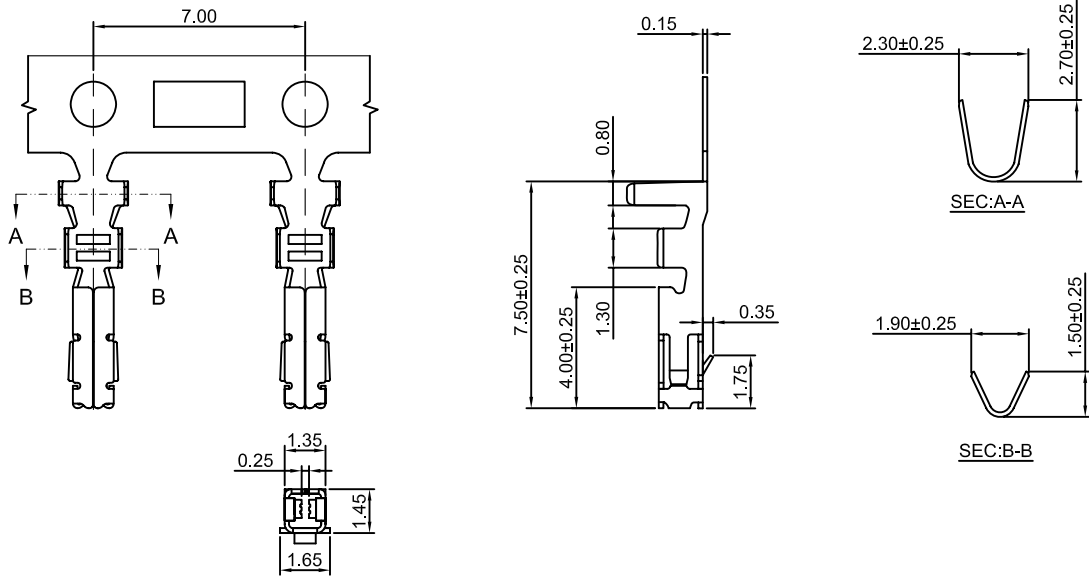

Ordering information & Specifications:

Unit:mm

Part NO.	Wire Range	Insulation O.D.	Material	Finish	Qty/reel
A2006-TP-U	AWG#22-#28	1.50mm(max)	Phosphor Bronze	Tin over Nickel	10,000 PCS
A2006-GP-U	AWG#22-#28	1.50mm(max)	Phosphor Bronze	Gold over flash	10,000 PCS

Optional Gold plating available but MOQ requested

A2006H-2xXP

2.00mm pitch Dual Row Housing

Reference Informations:

*Material:Nylon 66,UL94V-0

*Suitable CJT A2006 series Terminal

*Mates with CJT A2006 series Dual Row Wafer

*Color:White

Ordering Information:

A2006H-2xXP - **
1 2

1.Part No.

2.Color

(blank) :White

BK :Black

Ordering Information & Dimensions:

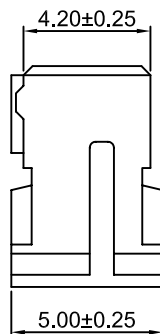
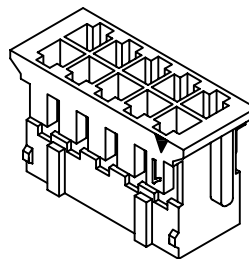
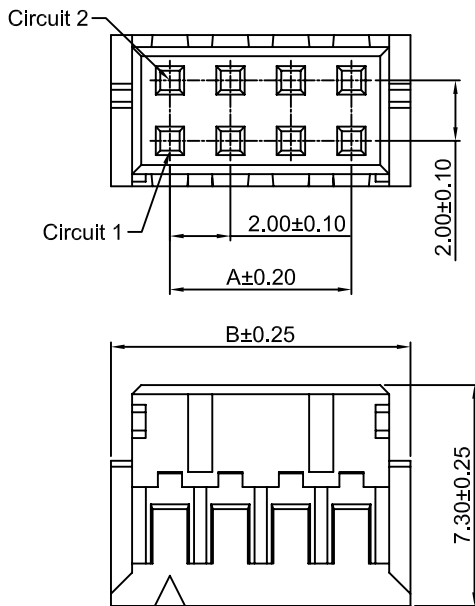

PART NO.	Dimensions	
	A	B
2x2P	2.00	5.90
2x3P	4.00	7.90
2x4P	6.00	9.90
2x5P	8.00	11.90
2x6P	10.00	13.90
2x7P	12.00	15.90
2x8P	14.00	17.90
2x9P	16.00	19.90
2x10P	18.00	21.90
2x11P	20.00	23.90
2x12P	22.00	25.90
2x13P	24.00	27.90
2x14P	26.00	29.90
2x15P	28.00	31.90
2x16P	30.00	33.90
2x17P	32.00	35.90
2x18P	34.00	37.90
2x19P	36.00	39.90
2x20P	38.00	41.90
2x21P	40.00	43.90
2x22P	42.00	45.90
2x23P	44.00	47.90
2x24P	46.00	49.90
2x25P	48.00	51.90

Unit: mm

CJTconn A2006 SERIES

2.00mm pitch wire to board connector

A2006HA-2xXP

2.00mm pitch Dual Row Housing

Reference Informations:

- *Material:Nylon 66,UL94V-0
- *Suitable CJT A2006 series Terminal
- *Mates with CJT A2006 series Dual Row Wafer
- *Color:White

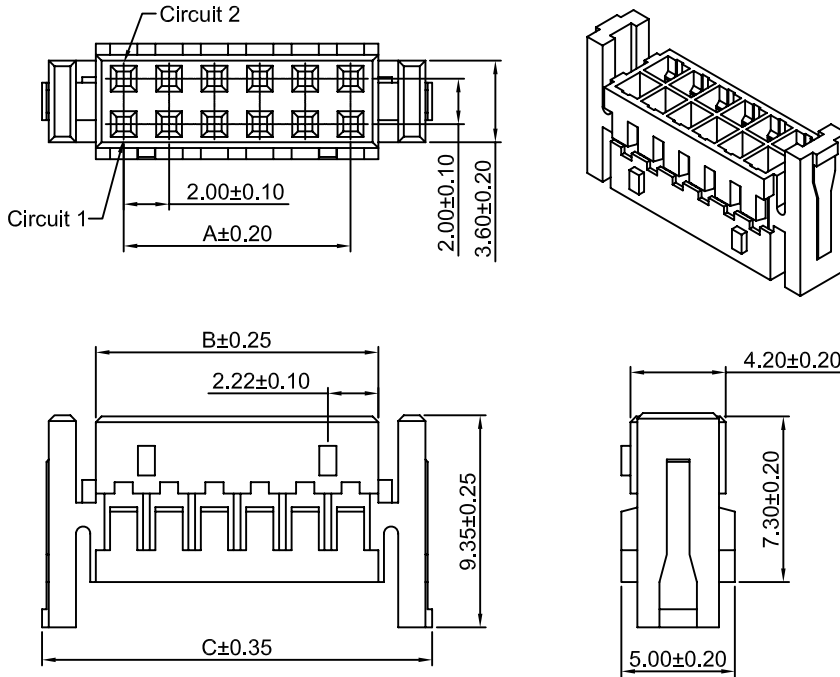

Ordering Information & Dimensions:

PART NO.	Dimensions		
	A	B	C
2x3P	4.00	6.45	11.60
2x4P	6.00	8.45	13.60
2x5P	8.00	10.45	15.60
2x6P	10.00	12.45	17.60
2x7P	12.00	14.45	19.60
2x8P	14.00	16.45	21.60
2x9P	16.00	18.45	23.60
2x10P	18.00	20.45	25.60
2x11P	20.00	22.45	27.60
2x12P	22.00	24.45	29.60
2x13P	24.00	26.45	31.60
2x14P	26.00	28.45	33.60
2x15P	28.00	30.45	35.60
2x16P	30.00	32.45	37.60
2x17P	32.00	34.45	39.60
2x18P	34.00	36.45	41.60
2x19P	36.00	38.45	43.60
2x20P	38.00	40.45	45.60

Unit: mm

A2006HB-2xXP

2.00mm pitch Dual Row Housing

Reference Informations:

- *Material:Nylon 66,UL94V-0
- *Suitable CJT A2006-T-B series Terminal
- *Mates with CJT A2006WVB , A2006WRB series Dual Row Wafer
- *Color:White

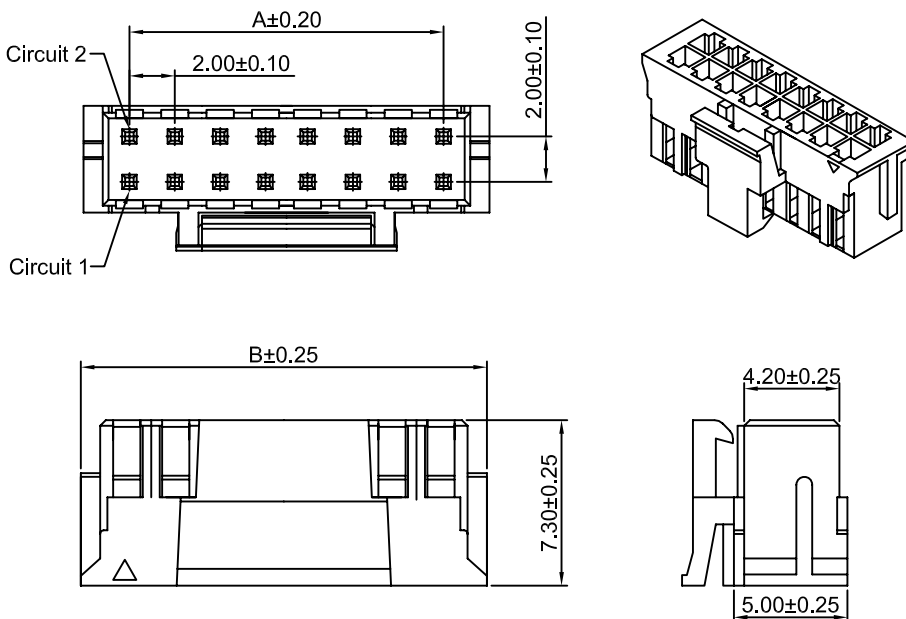

Ordering Information & Dimensions:

PART NO.	Dimensions	
	A	B
2x2P	2.00	5.90
2x3P	4.00	7.90
2x4P	6.00	9.90
2x5P	8.00	11.90
2x6P	10.00	13.90
2x7P	12.00	15.90
2x8P	14.00	17.90
2x9P	16.00	19.90
2x10P	18.00	21.90
2x11P	20.00	23.90
2x12P	22.00	25.90
2x13P	24.00	27.90
2x14P	26.00	29.90
2x15P	28.00	31.90
2x16P	30.00	33.90
2x17P	32.00	35.90
2x18P	34.00	37.90
2x19P	36.00	39.90
2x20P	38.00	41.90
2x21P	40.00	43.90
2x22P	42.00	45.90

Unit: mm

CJTconn A2006 SERIES

2.00mm pitch wire to board connector

A2006HU-2xXP

2.00mm pitch Dual Row Housing

Reference Informations:

- *Material:Nylon 66,UL94V-0
- *Suitable CJT A2006-T-U series Terminal
- *Mates with CJT A2006WVU,WRU series Dual Row Wafer
- *Color:Natural

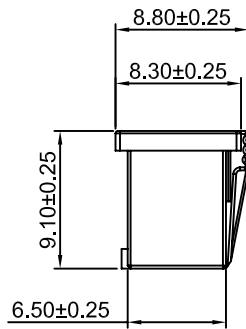
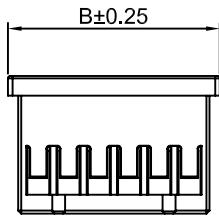
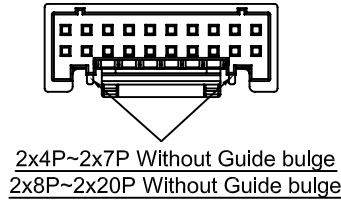
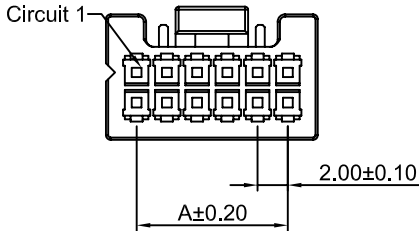
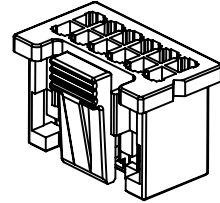

Ordering Information & Dimensions:

PART NO.	Dimensions	
	A	B
2x4P	6.00	10.00
2x5P	8.00	12.00
2x6P	10.00	14.00
2x7P	12.00	16.00
2x8P	14.00	18.00
2x9P	16.00	20.00
2x10P	18.00	22.00
2x11P	20.00	24.00
2x12P	22.00	26.00
2x13P	24.00	28.00
2x14P	26.00	30.00
2x15P	28.00	32.00
2x16P	30.00	34.00
2x17P	32.00	36.00
2x18P	34.00	38.00
2x19P	36.00	40.00
2x20P	38.00	42.00

Unit: mm

A2006WV-2xXP

2.00mm pitch 180° Dual Row Wafer

Reference Informations:

- *Material:Pin:Brass/Tin over Nickel
Insulator:Nylon 66,UL94V-0
- *Mates with CJT A2006 series Dual Row Housing
- *Color:Grey

Ordering Information:
A2006WV-2xXP - **

- 1.Part No.
- 2.Color
(blank) :Grey
BK :Black

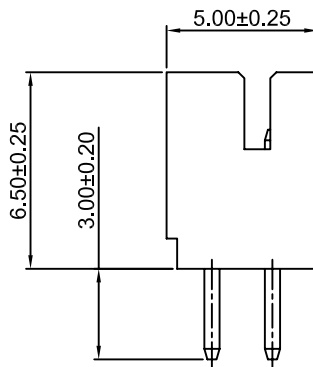
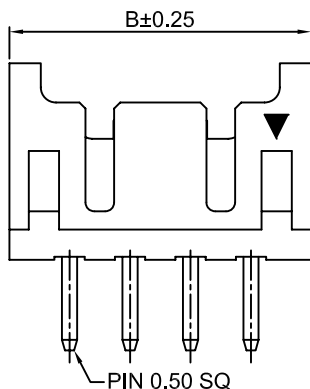
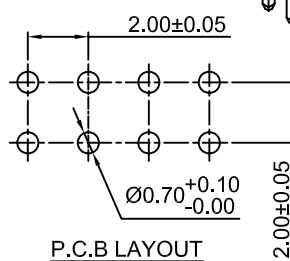
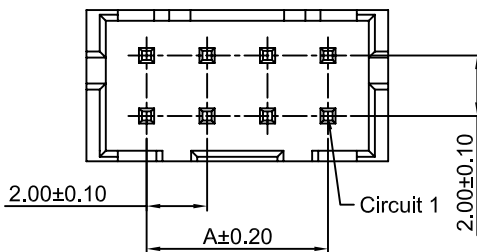
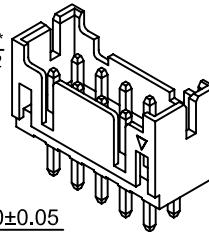

Ordering Information & Dimensions:

PART NO.	Dimensions	
	A	B
2x2P	2.00	5.90
2x3P	4.00	7.90
2x4P	6.00	9.90
2x5P	8.00	11.90
2x6P	10.00	13.90
2x7P	12.00	15.90
2x8P	14.00	17.90
2x9P	16.00	19.90
2x10P	18.00	21.90
2x11P	20.00	23.90
2x12P	22.00	25.90
2x13P	24.00	27.90
2x14P	26.00	29.90
2x15P	28.00	31.90
2x16P	30.00	33.90
2x17P	32.00	35.90
2x18P	34.00	37.90
2x19P	36.00	39.90
2x20P	38.00	41.90
2x21P	40.00	43.90
2x22P	42.00	45.90
2x23P	44.00	47.90
2x24P	46.00	49.90
2x25P	48.00	51.90

Unit: mm

CJTconn A2006 SERIES

2.00mm pitch wire to board connector

A2006WR-2xXP

2.00mm pitch 90° Dual Row Wafer

Reference Informations:

- *Material:Pin:Brass/Tin over Nickel
Insulator:Nylon 66,UL94V-0
- *Mates with CJT A2006 series Dual Row Housing
- *Color:Grey

Ordering Information:
A2006WR-2xXP - **
1
2
1.Part No.
2.Color
(blank):Grey
BK:Black

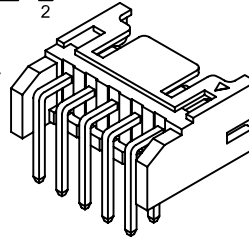

Ordering Information & Dimensions:

PART NO.	Dimensions	
	A	B
2x2P	2.00	5.90
2x3P	4.00	7.90
2x4P	6.00	9.90
2x5P	8.00	11.90
2x6P	10.00	13.90
2x7P	12.00	15.90
2x8P	14.00	17.90
2x9P	16.00	19.90
2x10P	18.00	21.90
2x11P	20.00	23.90
2x12P	22.00	25.90
2x13P	24.00	27.90
2x14P	26.00	29.90
2x15P	28.00	31.90
2x16P	30.00	33.90
2x17P	32.00	35.90
2x18P	34.00	37.90
2x19P	36.00	39.90
2x20P	38.00	41.90
2x21P	40.00	43.90
2x22P	42.00	45.90
2x23P	44.00	47.90
2x24P	46.00	49.90
2x25P	48.00	51.90

Unit: mm

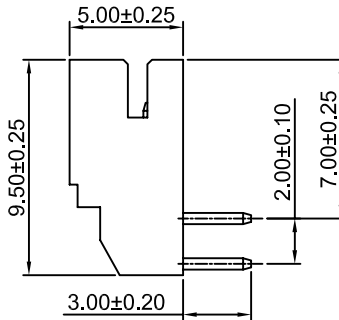
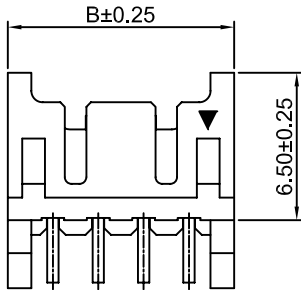
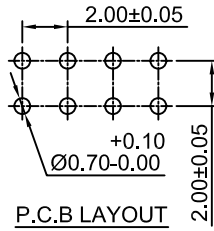
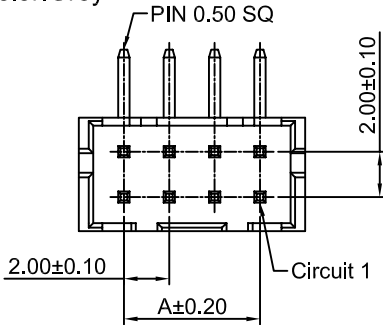

A2006WVA-2xXP

2.00mm pitch 180° Dual Row Wafer

Reference Informations:

- *Material:Pin:Brass/Tin over Nickel
Insulator:Nylon 66,UL94V-0
- *Mates with CJT A2006HA series Dual Row Housing
- *Color:Grey

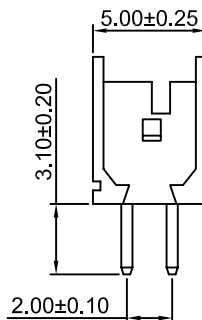
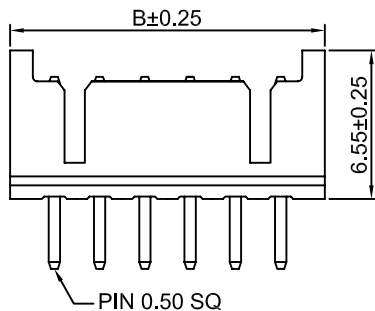
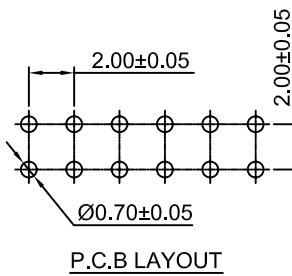
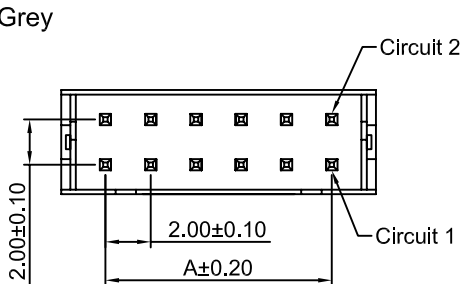

Ordering Information & Dimensions:

PART NO.	Dimensions	
	A	B
2x2P	2.00	8.00
2x3P	4.00	10.00
2x4P	6.00	12.00
2x5P	8.00	14.00
2x6P	10.00	16.00
2x7P	12.00	18.00
2x8P	14.00	20.00
2x9P	16.00	22.00
2x10P	18.00	24.00
2x11P	20.00	26.00
2x12P	22.00	28.00
2x13P	24.00	30.00
2x14P	26.00	32.00
2x15P	28.00	34.00
2x16P	30.00	36.00
2x17P	32.00	38.00
2x18P	34.00	40.00
2x19P	36.00	42.00
2x20P	38.00	44.00

Unit: mm

CJTconn A2006 SERIES

2.00mm pitch wire to board connector

A2006WRA-2xXP

2.00mm pitch 90° Dual Row Wafer

Reference Informations:

- *Material:Pin:Brass/Tin over Nickel
Insulator:Nylon 66,UL94V-0
- *Mates with CJT A2006HA series Dual Row Housing
- *Color:Grey

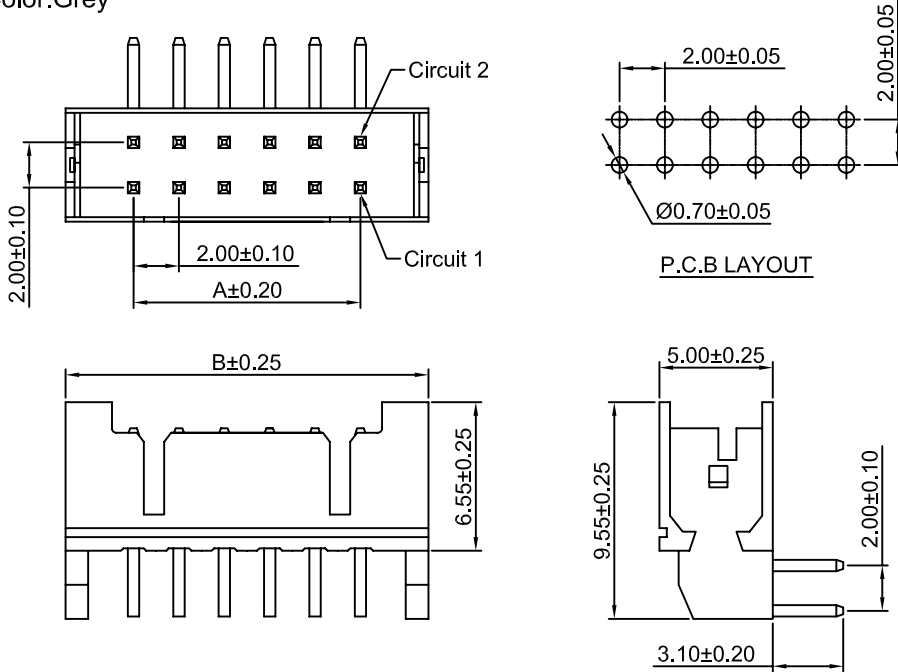

Ordering Information & Dimensions:

PART NO.	Dimensions	
	A	B
2x2P	2.00	8.00
2x3P	4.00	10.00
2x4P	6.00	12.00
2x5P	8.00	14.00
2x6P	10.00	16.00
2x7P	12.00	18.00
2x8P	14.00	20.00
2x9P	16.00	22.00
2x10P	18.00	24.00
2x11P	20.00	26.00
2x12P	22.00	28.00
2x13P	24.00	30.00
2x14P	26.00	32.00
2x15P	28.00	34.00
2x16P	30.00	36.00
2x17P	32.00	38.00
2x18P	34.00	40.00
2x19P	36.00	42.00
2x20P	38.00	44.00

Unit: mm

A2006WVB-2xXP

2.00mm pitch 180° Dual Row Wafer

Reference Informations:

- *Material:Pin:Brass/Tin over Nickel
Insulator:Nylon 66,UL94V-0
- *Mates with CJT A2006HB series Dual Row Housing
- *Color:Grey

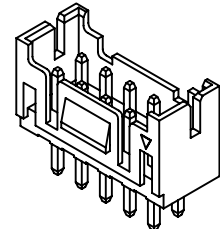
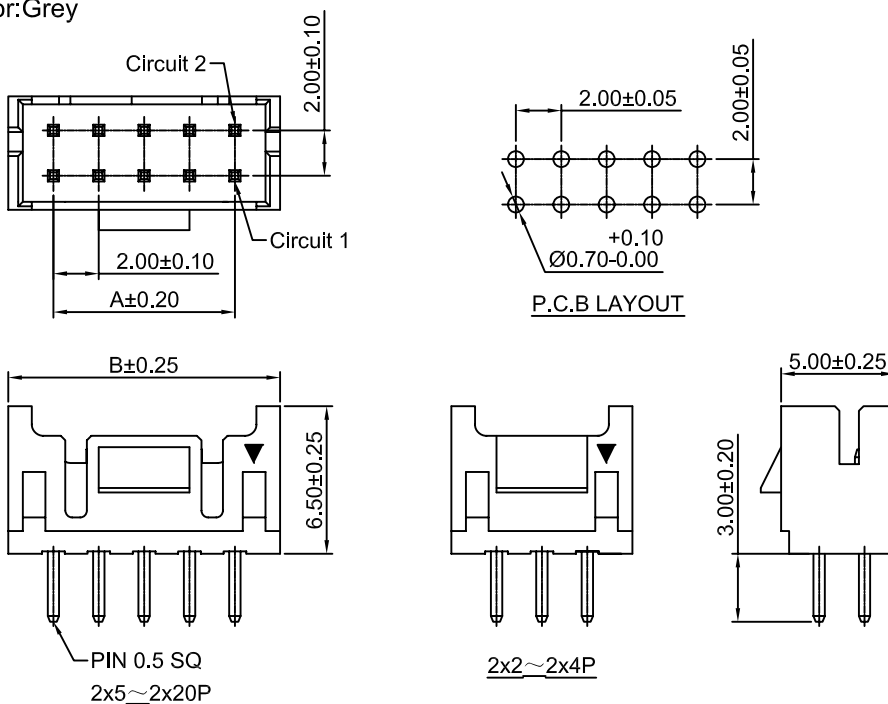

Ordering Information & Dimensions:

PART NO.	Dimensions	
	A	B
2x2P	2.00	6.00
2x3P	4.00	8.00
2x4P	6.00	10.00
2x5P	8.00	12.00
2x6P	10.00	14.00
2x7P	12.00	16.00
2x8P	14.00	18.00
2x9P	16.00	20.00
2x10P	18.00	22.00
2x11P	20.00	24.00
2x12P	22.00	26.00
2x13P	24.00	28.00
2x14P	26.00	30.00
2x15P	28.00	32.00
2x16P	30.00	34.00
2x17P	32.00	36.00
2x18P	34.00	38.00
2x19P	36.00	40.00
2x20P	38.00	42.00

Unit: mm

CJTconn A2006 SERIES

2.00mm pitch wire to board connector

A2006WRB-2xXP

2.00mm pitch 90° Dual Row Wafer

Reference Informations:

- *Material:Pin:Brass/Tin over Nickel
Insulator:Nylon 66,UL94V-0
- *Mates with CJT A2006HB series Dual Row Housing
- *Color:White

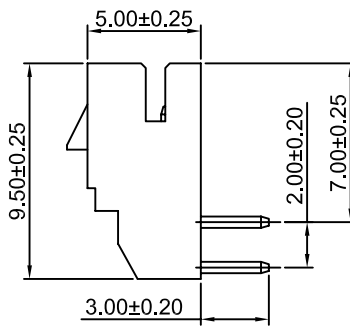
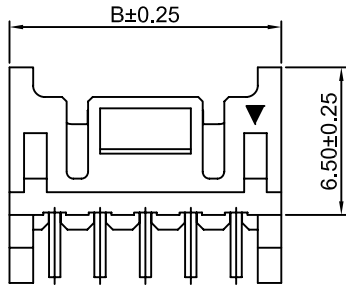
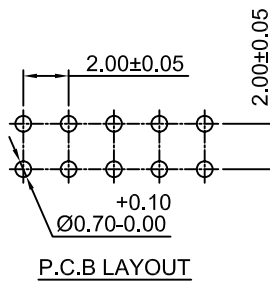
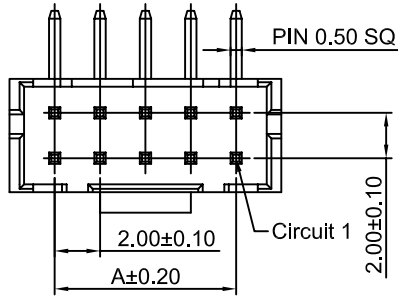
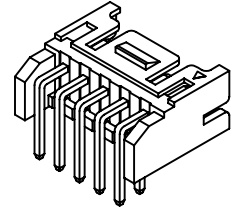

Ordering Information & Dimensions:

PART NO.	Dimensions	
	A	B
2x2P	2.00	6.00
2x3P	4.00	8.00
2x4P	6.00	10.00
2x5P	8.00	12.00
2x6P	10.00	14.00
2x7P	12.00	16.00
2x8P	14.00	18.00
2x9P	16.00	20.00
2x10P	18.00	22.00
2x11P	20.00	24.00
2x12P	22.00	26.00
2x13P	24.00	28.00
2x14P	26.00	30.00
2x15P	28.00	32.00
2x16P	30.00	34.00
2x17P	32.00	36.00
2x18P	34.00	38.00
2x19P	36.00	40.00
2x20P	38.00	42.00

Unit: mm

A2006WVU-2xXP

2.00mm pitch 180° Dual Row Wafer

Reference Informations:

- *Material:Pin:Brass/Tin over Nickel
Insulator:PA4T,UL94V-0
- *Mates with CJT A2006HU series Dual Row Housing
- *Color:Natural

Ordering Information:

A2006WVU-2xXP - ^{*}/_{1 2}

- 1.Part No.
- 2.Finish
(blank) :Tin over Nickel
G :Gold over Nickel

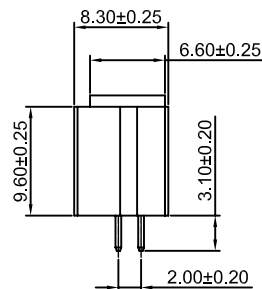
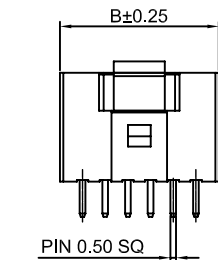
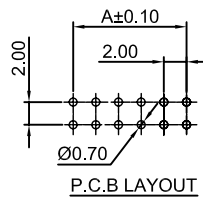
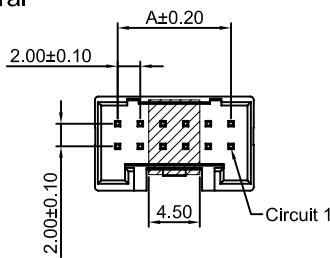
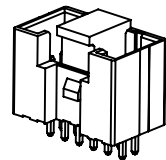

Ordering Information & Dimensions:

PART NO.	Dimensions	
	A	B
2x4P	6.00	10.00
2x5P	8.00	12.00
2x6P	10.00	14.00
2x7P	12.00	16.00
2x8P	14.00	18.00
2x9P	16.00	20.00
2x10P	18.00	22.00
2x11P	20.00	24.00
2x12P	22.00	26.00
2x13P	24.00	28.00
2x14P	26.00	30.00
2x15P	28.00	32.00
2x16P	30.00	34.00
2x17P	32.00	36.00
2x18P	34.00	38.00
2x19P	36.00	40.00
2x20P	38.00	42.00

Unit: mm

2x4P~2x7P Without Guideway
2x8P~2x20P Without Guideway

2x4P~2x5P

2x6P~2x9P

2x10P~2x20P

CJTconn A2006 SERIES

2.00mm pitch wire to board connector

A2006WRU-2xXP

2.00mm pitch 90° Dual Row Wafer

Reference Informations:

- *Material:Pin:Brass/Tin over Nickel
Insulator:PA4T,UL94V-0
- *Mates with CJT A2006HU series Dual Row Housing
- *Color:Natural

- Ordering Information:
A2006WRU-2xXP - ^{**}/₂ - ^{*}/₃
- 1.Part No.
 - 2.Size(L):
(blank) :3.00mm
L18 :1.80mm
 - 3.Finish
(blank) :Tin over Nickel
G :Gold over Nickel

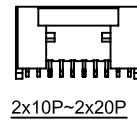
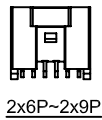
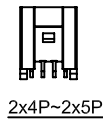
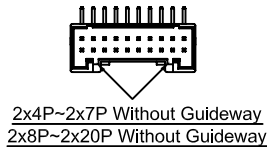
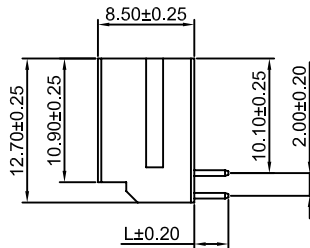
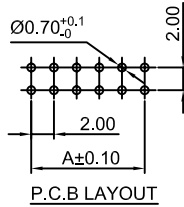
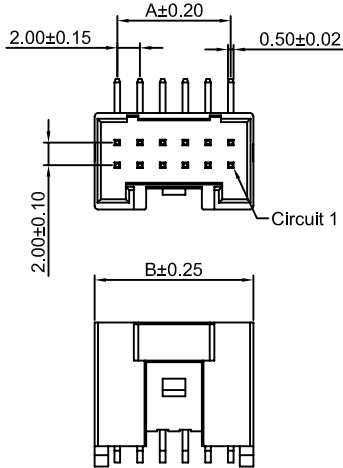
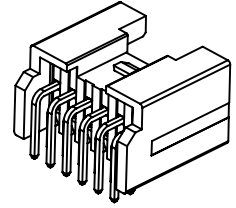

Ordering Information & Dimensions:

PART NO.	Dimensions	
	A	B
2x4P	6.00	10.00
2x5P	8.00	12.00
2x6P	10.00	14.00
2x7P	12.00	16.00
2x8P	14.00	18.00
2x9P	16.00	20.00
2x10P	18.00	22.00
2x11P	20.00	24.00
2x12P	22.00	26.00
2x13P	24.00	28.00
2x14P	26.00	30.00
2x15P	28.00	32.00
2x16P	30.00	34.00
2x17P	32.00	36.00
2x18P	34.00	38.00
2x19P	36.00	40.00
2x20P	38.00	42.00

Unit: mm

A2006WVU-F-2xXP

2.00mm pitch 180° Dual Row Wafer

Reference Informations:

- *Material:Pin:Brass/Tin over Nickel
Insulator:PA4T,UL94V-0
- *Mates with CJT A2006HU series Dual Row Housing
- *Color:Natural

- Ordering Information:
A2006WVU-F-2xXP - ^{*}/₂
- 1.Part No.
 - 2.Finish
(blank) :Tin over Nickel
G :Gold over Nickel

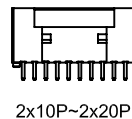
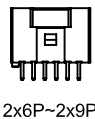
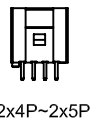
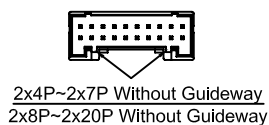
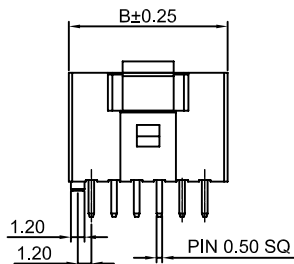
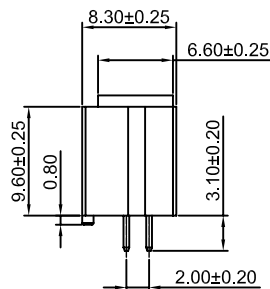
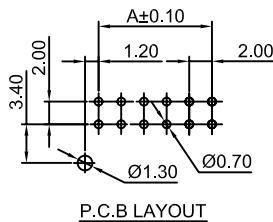
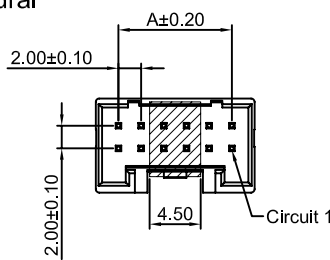
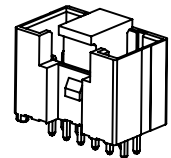

Ordering Information & Dimensions:

PART NO.	Dimensions	
	A	B
2x4P	6.00	10.00
2x5P	8.00	12.00
2x6P	10.00	14.00
2x7P	12.00	16.00
2x8P	14.00	18.00
2x9P	16.00	20.00
2x10P	18.00	22.00
2x11P	20.00	24.00
2x12P	22.00	26.00
2x13P	24.00	28.00
2x14P	26.00	30.00
2x15P	28.00	32.00
2x16P	30.00	34.00
2x17P	32.00	36.00
2x18P	34.00	38.00
2x19P	36.00	40.00
2x20P	38.00	42.00

Unit: mm

CJTconn A2006 SERIES

2.00mm pitch wire to board connector

A2006WRU-F-2xXP

2.00mm pitch 90° Dual Row Wafer

Reference Informations:

- *Material:Pin:Brass/Tin over Nickel
Insulator:PA4T,UL94V-0
- *Mates with CJT A2006HU series Dual Row Housing
- *Color:Natural

- Ordering Information:
A2006WRU-F-2xXP - ^{**}/₂ - ^{*}/₃
- 1.Part No.
 - 2.Size(L):
 (blank) :3.00mm
 L18 :1.80mm
 - 3.Finish
 (blank) :Tin over Nickel
 G :Gold over Nickel

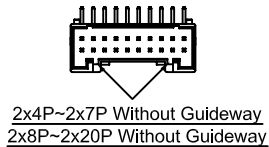
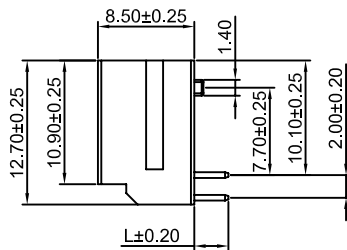
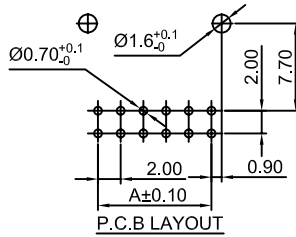
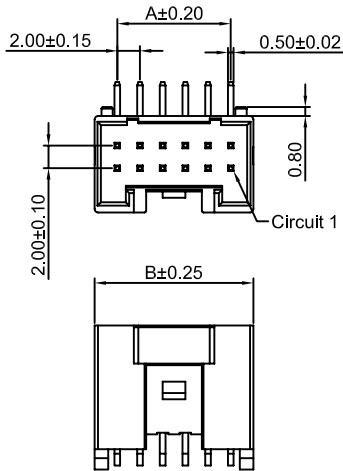
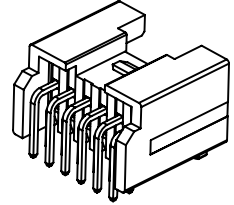

2x4P~2x5P



2x6P~2x9P

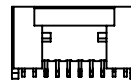

2x10P~2x20P

Ordering Information & Dimensions:

PART NO.	Dimensions	
	A	B
2x4P	6.00	10.00
2x5P	8.00	12.00
2x6P	10.00	14.00
2x7P	12.00	16.00
2x8P	14.00	18.00
2x9P	16.00	20.00
2x10P	18.00	22.00
2x11P	20.00	24.00
2x12P	22.00	26.00
2x13P	24.00	28.00
2x14P	26.00	30.00
2x15P	28.00	32.00
2x16P	30.00	34.00
2x17P	32.00	36.00
2x18P	34.00	38.00
2x19P	36.00	40.00
2x20P	38.00	42.00

Unit: mm