

## Specifications

- Current rating:2A AC,DC
- Voltage rating:100V AC,DC
- Temperature range:-40°C~+105°C
- Contact resistance:10mΩMax.
- Insulation resistance:1000MΩMin.
- Withstanding voltage:800V AC/minute
- \*Compliant with RoHS and REACH\*
- \*Meet the HF/Halogen Free,need to customize\*
- \*Contact CJT for details\*

## Standards



## Assembly layout

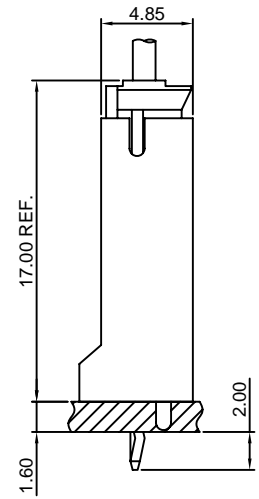
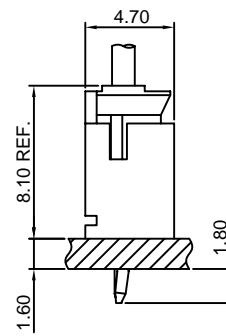
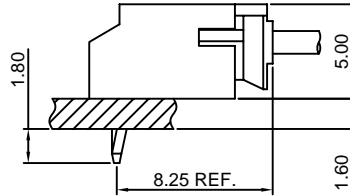
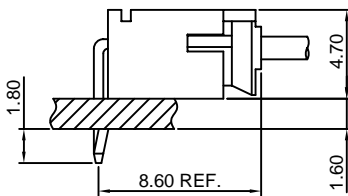

DIP TYPE

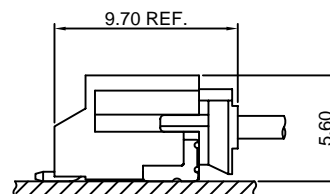
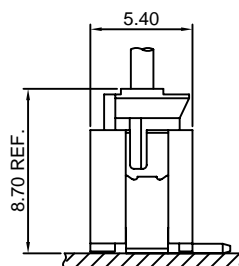

SMT TYPE

**A2001-T**

2.00mm pitch Crimp Terminal

**Reference Informations:**

\*Used in CJT [A2001H] series Housing

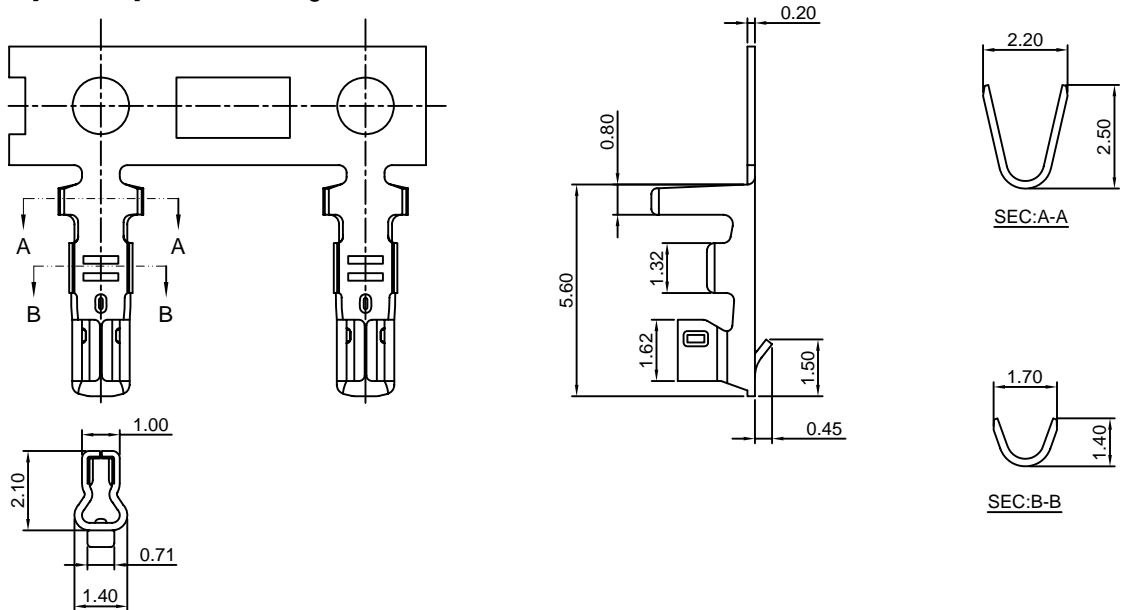

Ordering information & Specifications:

Unit:mm

Part NO	Wire Range	Insulation O.D.	Material	Finish	Qty/reel
A2001-TP	AWG#24-#30	1.50mm(max)	Phosphor Bronze	Tin over Nickel	10,000 PCS
A2001-GP	AWG#24-#30	1.50mm(max)	Phosphor Bronze	Gold over Nickel	10,000 PCS

Optional Gold plating available but MOQ requested

**A2001M-T**

2.00mm pitch Crimp Terminal

**Reference Informations:**

\*Used in CJT [A2001HM] series Housing

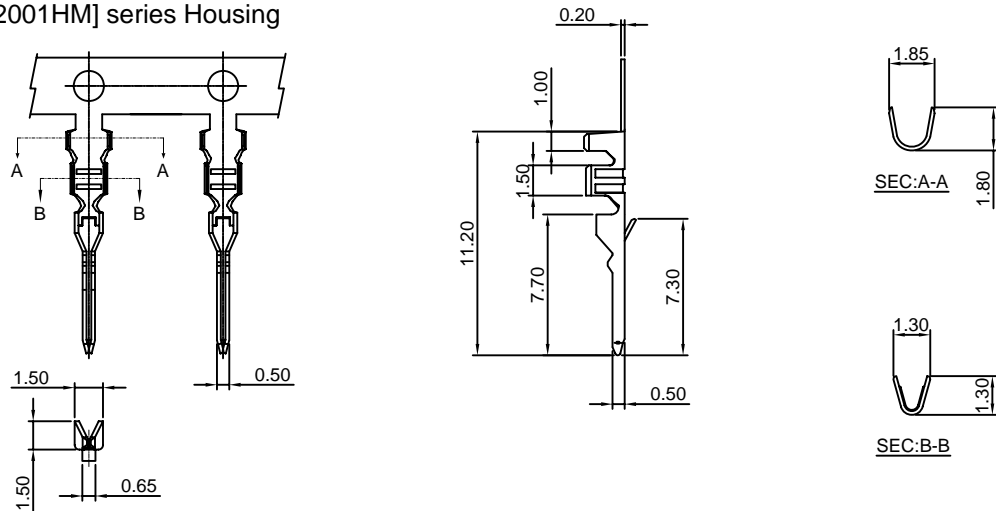

Ordering information & Specifications:

Unit:mm

Part NO	Wire Range	Insulation O.D.	Material	Finish	Qty/reel
A2001M-TP	AWG#24-#30	1.50mm(max)	Phosphor Bronze	Tin over Nickel	10,000 PCS
A2001M-TB	AWG#24-#30	1.50mm(max)	Brass	Tin over Nickel	10,000 PCS
A2001M-GP	AWG#24-#30	1.50mm(max)	Phosphor Bronze	Gold over Nickel	10,000 PCS
A2001M-GB	AWG#24-#30	1.50mm(max)	Brass	Gold over Nickel	10,000 PCS

Optional Gold plating available but MOQ requested



# A2001 SERIES

2.00mm pitch wire to board connector

## A2001H

2.00mm pitch Housing

### Reference Informations:

- \*Material:Nylon 66,UL94V-0
- \*Suitable CJT [A2001-T] series Terminal
- \*Mates with CJT [A2001WV,A2001WR,A2001WV-S,A2001WR-S,A2001WVR,A2001WV-F-H] series Wafer
- \*Color:White

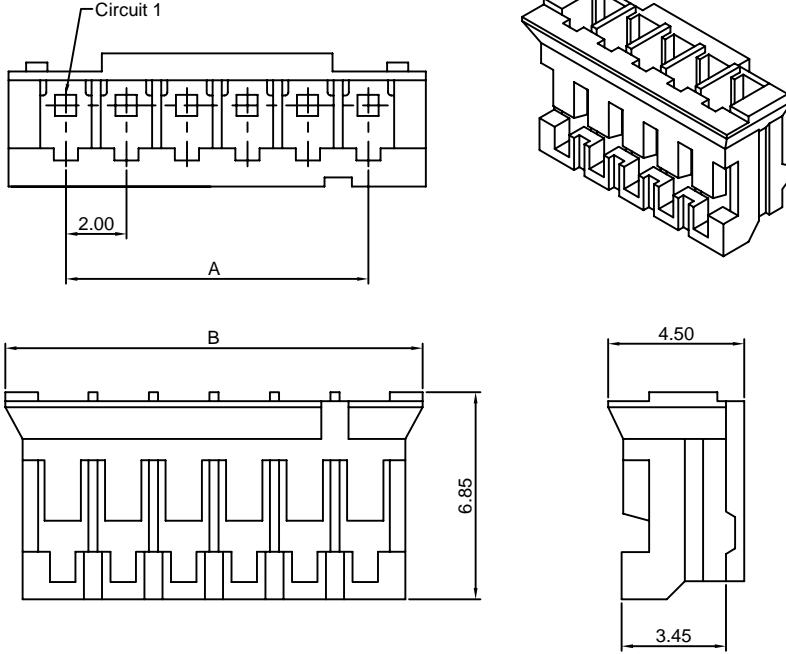

### Ordering Information & Dimensions:

PART NO.	Dimensions	
	A	B
A2001H-2P	2.00	5.80
A2001H-3P	4.00	7.80
A2001H-4P	6.00	9.80
A2001H-5P	8.00	11.80
A2001H-6P	10.00	13.80
A2001H-7P	12.00	15.80
A2001H-8P	14.00	17.80
A2001H-9P	16.00	19.80
A2001H-10P	18.00	21.80
A2001H-11P	20.00	23.80
A2001H-12P	22.00	25.80
A2001H-13P	24.00	27.80
A2001H-14P	26.00	29.80
A2001H-15P	28.00	31.80
A2001H-16P	30.00	33.80
A2001H-17P	32.00	35.80
A2001H-18P	34.00	37.80
A2001H-19P	36.00	39.80
A2001H-20P	38.00	41.80

Unit: mm

## A2001HM

2.00mm pitch Housing

### Reference Informations:

- \*Material:Nylon 66,UL94V-0
- \*Suitable CJT [A2001M-T] series Terminal
- \*Color:White

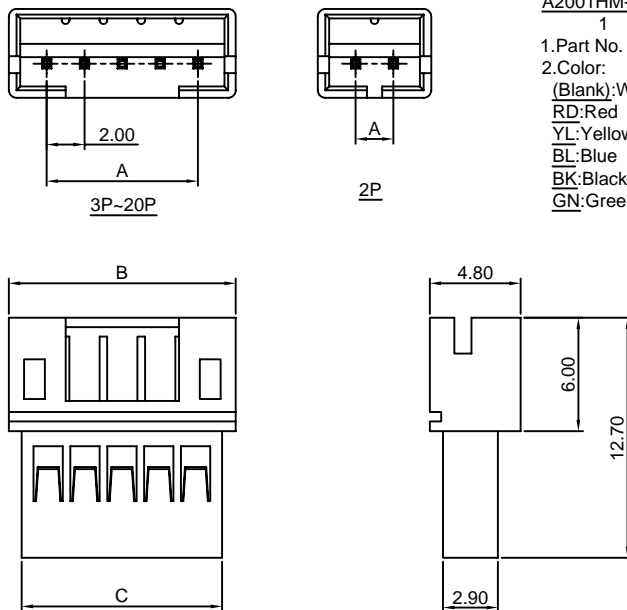

Ordering Information:  
A2001HM-XP - \*\*  
1 2

- 1.Part No.
- 2.Color:  
(Blank):White  
RD:Red  
YL:Yellow  
BL:Blue  
BK:Black  
GN:Green

### Ordering Information & Dimensions:

PART NO.	Dimensions		
	A	B	C
A2001HM-2P	2.00	6.00	4.60
A2001HM-3P	4.00	8.00	6.60
A2001HM-4P	6.00	10.00	8.60
A2001HM-5P	8.00	12.00	10.60
A2001HM-6P	10.00	14.00	12.60
A2001HM-7P	12.00	16.00	14.60
A2001HM-8P	14.00	18.00	16.60
A2001HM-9P	16.00	20.00	18.60
A2001HM-10P	18.00	22.00	20.60
A2001HM-11P	20.00	24.00	22.60
A2001HM-12P	22.00	26.00	24.60
A2001HM-13P	24.00	28.00	26.60
A2001HM-14P	26.00	30.00	28.60
A2001HM-15P	28.00	32.00	30.60
A2001HM-16P	30.00	34.00	32.60
A2001HM-17P	32.00	36.00	34.60
A2001HM-18P	34.00	38.00	36.60
A2001HM-19P	36.00	40.00	38.60
A2001HM-20P	38.00	42.00	40.60

Unit: mm

### A2001WV

2.00mm pitch 180° Wafer

#### Reference Informations:

- \*Material:Pin:Brass/Tin over Nickel  
Insulator:Nylon 66,UL94V-0
- \*Mates with CJT [A2001H] series Housing
- \*Color:White

Ordering Information:  
A2001WV-XP - \*\*  
 1  
 2

1.Part No.  
 2.Style:  
 (blank) :Type 1  
 2 :Type 2  
 3 :Type 3

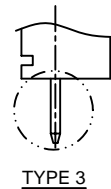
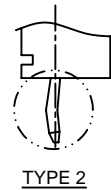
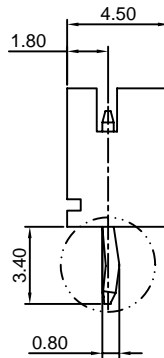
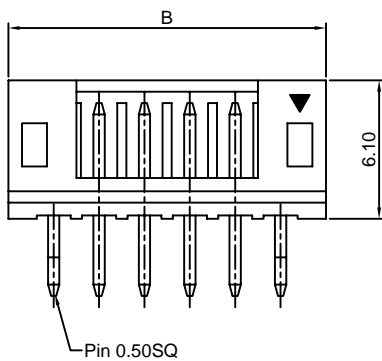
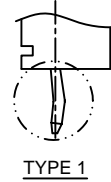
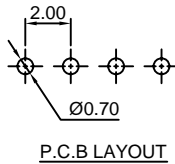
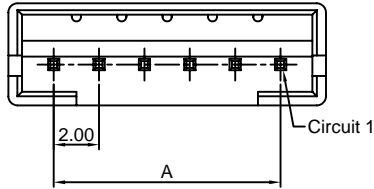
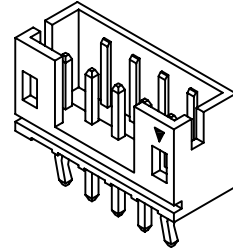

Ordering Information & Dimensions:

PART NO.	Dimensions	
	A	B
A2001WV-2P	2.00	6.00
A2001WV-3P	4.00	8.00
A2001WV-4P	6.00	10.00
A2001WV-5P	8.00	12.00
A2001WV-6P	10.00	14.00
A2001WV-7P	12.00	16.00
A2001WV-8P	14.00	18.00
A2001WV-9P	16.00	20.00
A2001WV-10P	18.00	22.00
A2001WV-11P	20.00	24.00
A2001WV-12P	22.00	26.00
A2001WV-13P	24.00	28.00
A2001WV-14P	26.00	30.00
A2001WV-15P	28.00	32.00
A2001WV-16P	30.00	34.00
A2001WV-17P	32.00	36.00
A2001WV-18P	34.00	38.00
A2001WV-19P	36.00	40.00
A2001WV-20P	38.00	42.00

Unit: mm

### A2001WR

2.00mm pitch 90° Wafer

#### Reference Informations:

- \*Material:Pin:Brass/Tin over Nickel  
Insulator:Nylon 66,UL94V-0
- \*Mates with CJT [A2001H] series Housing
- \*Color:White

Ordering Information:  
A2001WR-XP - \*\*  
 1  
 2

1.Part No.  
 2.Style:  
 (blank) :Type 1  
 2 :Type 2

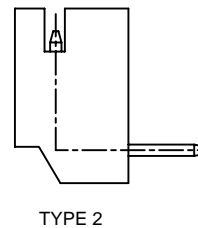
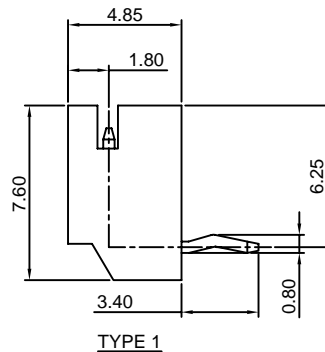
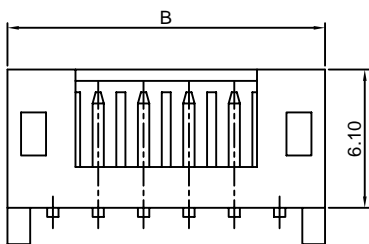
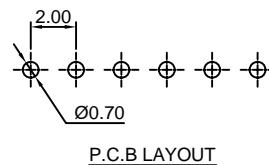
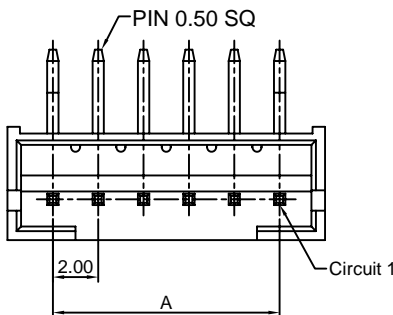
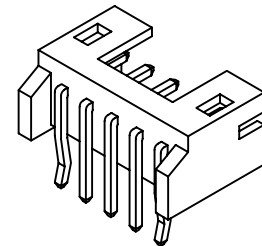

Ordering Information & Dimensions:

PART NO.	Dimensions	
	A	B
A2001WR-2P	2.00	6.00
A2001WR-3P	4.00	8.00
A2001WR-4P	6.00	10.00
A2001WR-5P	8.00	12.00
A2001WR-6P	10.00	14.00
A2001WR-7P	12.00	16.00
A2001WR-8P	14.00	18.00
A2001WR-9P	16.00	20.00
A2001WR-10P	18.00	22.00
A2001WR-11P	20.00	24.00
A2001WR-12P	22.00	26.00
A2001WR-13P	24.00	28.00
A2001WR-14P	26.00	30.00
A2001WR-15P	28.00	32.00
A2001WR-16P	30.00	34.00
A2001WR-17P	32.00	36.00
A2001WR-18P	34.00	38.00
A2001WR-19P	36.00	40.00
A2001WR-20P	38.00	42.00

Unit: mm

### A2001WV-S

2.00mm pitch 180° Wafer-SMT TYPE

**Reference Informations:**

- \*Material:Pin:Brass/Tin over Nickel  
Insulator:Nylon 6T,UL94V-0
- \*Mates with CJT [A2001H] series Housing
- \*Color:Ivory

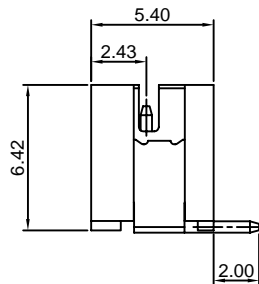
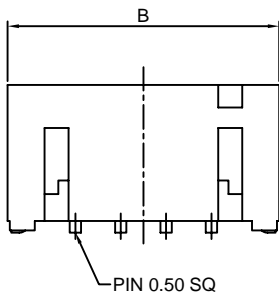
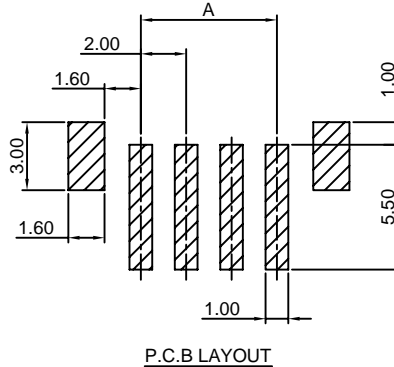
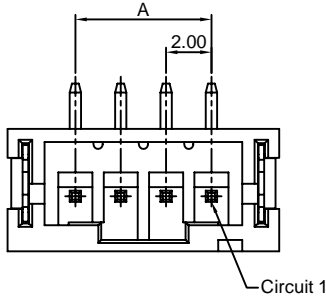
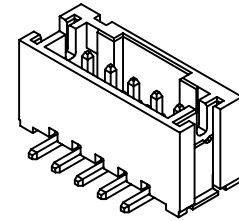

Ordering Information & Dimensions:

PART NO.	Dimensions	
	A	B
A2001WV-S-2P	2.00	8.00
A2001WV-S-3P	4.00	10.00
A2001WV-S-4P	6.00	12.00
A2001WV-S-5P	8.00	14.00
A2001WV-S-6P	10.00	16.00
A2001WV-S-7P	12.00	18.00
A2001WV-S-8P	14.00	20.00
A2001WV-S-9P	16.00	22.00
A2001WV-S-10P	18.00	24.00
A2001WV-S-11P	20.00	26.00
A2001WV-S-12P	22.00	28.00
A2001WV-S-13P	24.00	30.00
A2001WV-S-14P	26.00	32.00
A2001WV-S-15P	28.00	34.00
A2001WV-S-16P	30.00	36.00
A2001WV-S-17P	32.00	38.00
A2001WV-S-18P	34.00	40.00
A2001WV-S-19P	36.00	42.00
A2001WV-S-20P	38.00	44.00

Unit: mm

### A2001WR-S

2.00mm pitch 90° Wafer-SMT TYPE

**Reference Informations:**

- \*Material:Pin:Brass/Tin over Nickel  
Insulator:Nylon 6T,UL94V-0
- \*Mates with CJT [A2001H] series Housing
- \*Color:Ivory

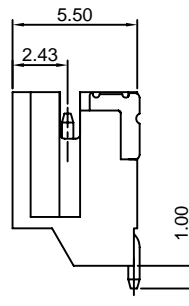
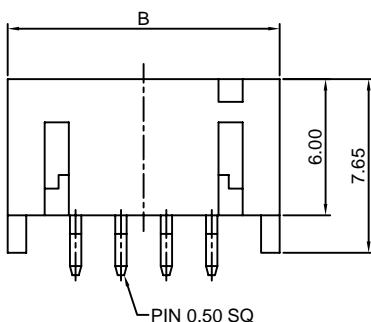
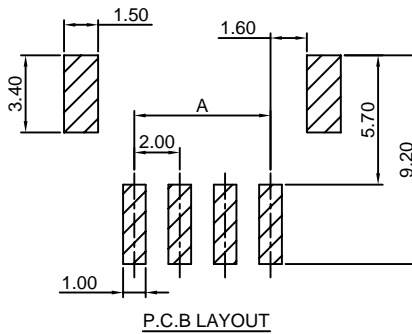
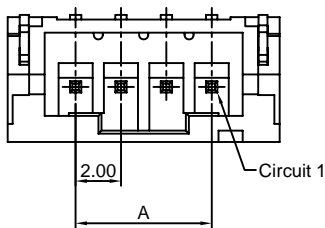
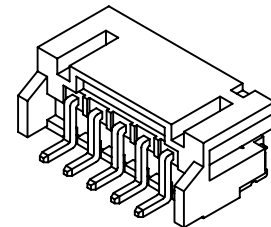

Ordering Information & Dimensions:

PART NO.	Dimensions	
	A	B
A2001WR-S-2P	2.00	8.00
A2001WR-S-3P	4.00	10.00
A2001WR-S-4P	6.00	12.00
A2001WR-S-5P	8.00	14.00
A2001WR-S-6P	10.00	16.00
A2001WR-S-7P	12.00	18.00
A2001WR-S-8P	14.00	20.00
A2001WR-S-9P	16.00	22.00
A2001WR-S-10P	18.00	24.00
A2001WR-S-11P	20.00	26.00
A2001WR-S-12P	22.00	28.00
A2001WR-S-13P	24.00	30.00
A2001WR-S-14P	26.00	32.00
A2001WR-S-15P	28.00	34.00
A2001WR-S-16P	30.00	36.00
A2001WR-S-17P	32.00	38.00
A2001WR-S-18P	34.00	40.00
A2001WR-S-19P	36.00	42.00
A2001WR-S-20P	38.00	44.00

Unit: mm

# CJTconn A2001 SERIES

2.00mm pitch wire to board connector

## A2001WVR

2.00mm pitch 90° Wafer

### Reference Informations:

- \*Material:Pin:Brass/Tin over Nickel  
Insulator:Nylon 66,UL94V-0
- \*Mates with CJT [A2001H] series Housing
- \*Color:White

### Ordering Information:

- A2001WVR-XP - \*\*
- 1                          2
- 1.Part No.
  - 2.Style:  
(blank) :Type 1  
2 :Type 2

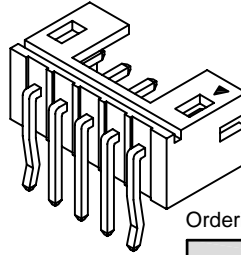

### Ordering Information & Dimensions:

PART NO.	Dimensions	
	A	B
A2001WVR-2P	2.00	6.00
A2001WVR-3P	4.00	8.00
A2001WVR-4P	6.00	10.00
A2001WVR-5P	8.00	12.00
A2001WVR-6P	10.00	14.00
A2001WVR-7P	12.00	16.00
A2001WVR-8P	14.00	18.00
A2001WVR-9P	16.00	20.00
A2001WVR-10P	18.00	22.00
A2001WVR-11P	20.00	24.00
A2001WVR-12P	22.00	26.00
A2001WVR-13P	24.00	28.00
A2001WVR-14P	26.00	30.00
A2001WVR-15P	28.00	32.00
A2001WVR-16P	30.00	34.00
A2001WVR-17P	32.00	36.00
A2001WVR-18P	34.00	38.00
A2001WVR-19P	36.00	40.00
A2001WVR-20P	38.00	42.00

Unit: mm

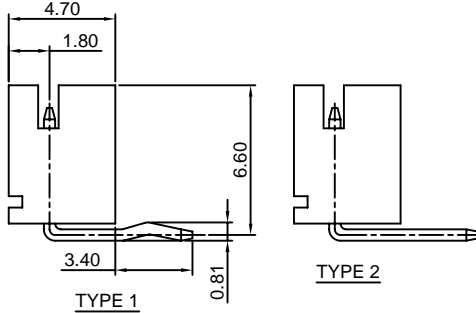
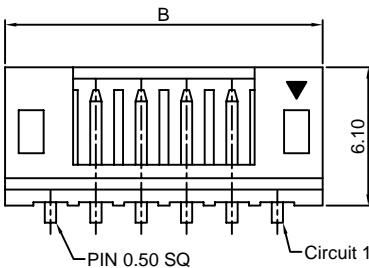
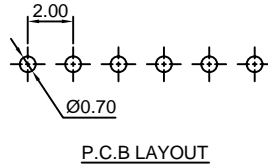
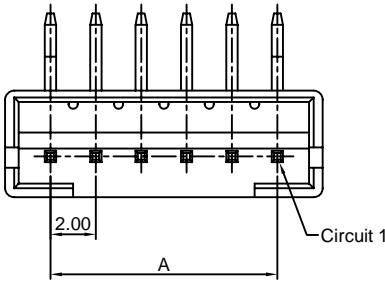

## A2001WV-F-H

2.00mm pitch 180° Wafer-High box type

### Reference Informations:

- \*Material:Pin:Brass/Tin over Nickel  
Insulator:Nylon 6T,UL94V-0
- \*Mates with CJT [A2001H] series Housing
- \*Color:White

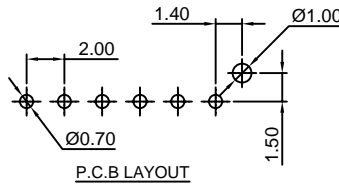

### Ordering Information & Dimensions:

PART NO.	Dimensions	
	A	B
A2001WV-F-2P-H	2.00	6.00
A2001WV-F-3P-H	4.00	8.00
A2001WV-F-4P-H	6.00	10.00
A2001WV-F-5P-H	8.00	12.00
A2001WV-F-6P-H	10.00	14.00
A2001WV-F-7P-H	12.00	16.00
A2001WV-F-8P-H	14.00	18.00
A2001WV-F-9P-H	16.00	20.00
A2001WV-F-10P-H	18.00	22.00
A2001WV-F-11P-H	20.00	24.00
A2001WV-F-12P-H	22.00	26.00
A2001WV-F-13P-H	24.00	28.00
A2001WV-F-14P-H	26.00	30.00
A2001WV-F-15P-H	28.00	32.00
A2001WV-F-16P-H	30.00	34.00
A2001WV-F-17P-H	32.00	36.00
A2001WV-F-18P-H	34.00	38.00
A2001WV-F-19P-H	36.00	40.00
A2001WV-F-20P-H	38.00	42.00

Unit: mm

