



RS321S, RS358S RS321, RS358, RS324

1.1MHz, Rail-to-Rail I/O CMOS Operational Amplifier

FEATURES

- HIGH GAIN BANDWIDTH:1.1MHz
- RAIL-TO-RAIL INPUT AND OUTPUT
0.8mV Typical Vos
- INPUT VOLTAGE RANGE: -0.1V to +5.6V
with Vs = 5.5V
- SUPPLY RANGE: +2.5V to +5.5V
- SHUTDOWN: RS321S/RS358S
- SPECIFIED UP TO +125°C
- MicroSIZE PACKAGES: SOT23-5, SOT23-6

APPLICATIONS

- SENSORS
- PHOTODIODE AMPLIFICATION
- ACTIVE FILTERS
- TEST EQUIPMENT
- DRIVING A/D CONVERTERS

DESCRIPTION

The RS321, RS358, RS324, RS321S, RS358S families of products offer low voltage operation and rail-to-rail input and output, as well as excellent speed/power consumption ratio, providing an excellent bandwidth (1.1MHz) and slew rate of 0.5V/us. The op-amps are unity gain stable and feature an ultra-low input bias current.

The devices are ideal for sensor interfaces, active filters and portable applications. The RS321S, RS358S include a shutdown mode. Under logic control, the amplifiers can be switched from normal operation to a standby current that is less than 1uA. The RS321, RS358, RS324, RS321S, RS358S families of operational amplifiers are specified at the full temperature range of -40°C to +125°C under single or dual power supplies of 2.5V to 5.5V.

PIN CONFIGURATIONS

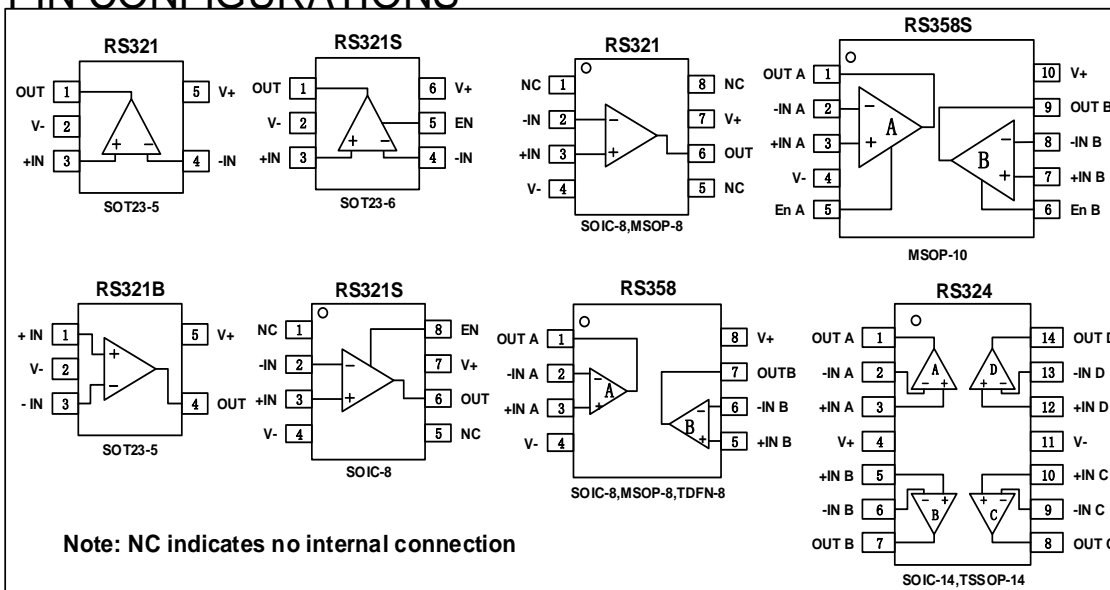

ABSOLUTE MAXIMUM RATINGS ⁽¹⁾

Supply Voltage, V+ to V-.....	7.0V
Input Terminals, Voltage ⁽²⁾	- 0.5 to (V+) + 0.5V
Current ⁽²⁾	±10mA
Storage Temperature	-65°C to +150°C
Operating Temperature	-40°C to +125°C
Junction Temperature.....	150°C
Package Thermal Resistance @ T _A = +25°C	
SOT23-5, SOT23-6.....	200°C/W
MSOP-10, SOIC-8	150°C/W
SOIC-14, TSSOP-14.....	100°C/W
Lead Temperature (Soldering, 10s)	260°C
ESD Susceptibility	
HBM	5000V
MM	400V

(1) Stresses above these ratings may cause permanent damage. Exposure to absolute maximum conditions for extended periods may degrade device reliability. These are stress ratings only, and functional operation of the device at these or any other conditions beyond those specified is not implied.

(2) Input terminals are diode-clamped to the power-supply rails. Input signals that can swing more than 0.5V beyond the supply rails should be current-limited to 10mA or less.



ESD SENSITIVITY CAUTION

ESD damage can range from subtle performance degradation to complete device failure. Precision integrated circuits may be more susceptible to damage because very small parametric changes could cause the device not to meet its published specifications.

PACKAGE/ORDERING INFORMATION

PRODUCT	ORDERING NUMBER	TEMPERATURE RANGE	PACKAGE LEAD	PACKAGE MARKING	PACKAGE OPTION
RS321	RS321XK	-40°C~125°C	SOIC-8	RS321	Tape and Reel,2500
	RS321XF	-40°C~125°C	SOT23-5	321	Tape and Reel,3000
	RS321BXF	-40°C~125°C	SOT23-5	321B	Tape and Reel,3000
	RS321XM	-40°C~125°C	MSOP-8	RS321	Tape and Reel,3000
RS321S	RS321SXK	-40°C~125°C	SOIC-8	RS321S	Tape and Reel,2500
	RS321SXH	-40°C~125°C	SOT23-6	321S	Tape and Reel,3000
RS358	RS358XK	-40°C~125°C	SOIC-8	RS358	Tape and Reel,2500
	RS358XM	-40°C~125°C	MSOP-8	RS358	Tape and Reel,3000
	RS358XT	-40°C~125°C	TDFN-8	RS358	Tape and Reel,3000
RS358S	RS358SXN	-40°C~125°C	MSOP-10	RS358S	Tape and Reel,3000
RS324	RS324XP	-40°C~125°C	SOIC -14	RS324	Tape and Reel,2500
	RS324XQ	-40°C~125°C	TSSOP-14	RS324	Tape and Reel,3000



ELECTRICAL CHARACTERISTICS

(At $T_A = +25^\circ\text{C}$, $V_S = 5\text{V}$, $R_L = 10\text{k}\Omega$ connected to $V_S/2$, and $V_{OUT} = V_S/2$, unless otherwise noted.)

PARAMETER	CONDITIONS	T_J	RS321S,RS358S, RS321,RS358,RS324			UNIT
			MIN	TYP	MAX	
POWER SUPPLY						
V_S	Operating Voltage Range	25°C	2.5		5.5	V
I_Q	Quiescent Current/Amplifier	25°C		60	85	μA
PSRR	Power-Supply Rejection Ratio	$V_S = 2.5\text{V to } 5.5\text{V}$ $V_{cm} = (V_-) + 0.5\text{V}$	25°C	62	85	dB
			$-40^\circ\text{C to } 125^\circ\text{C}$	58		
INPUT						
V_{OS}	Input Offset Voltage	25°C		0.8	4.5	mV
$V_{OS\ TC}$	Input Offset Voltage Average Drift	$-40^\circ\text{C to } 125^\circ\text{C}$		2.9		$\mu\text{V}/^\circ\text{C}$
I_B	Input Bias Current	25°C		1	10	pA
I_{OS}	Input Offset Current	25°C		1	10	pA
V_{cm}	Common-Mode Voltage Range	$V_S = 5.5\text{V}$	25°C	-0.1	5.6	V
CMRR	Common-Mode Rejection Ratio	$V_S = 5.5\text{V}$, $V_{cm} = -0.1\text{V to } 4\text{V}$	25°C	65	80	dB
			$-40^\circ\text{C to } 125^\circ\text{C}$	62		
		$V_S = 5.5\text{V}$, $V_{cm} = -0.1\text{V to } 5.6\text{V}$	25°C	57	75	
			$-40^\circ\text{C to } 125^\circ\text{C}$	55		
OUTPUT						
AOL	Open-Loop Voltage Gain	$R_L = 2\text{k}\Omega$, $V_o = 0.15\text{V to } 4.85\text{V}$	25°C	75	95	dB
			$-40^\circ\text{C to } 125^\circ\text{C}$	72		
		$R_L = 10\text{k}\Omega$, $V_o = 0.05\text{V to } 4.95\text{V}$	25°C	85	100	
			$-40^\circ\text{C to } 125^\circ\text{C}$	82		
	Output Swing From Rail	$R_L = 2\text{k}\Omega$	25°C		26	mV
		$R_L = 10\text{k}\Omega$	25°C		8	
I_{out}	Output Short-Circuit Current	25°C		54		mA
FREQUENCY RESPONSE						
SR	Slew Rate	25°C		0.5		V/us
GBP	Gain-Bandwidth Product	25°C		1.1		MHz
Φ_m	Phase Margin	25°C		64		$^\circ$
t_s	Settling Time, 0.1%	25°C		1.3		μs
	Overload Recovery Time	$V_{IN} \cdot \text{Gain} \geq V_S$	25°C		2.3	μs
NOISE						
e_n	Input-Referred Voltage Noise	$f = 1\text{ kHz}$	25°C		23	$\text{nV}/\sqrt{\text{Hz}}$
		$f = 10\text{ kHz}$	25°C		20	$\text{nV}/\sqrt{\text{Hz}}$
ENABLE/SHUTDOWN(RS321S,RS358S)						
$I_{Q(OFF)}$	Supply Current in Shutdown	25°C		<1		μA
t_{OFF}		25°C		3		μs
t_{ON}		25°C		20		μs
V_L	Shut Down	25°C		V_-	$(V_-) + 0.8$	V
V_H	Amplifier Is Active	25°C		$(V_-) + 2$	V_+	V

TYPICAL CHARACTERISTICS

At $T_A = +25^\circ\text{C}$, $V_S = 5\text{V}$, $R_L = 10\text{k}\Omega$ connected to $V_S/2$, $V_{OUT} = V_S/2$, unless otherwise noted.

OPEN-LOOP GAIN AND PHASE vs FREQUENCY

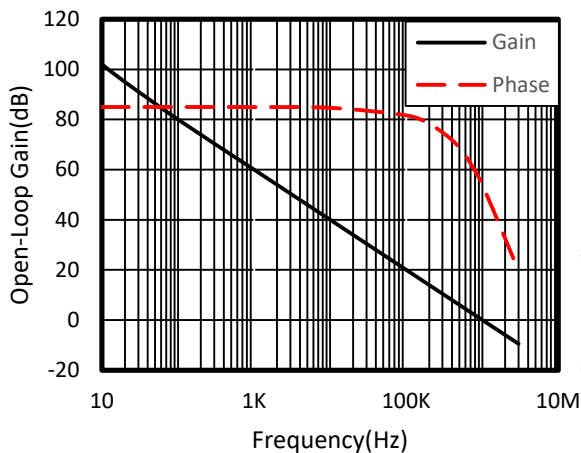

COMMON-MODE REJECTION RATIO vs FREQUENCY

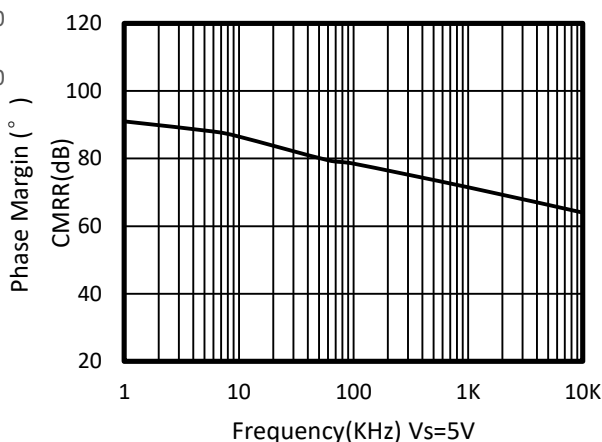

INPUT VOLTAGE NOISE SPECTRAL DENSITY vs FREQUENCY

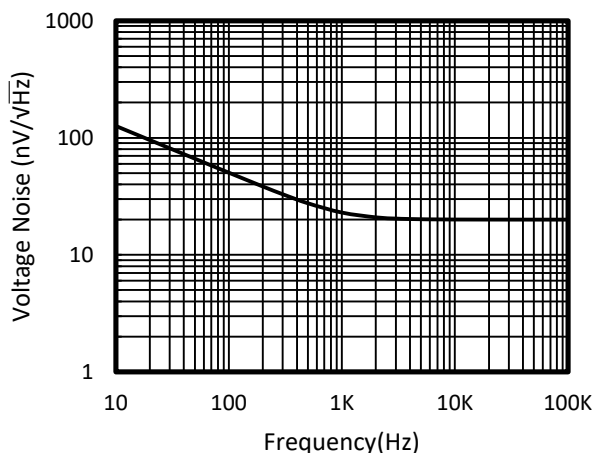

POWER-SUPPLY REJECTION RATIO vs FREQUENCY

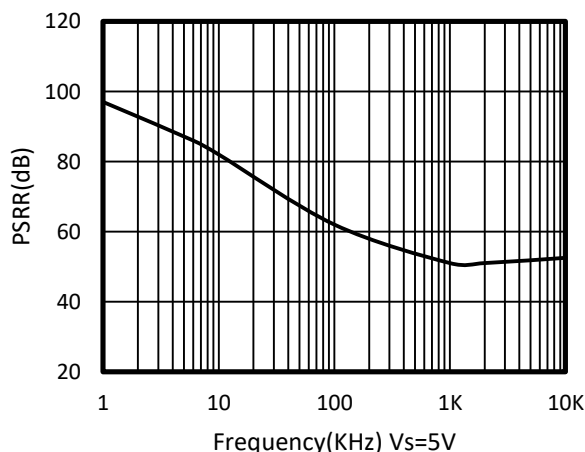

QUIESCENT CURRENT vs TEMPERATURE

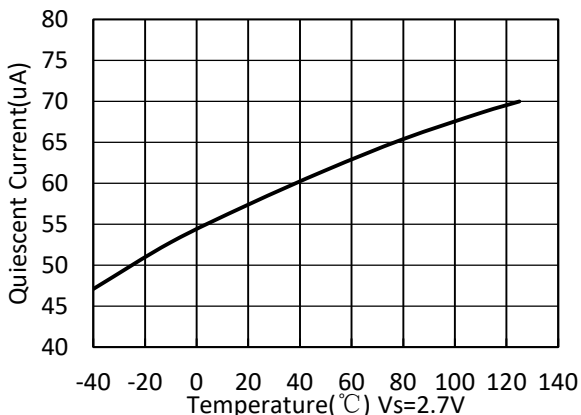

QUIESCENT CURRENT vs TEMPERATURE

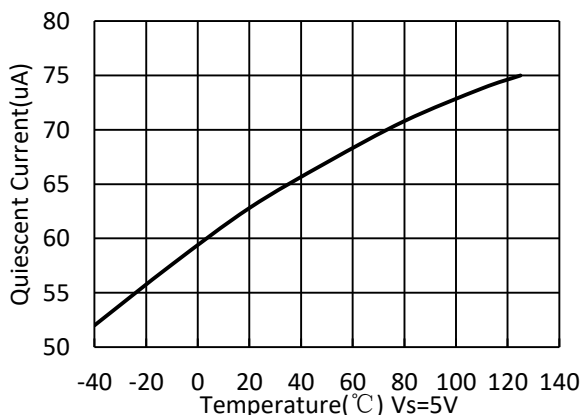

TYPICAL CHARACTERISTICS

At $T_A = +25^\circ\text{C}$, $V_S = 5\text{V}$, $R_L = 10\text{k}\Omega$ connected to $V_S/2$, $V_{OUT} = V_S/2$, unless otherwise noted.

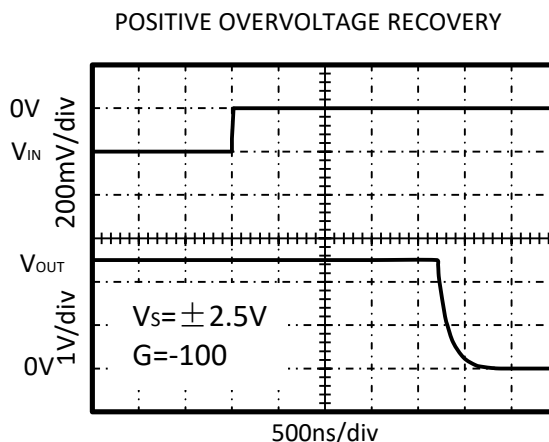
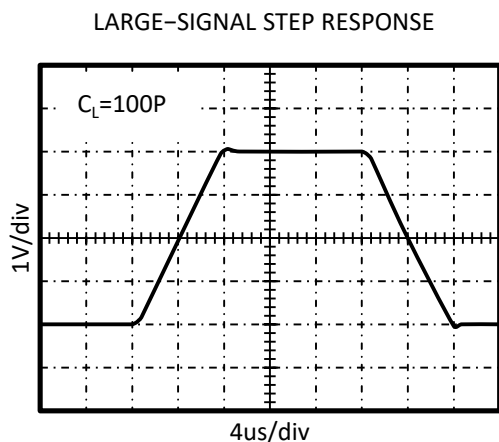
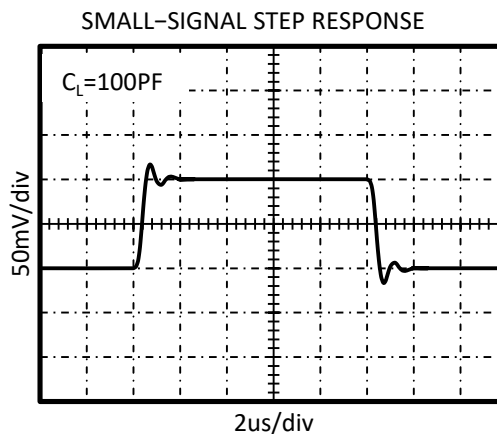
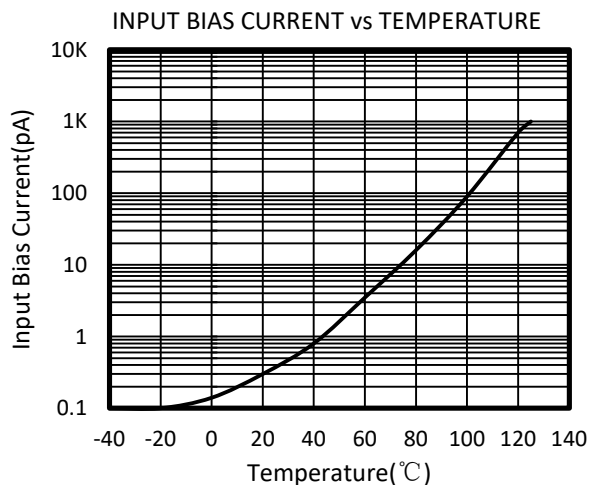
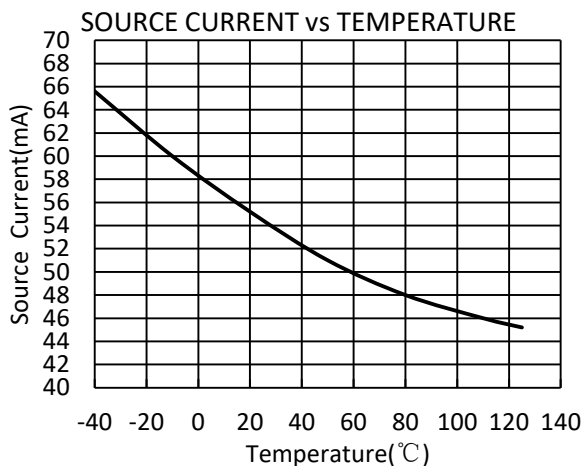
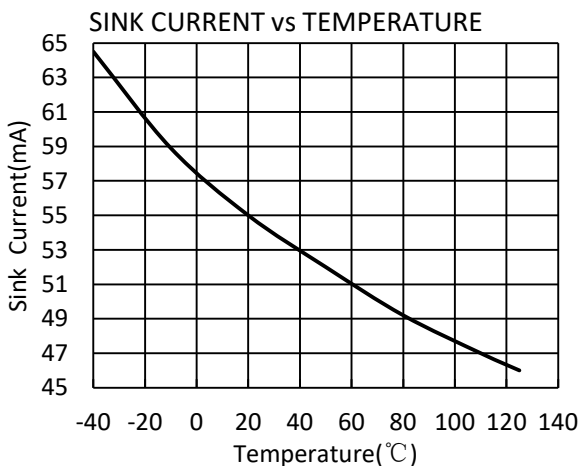

TYPICAL CHARACTERISTICS

At $T_A = +25^\circ\text{C}$, $V_S = 5\text{V}$, $R_L = 10\text{k}\Omega$ connected to $V_S/2$, $V_{OUT} = V_S/2$, unless otherwise noted.

Negative Overvoltage Recovery

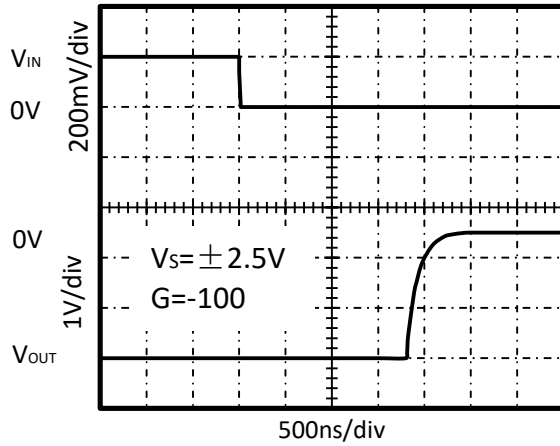

Offset Voltage Production Distribution

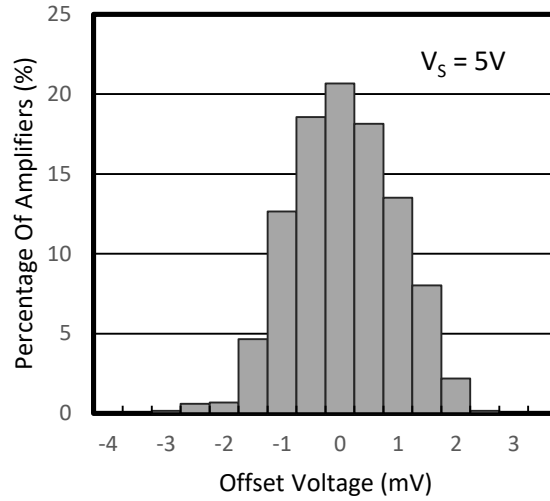

APPLICATION NOTES

The RS321, RS358, RS324, RS321S, RS358S are high precision, rail-to-rail operational amplifiers that can be run from a single-supply voltage 2.5V to 5.5V ($\pm 1.25V$ to $\pm 2.75V$). Supply voltages higher than 7V (absolute maximum) can permanently damage the amplifier.

Rail-to-rail input and output swing significantly increases dynamic range, especially in low-supply applications.

Good layout practice mandates use of a 0.1uF capacitor place closely across the supply pins.

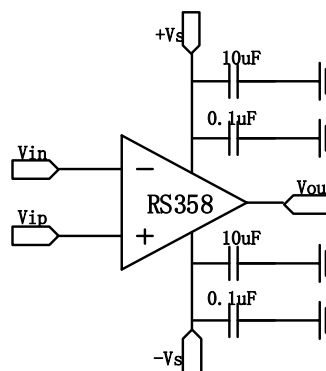

Figure1. Amplifier with Bypass Capacitors

RS321S/RS358S ENABLE FUNCTION

The RS321S/RS358S includes a shutdown mode. Under logic control, the amplifiers can be switched from normal mode to a standby current of 1uA. When the Enable pin is connected to high, the amplifier is active. Connecting Enable low disables the amplifier, and places the amplifier, and place the output in a high-impedance state.

LAYOUT GUIDELINS

Attention to good layout practices is always recommended. Keep traces short. When possible, use a PCB ground plane with surface-mount components placed as close to the device pins as possible. Place a 0.1uF capacitor closely across the supply pins.

These guidelines should be applied throughout the analog circuit to improve performance and provide benefits such as reducing the EMI susceptibility.

INSTRUMENTATION AMPLIFIER

In the three-op amp, instrumentation amplifier configuration shown in Figure2,

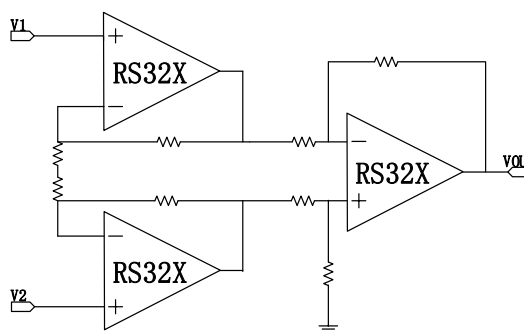
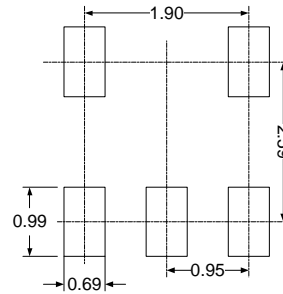
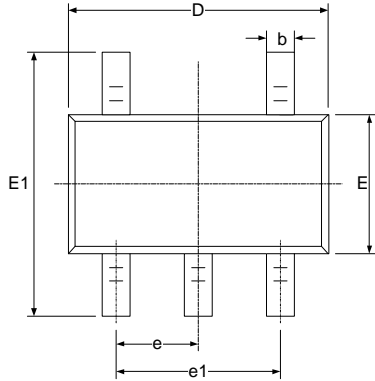

Figure2. Amplifier instrumentation amplifier

PACKAGE OUTLINE DIMENSIONS

SOT23-5



RECOMMENDED LAND PATTERN (Unit: mm)

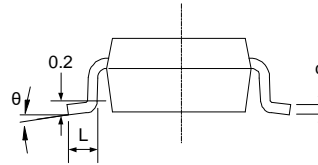
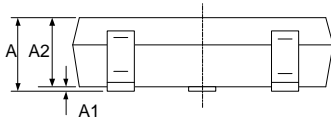

Symbol	Dimensions In Millimeters		Dimensions In Inches	
	Min	Max	Min	Max
A	1.050	1.250	0.041	0.049
A1	0.000	0.100	0.000	0.004
A2	1.050	1.150	0.041	0.045
b	0.300	0.500	0.012	0.020
c	0.100	0.200	0.004	0.008
D	2.820	3.020	0.111	0.119
E	1.500	1.700	0.059	0.067
E1	2.650	2.950	0.104	0.116
e	0.950(BSC)		0.037(BSC)	
e1	1.800	2.000	0.071	0.079
L	0.300	0.600	0.012	0.024
θ	0°	8°	0°	8°

SOT23-6

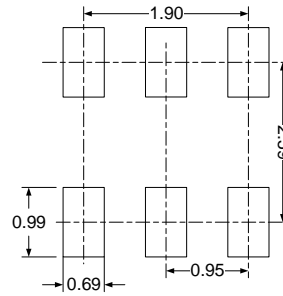
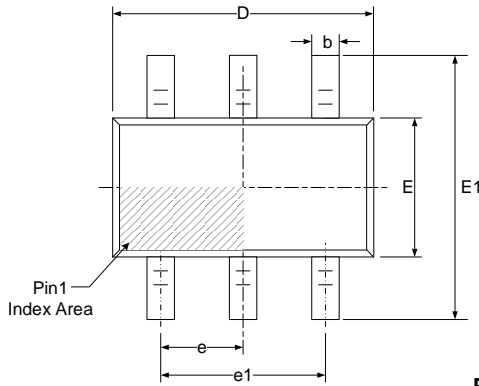

RECOMMENDED LAND PATTERN (Unit: mm)

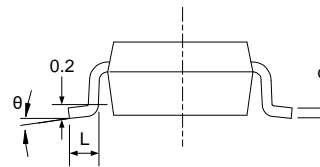
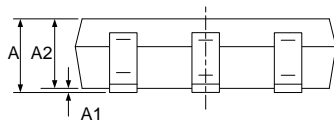

Symbol	Dimensions In Millimeters		Dimensions In Inches	
	Min	Max	Min	Max
A	1.050	1.250	0.041	0.049
A1	0.000	0.100	0.000	0.004
A2	1.050	1.150	0.041	0.045
b	0.300	0.500	0.012	0.020
c	0.100	0.200	0.004	0.008
D	2.820	3.020	0.111	0.119
E	1.500	1.700	0.059	0.067
E1	2.650	2.950	0.104	0.116
e	0.950(BSC)		0.037(BSC)	
e1	1.800	2.000	0.071	0.079
L	0.300	0.600	0.012	0.024
θ	0°	8°	0°	8°

MSOP-8

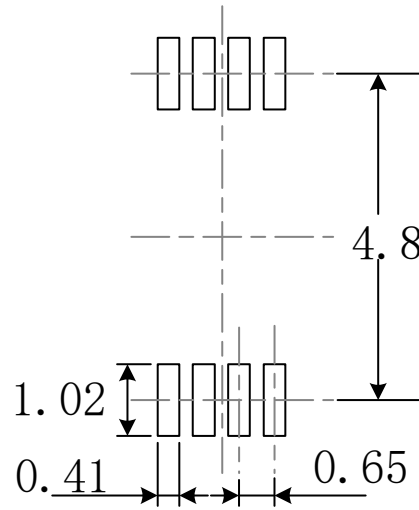
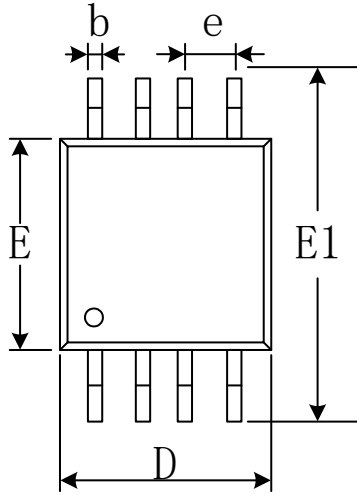

RECOMMENDED LAND PATTERN (Unit: mm)

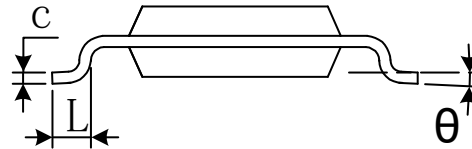
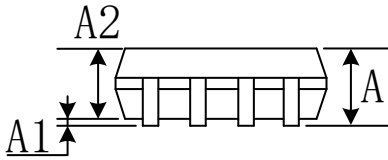

Symbol	Dimensions In Millimeters		Dimensions In Inches	
	Min	Max	Min	Max
A	0.820	1.100	0.032	0.043
A1	0.020	0.150	0.001	0.006
A2	0.750	0.950	0.030	0.037
b	0.250	0.380	0.010	0.015
c	0.090	0.230	0.004	0.009
D	2.900	3.100	0.114	0.122
e	0.650(BSC)		0.026(BSC)	
E	2.900	3.100	0.114	0.122
E1	4.750	5.050	0.187	0.199
L	0.400	0.800	0.016	0.031
θ	0°	6°	0°	6°

MSOP-10

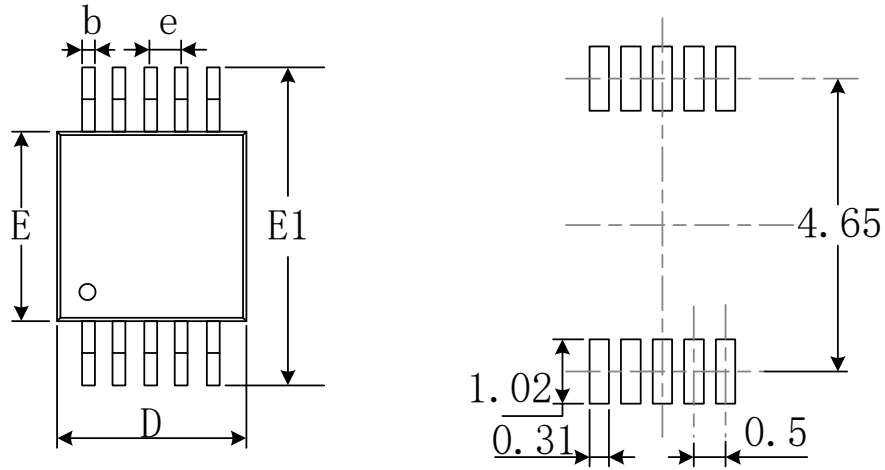

RECOMMENDED LAND PATTERN (Unit: mm)

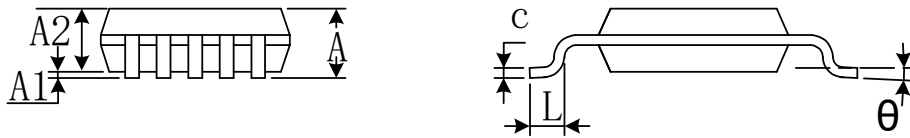

Symbol	Dimensions In Millimeters		Dimensions In Inches	
	Min	Max	Min	Max
A	0.820	1.100	0.032	0.043
A1	0.020	0.150	0.001	0.006
A2	0.750	0.950	0.030	0.037
b	0.180	0.280	0.007	0.011
c	0.090	0.230	0.004	0.009
D	2.900	3.100	0.114	0.122
e	0.50(BSC)		0.020(BSC)	
E	2.900	3.100	0.114	0.122
E1	4.750	5.050	0.187	0.199
L	0.400	0.800	0.016	0.031
θ	0°	6°	0°	6°

TSSOP-14

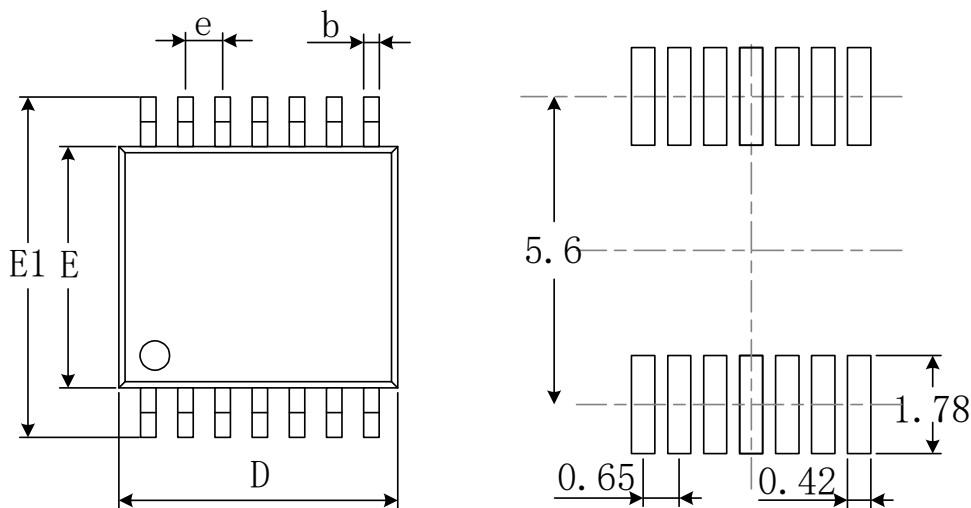

RECOMMENDED LAND PATTERN (Unit: mm)

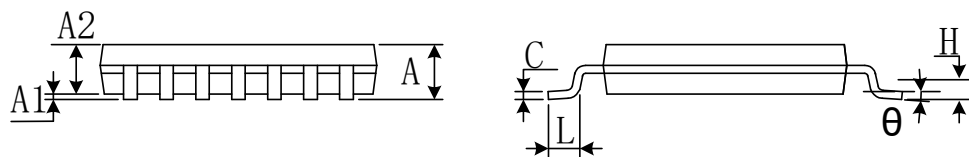

Symbol	Dimensions In Millimeters		Dimensions In Inches	
	Min	Max	Min	Max
A		1.200		0.047
A1	0.050	0.150	0.002	0.006
A2	0.800	1.050	0.031	0.041
b	0.190	0.300	0.007	0.012
c	0.090	0.200	0.004	0.008
D	4.860	5.100	0.191	0.201
E	4.300	4.500	0.169	0.177
E1	6.250	6.550	0.246	0.258
e	0.650(BSC)		0.026(BSC)	
L	0.500	0.700	0.020	0.028
H	0.25(TYP)		0.01(TYP)	
θ	1°	7°	1°	7°

SOIC-8

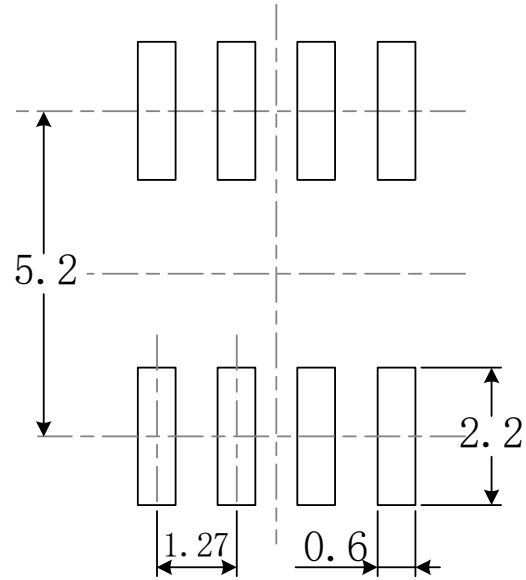
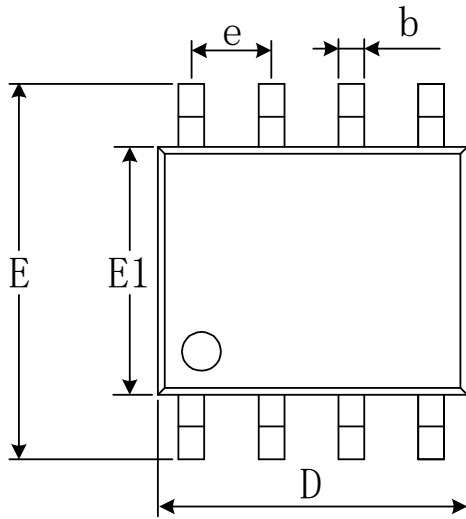

RECOMMENDED LAND PATTERN (Unit: mm)

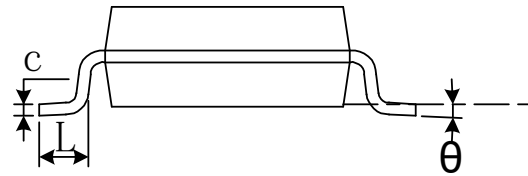
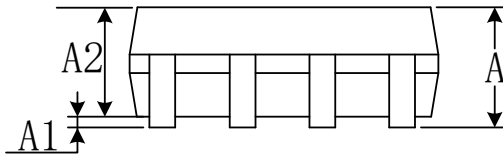

Symbol	Dimensions In Millimeters		Dimensions In Inches	
	Min	Max	Min	Max
A	1.350	1.750	0.053	0.069
A1	0.100	0.250	0.004	0.010
A2	1.350	1.550	0.053	0.061
b	0.330	0.510	0.013	0.020
c	0.170	0.250	0.007	0.010
D	4.800	5.000	0.189	0.197
e	1.270(BSC)		0.050(BSC)	
E	5.800	6.200	0.228	0.244
E1	3.800	4.000	0.150	0.157
L	0.400	1.270	0.016	0.050
θ	0°	8°	0°	8°

SOIC-14

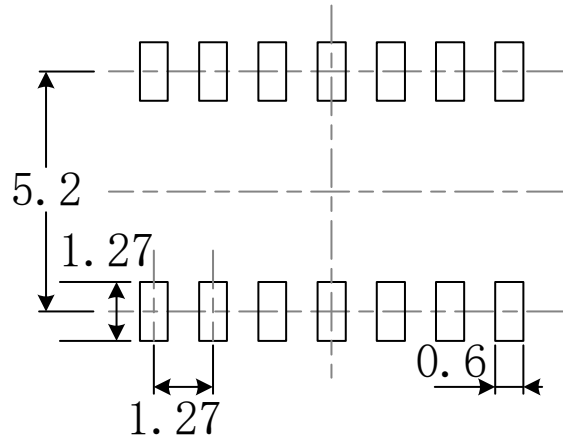
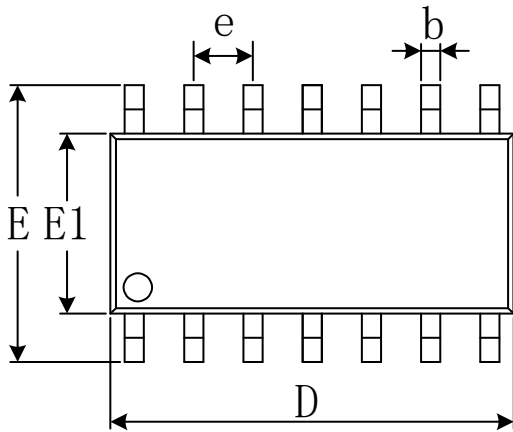

RECOMMENDED LAND PATTERN (Unit: mm)

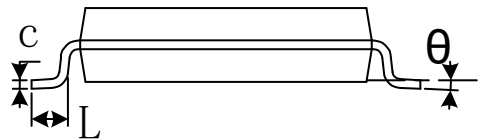
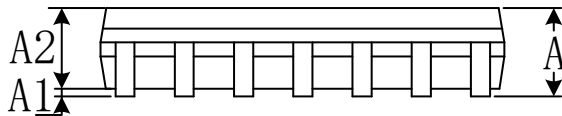

Symbol	Dimensions In Millimeters		Dimensions In Inches	
	Min	Max	Min	Max
A	1.350	1.750	0.053	0.069
A1	0.100	0.250	0.004	0.010
A2	1.350	1.550	0.053	0.061
b	0.310	0.510	0.012	0.020
c	0.100	0.250	0.004	0.010
D	8.450	8.850	0.333	0.348
e	1.270(BSC)		0.050(BSC)	
E	5.800	6.200	0.228	0.244
E1	3.800	4.000	0.150	0.157
L	0.400	1.270	0.016	0.050
θ	0°	8°	0°	8°

TDFN-3x3-8L

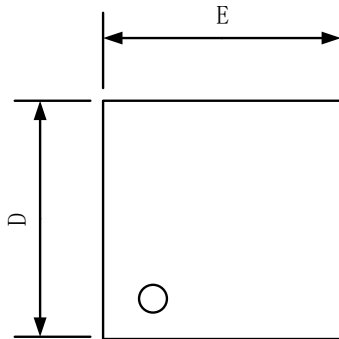

TOP VIEW

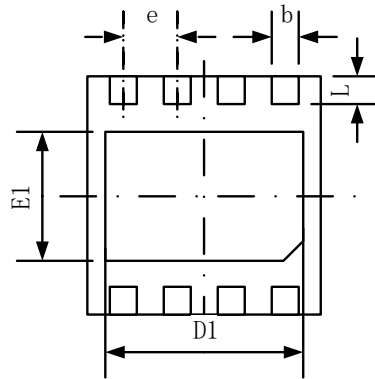

BOTTOM VIEW

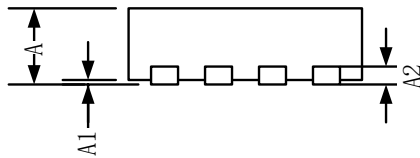

SIDE VIEW

Symbol	Dimensions In Millimeters		Dimensions In Inches	
	Min	Max	Min	Max
A	0.700	0.800	0.028	0.031
A1	0.000	0.050	0.000	0.002
A2	0.203		0.008	
b	0.300	0.400	0.012	0.016
D	2.900	3.100	0.114	0.122
D1	2.510	2.610	0.099	0.103
E	2.900	3.100	0.114	0.122
E1	1.550	1.650	0.061	0.065
e	0.650 TYP		0.026 TYP	
L	0.350	0.450	0.014	0.018