

Features

- ▶ The plastic package carries Underwriters Laboratory Flammability Classification 94V-0
- ▶ For surface mounted applications
- ▶ Metal silicon junction, majority carrier conduction
- ▶ Low power loss, high efficiency
- ▶ Built-in strain relief, ideal for automated placement
- ▶ High forward surge current capability
- ▶ High temperature soldering guaranteed: 260°C/10 seconds at terminals
- ▶ Compliant to RoHS 2.0

Mechanical data

- ▶ **Case:** JEDEC DO-214AC molded plastic body
- ▶ **Terminals:** Solder plated, solderable per MIL-STD-750, Method 2026
- ▶ **Polarity:** Color band denotes cathode end
- ▶ **Mounting Position:** Any

Package outline

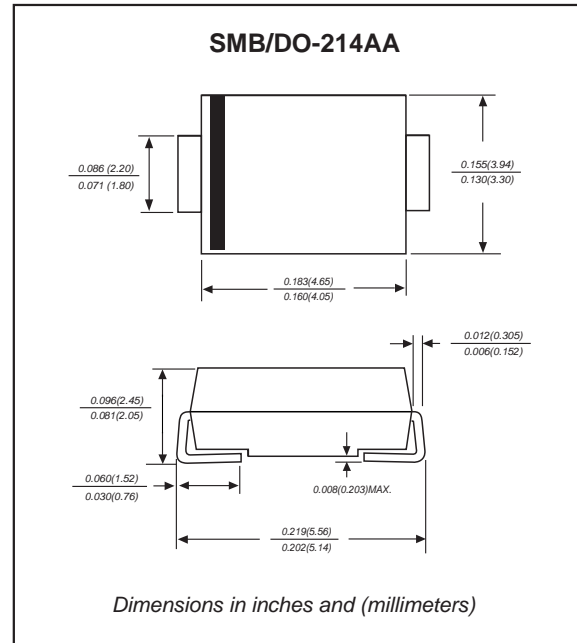

Maximum ratings and Electrical Characteristics (AT $T_A=25^\circ\text{C}$ unless otherwise noted)

	SYMBOLS	SS32B	SS33B	SS34B	SS35B	SS36B	SS38B	SS310B	SS315B	SS320B	UNITS
Maximum repetitive peak reverse voltage	V_{RRM}	20	30	40	50	60	80	100	150	200	V
Maximum RMS voltage	V_{RMS}	14	21	28	35	42	56	70	105	140	V
Maximum DC blocking voltage	V_{DC}	20	30	40	50	60	80	100	150	200	V
Maximum average forward rectified current at T_L (see fig.1)	I_{AV}	3.0									A
Peak forward surge current 8.3ms single half sine-wave superimposed on rated load	I_{FSM}	80.0									A
Maximum instantaneous forward voltage at 3.0A	V_F	0.55		0.70		0.85		0.95			V
Maximum DC reverse current at rated DC blocking voltage	I_R			0.5		0.1					mA
				10.0		5.0		2.0			
Typical junction capacitance (NOTE 1)	C_J	450									pF
Typical thermal resistance (NOTE 2)	$R_{\theta JA}$	60									$^\circ\text{C/W}$
Operating junction temperature range	T_J	-55 to +125			-55 to +150						$^\circ\text{C}$
Storage temperature range	T_{STG}	-55 to +150									$^\circ\text{C}$

Note:1. Measured at 1MHz and applied reverse voltage of 4.0V D.C.
2. P.C.B. mounted with 2.0x2.0" (5.0x5.0cm) copper pad areas

Rating and characteristic curves

AVERAGE FORWARD RECTIFIED CURRENT, AMPERES

FIG. 1- FORWARD CURRENT DERATING CURVE

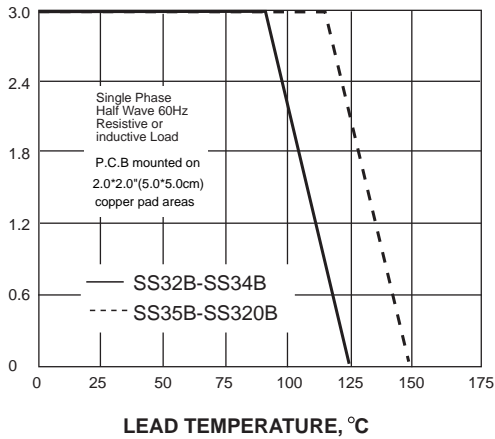

PEAK FORWARD SURGE CURRENT, AMPERES

FIG. 2-MAXIMUM NON-REPETITIVE PEAK FORWARD SURGE CURRENT

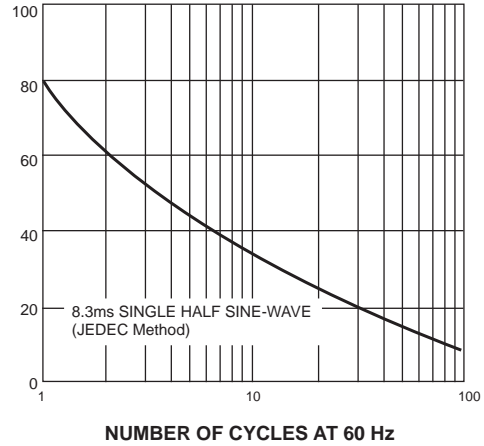

INSTANTANEOUS FORWARD CURRENT, AMPERES

FIG. 3-TYPICAL INSTANTANEOUS FORWARD CHARACTERISTICS

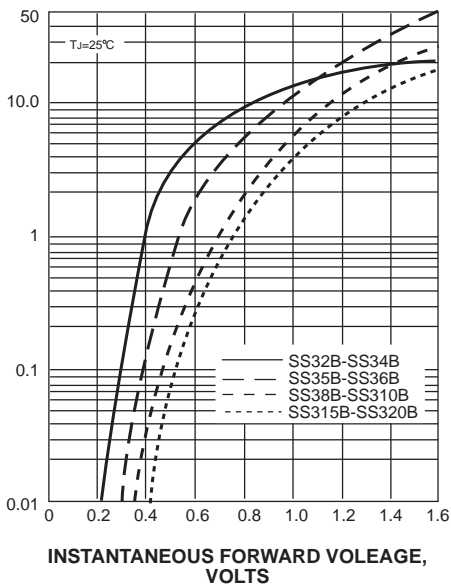

INSTANTANEOUS REVERSE CURRENT, MILLIAMPERES

FIG. 4-TYPICAL REVERSE CHARACTERISTICS

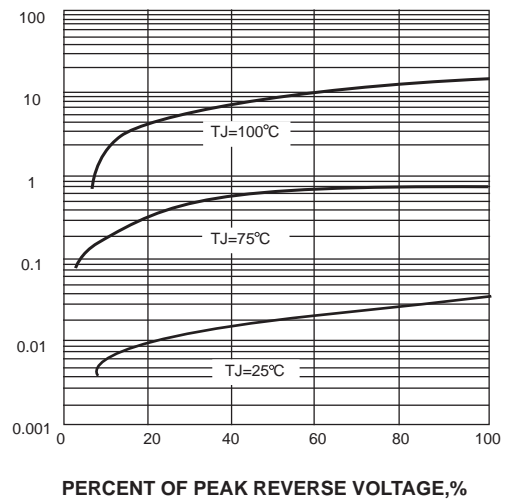

JUNCTION CAPACITANCE, pF

FIG. 5-TYPICAL JUNCTION CAPACITANCE

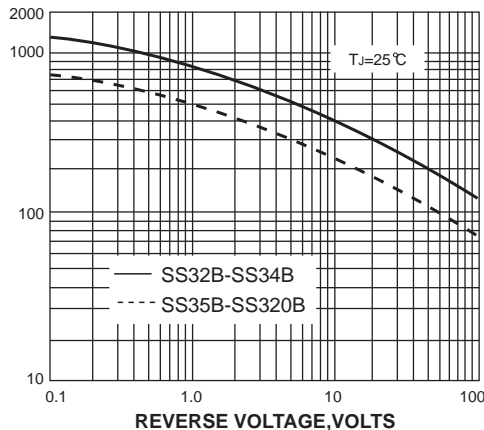

TRANSIENT THERMAL IMPEDANCE, °C/W

FIG. 6-TYPICAL TRANSIENT THERMAL IMPEDANCE

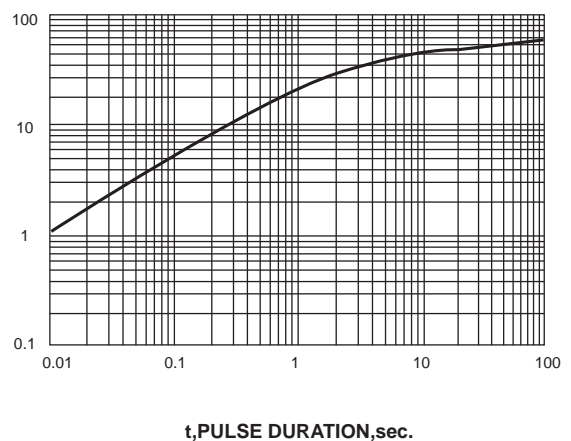

Pinning information

Pin	Simplified outline	Symbol
Pin1 cathode Pin2 anode		

Marking

Type number	Marking code	Example
SS32B	SS32	
SS33B	SS33	
SS34B	SS34	
SS35B	SS35	
SS36B	SS36	
SS38B	SS38	
SS310B	SS310	
SS315B	SS315	
SS320B	SS320	

Suggested solder pad layout

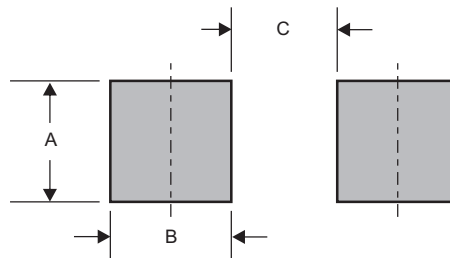

Dimensions in inches and (millimeters)

PACKAGE	A	B	C
SMB	0.078 (2.00)	0.059 (1.50)	0.110 (2.80)

Suggested thermal profiles for soldering processes

- 1.Storage environment: Temperature=5°C~40°C Humidity=55%±25%
- 2.Reflow soldering of surface-mount devices

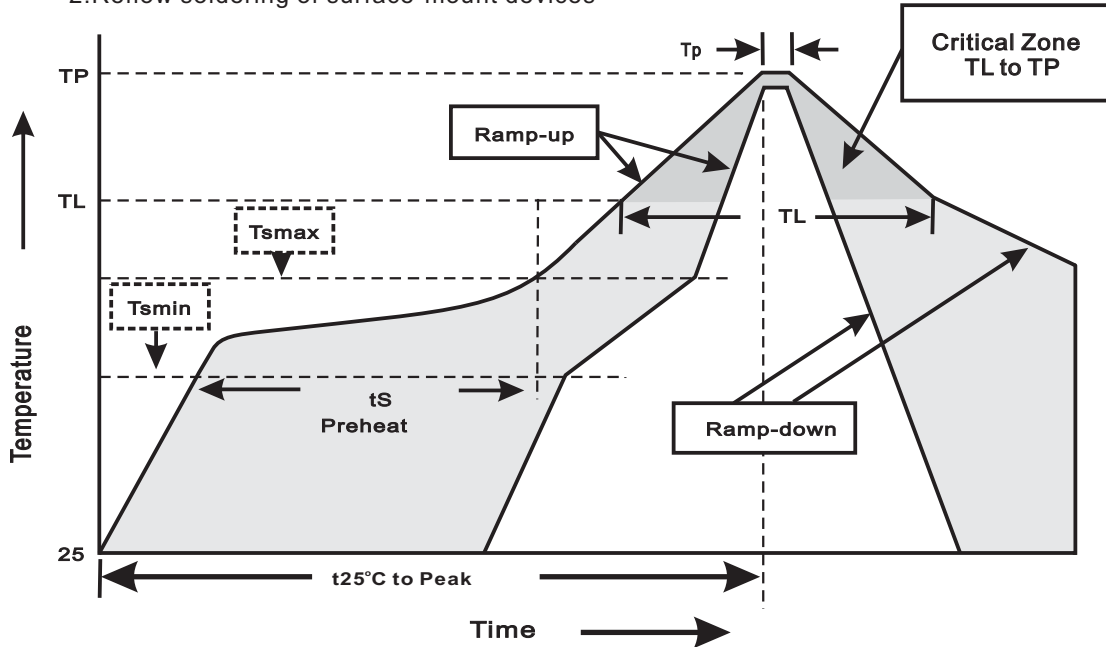

3.Reflow soldering

Profile Feature	Soldering Condition
Average ramp-up rate(TL to TP)	<3°C/sec
Preheat -Temperature Min(Tsmin) -Temperature Max(Tsmax) -Time(min to max)(ts)	150°C 200°C 60~120sec
Tsmax to TL -Ramp-upRate	<3°C/sec
Time maintained above: -Temperature(TL) -Time(tL)	217°C 60~260sec
Peak Temperature(TP)	255°C-0/+5°C
Time within 5°C of actual Peak Temperature(tp)	10~30sec
Ramp-down Rate	<6°C/sec
Time 25°C to Peak Temperature	<6minutes