

# SPECIFICATION FOR APPROVAL

CUSTOMER : \_\_\_\_\_

PRODUCT TYPE : SMD SEAM SEALING CXO 3.2 × 2.5

NOMINAL FREQ. : 25.000000MHz

TXC P/N : 7X25000009

REVISION : A1

CUSTOMER P/N : \_\_\_\_\_

PM / SALES : \_\_\_\_\_

DATE : \_\_\_\_\_

CUSTOMER SIGNATURE & Date

\_\_\_\_\_

\_\_\_\_\_

- (1) TXC requires one copy returned with signature and title of authorized individual that signifies acceptance of the attached specifications.
- (2) Orders received and accepted by TXC after return of signed copy of specification will be produced per these specifications.
- (3) Any changes to these specifications must be agreed upon by both parties and new revision of the Product Specification Sheet will be issued.
- (4) Any issuance of purchase order prior to consigning back the Approval page of "Specification Sheets" from customers will be regarded as the agreement on the contents of these specifications.

Attachment: Product Specification Sheet

- 1
- 2
- 3
- 4
- 5

**RoHS Compliant**



**TXC CORPORATION**

4F, NO. 16, Sec. 2 Chung Yang S Rd., Peitou, Taipei, Taiwan.

TEL : 886-2-2894-1202 , 886-2-2895-2201 FAX : 886-2-2894-1206 , 886-2-2895-6207

www.txccorp.com



# PRODUCT SPECIFICATION SHEET

PRODUCT TYPE : SMD SEAM SEALING CXO 3.2 × 2.5

NOMINAL FREQ. : 25.000000MHz

TXC P/N : 7X25000009

REVISION : A1

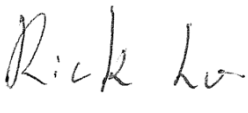
PE/RD	QA	MFG
		
31-May-10	4-Jun-10	1-Jun-10

**NOTE:**

- (1)Lead Free Products are "Directive 2002/95/EC of The European Parliament of 27 January 2003 on the restriction of the use of certain hazardous substances (RoHS) in electrical and electronic equipment" Compliant (Attachment: SGS Test Report).
- (2)Revision "Sx" is for engineering samples only. PE/RD's approval required.
- (3)Revision "Ax" is production ready. PE, QA and MFG's approval required.

**RoHS Compliant**



<u>Rev</u>	<u>Revise page</u>	<u>Revise contents</u>	<u>Date</u>	<u>Ref.No.</u>	<u>Reviser</u>
A1	N/A	Initial released	27-May-10	N/A	Yachuan Miao

## ■ ELECTRICAL SPECIFICATIONS

### Standard atmospheric conditions

Unless otherwise specified, the standard range of atmospheric conditions for making measurement and tests are as follow:

Ambient temperature :  $25\pm 5^{\circ}\text{C}$   
 Relative humidity : 40%~70%

If there is any doubt about the results, measurement shall be made within the following limits:

Ambient temperature :  $25\pm 3^{\circ}\text{C}$   
 Relative humidity : 40%~70%

### Measure equipment

Electrical characteristics measured by MD 37WX-05M or equivalent.

### Crystal cutting type

The crystal is using AT CUT (thickness shear mode).

### Unit Weight:

0.025±0.002 g/pcs

	Parameters	Symbol	Electrical Spec.				Notes
			Min.	Typ.	Max.	Units	
1	Nominal Frequency	-	25.000000			MHz	-
2	Frequency Stability	-	±25			ppm	-
3	Operating Temperature	Topr	-10	25	70	°C	-
4	Storage Temperature	Tstg	-55	~	125	°C	-
5	Supply Voltage	VDD	1.8 ±10%			V	-
6	Input Current	Icc	-	-	10	mA	-
7	Enable Control	-	Yes			-	Pad 1
8	Output Load : CMOS	CL	15			pF	-
9	Output Voltage High	VoH	90%Vdd	-	-	V	-
10	Output Voltage Low	VoL	-	-	10%Vdd	V	-
11	Rise Time	Tr	-	-	10	ns	10%→90%VDD Level
12	Fall Time	Tf	-	-	10	ns	90%→10%VDD Level
13	Symmetry (Duty ratio)	TH/T	45	~	55	%	-
14	Start-up Time	Tosc	-	-	10	ms	-
15	Enable Voltage High	Vhi	70%Vdd	-	-	V	-
16	Disable Voltage Low	Vlo	-	-	30%Vdd	V	-
17	Aging	-	±3			ppm/yr.	1st. Year at 25°C
18	Output Disable Delay Time	T off	-	-	150	us	-
19	Output Enable Delay Time	T on	-	-	150	us	-

**■ DIMENSIONS**

(Unit:mm)

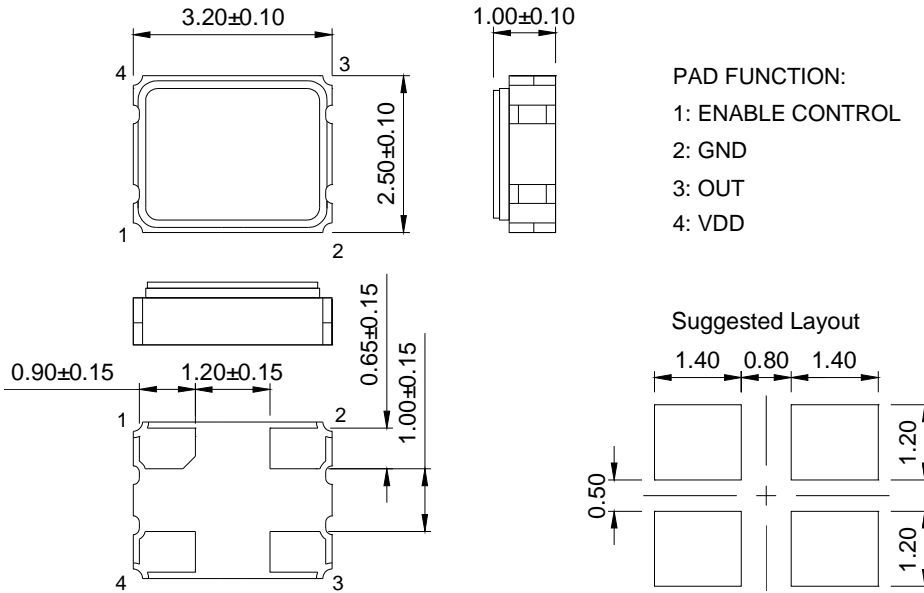

- PAD FUNCTION:
- 1: ENABLE CONTROL
  - 2: GND
  - 3: OUT
  - 4: VDD

**■ MARKING**

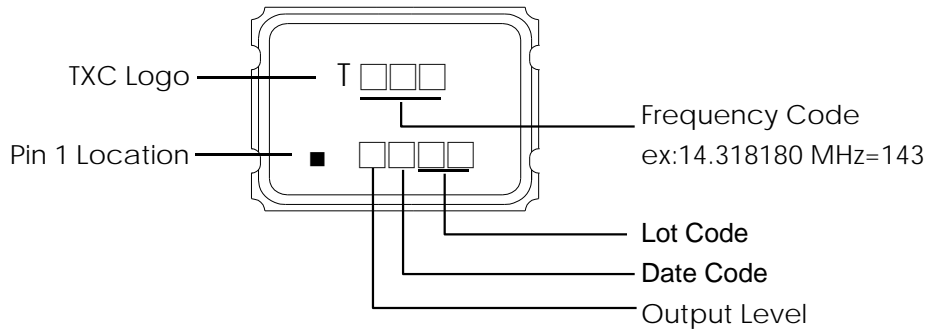

Output Level:

VDD(V)	5	3.3	2.8	2.5	1.8	2.9	3.0	2.85	2.6	2.55	2	1.5	2.7	3.4
CODE	A	B	C	D	E	F	G	H	J	K	L	M	N	P

Date Code:

YEAR				MONTH											
				JAN	FEB	MAR	APR	MAY	JUN	JUL	AUG	SEP	OCT	NOV	DEC
2005	2009	2013	2017	A	B	C	D	E	F	G	H	J	K	L	M
2006	2010	2014	2018	N	P	Q	R	S	T	U	V	W	X	Y	Z
2007	2011	2015	2019	a	b	c	d	e	f	g	h	j	k	l	m
2008	2012	2016	2020	n	p	q	r	s	t	u	v	w	x	y	z

\*This date code will be cycled every four years

Production location: Taiwan

**TEST DIAGRAM**

Control input (output enable/disable)  
 Logic 1 or open on pad 1: Oscillator output  
 Logic 0 on pad 1 : Disable output to high impedance

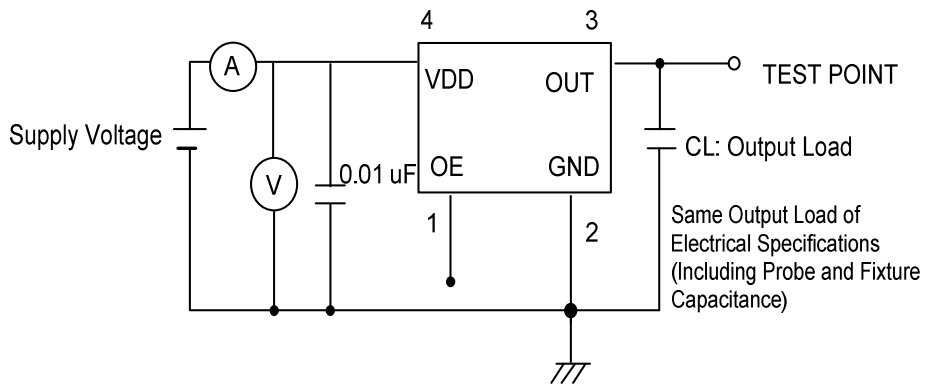

**WAVEFORM CONDITIONS**

Waveform measurement system should have a min. bandwidth of 5 times the frequency being tested.

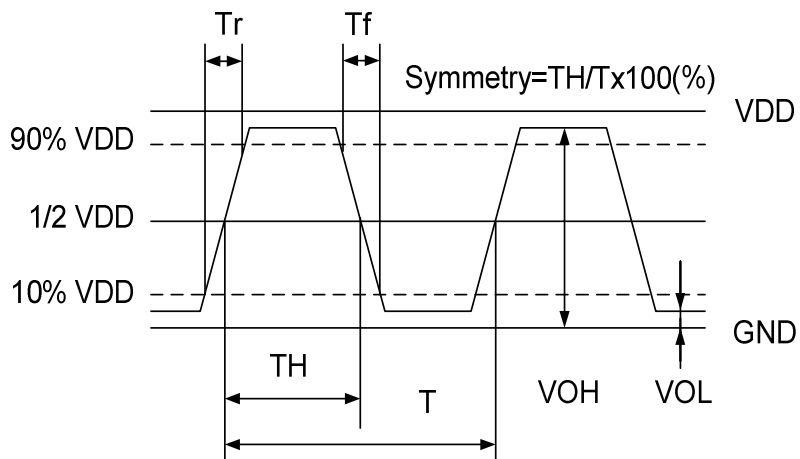

**OUTPUT ENABLE / DISABLE DELAY**

The following figure shows the oscillator timing during normal operation . Note that when the device is in standby, the oscillator stops. When standby is released, the oscillator starts and stable oscillator output occurs after a short delay.

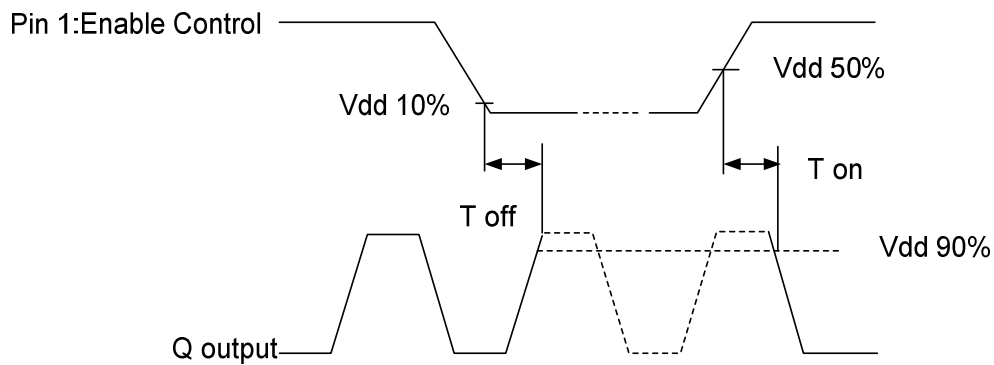

**SUGGESTED REFLOW PROFILE**

Total time : 200 sec. Max.  
Solder melting point :220 °C

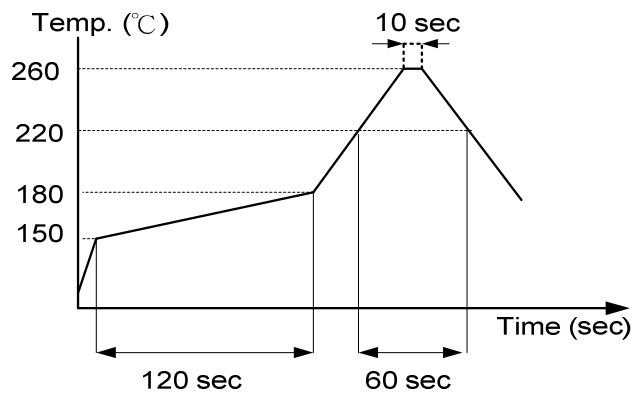

■ STRUCTURE ILLUSTRATION

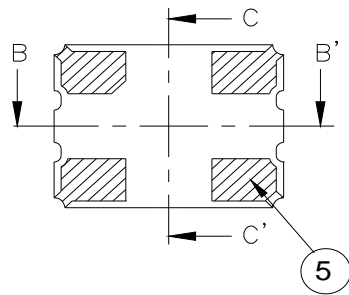
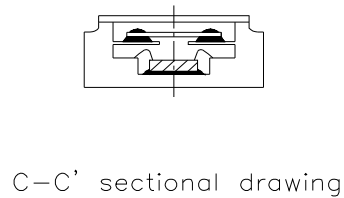
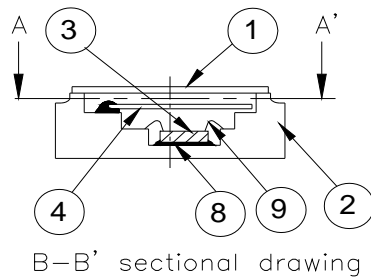
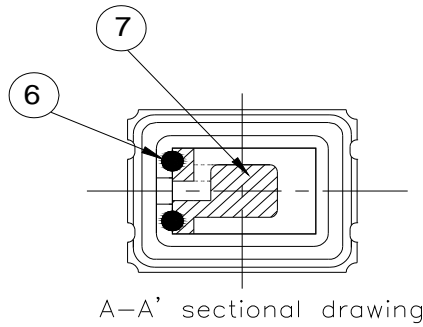

NO	COMPONENTS	MATERIALS	FINISH/SPECIFICATIONS
1	Lid	Kovar (Fe/Co/Ni)	-
2	Base (Package)	Ceramic (Al <sub>2</sub> O <sub>3</sub> ) + Kovar (Fe/Co/Ni)+ Ag/Cu	-
3	IC chip	-	-
4	Crystal blank	SiO <sub>2</sub>	-
5	PAD	Au	Tungsten metalize + Ni plating + Au plating
6	Conductive adhesive	Ag	Silicon resin
7	Electrode	Noble Metal	-
8	Die attached	Conductive (Ag)	Epoxy resin
9	Bonding wire	Au	Pad 1 options : NC is 5 wires , EN is 6 wires.



■ PACKING

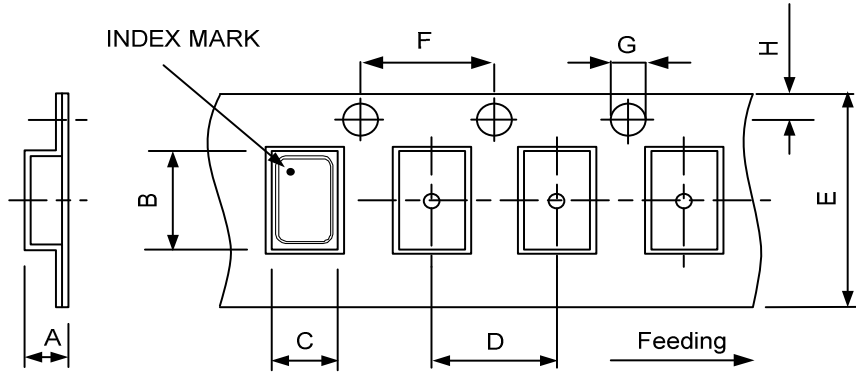

DIMENSIONS	A	B	C	D	E	F	G	H	(UNIT : mm)
	1.65	3.4	2.7	4	8	4	1.55	1.75	

REMARK :

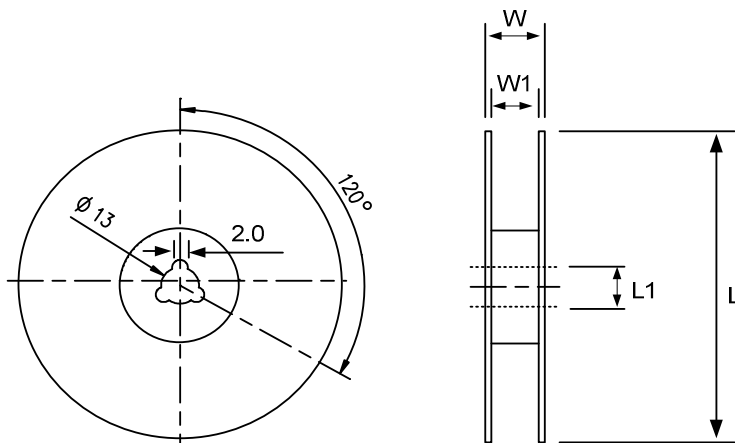
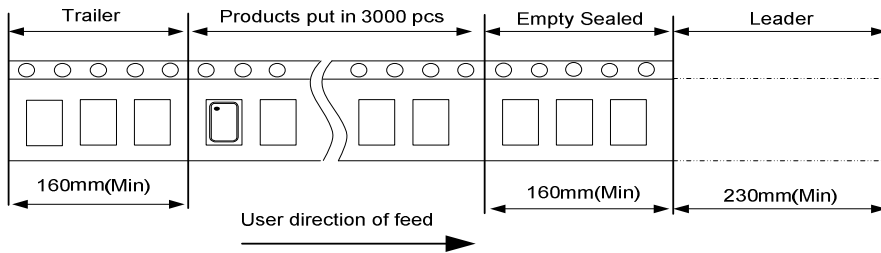

DIMENSIONS	L	L1	W	W1	pcs / Reel (UNIT : mm)
	178	13	11.5	8	Standard Reel Quantity is 3,000 pcs per reel

■ RELIABILITY SPECIFICATIONS

1.Mechanical Endurance

No.	Test Item	Test Methods	REF. DOC
1	Drop Test	75 cm height,3 times on concrete floor .	JIS C6701
1	Mechanical Shock	Device are shocked to half sine wave ( 1000 G ) three mutually perpendicular axes each 3 times. 0.5m sec. duration time	MIL-STD-202
1	Vibration	Frequency range 10 ~ 2000 Hz Amplitude 1.52 mm/20G Sweep time 20 minutes perpendicular axes each test time 4 Hrs (Total test time 12 Hrs)	MIL-STD-883
1	Gross Leak	Standard Sample For Automatic Gross Leak Detector, Test Pressure: 2kg / cm <sup>2</sup>	MIL-STD-883
2	Fine Leak	Helium Bomgng 4.5 kgf / cm <sup>2</sup> for 2 Hrs	
2	Solderability	Temperature 245 °C ± 5°C Immersing depth 0.5 mm minimum Immersion time 5 ± 1 seconds Flux Rosin resin methyl alcohol solvent ( 1 : 4 )	MIL-STD-883

2.Environmental Endurance

No.	Test Item	Test Methods	REF. DOC
2	Resistance To Soldering Heat	Pre-heat temperature 125 °C Pre-heat time 60 ~ 120 sec. Test temperature 260 ± 5 °C Test time 10 ± 1 sec.	MIL-STD-202
2	High Temp. Storage	+ 125 °C ± 3 °C for 1000 ± 12 Hrs	MIL-STD-883
2	Low Temp. Storage	- 40 °C ± 3 °C for 1000 ± 12 Hrs	
2	Thermal Shock	Total 100 cycles of the following temperature cycle  	MIL-STD-883
3	High Temp & Humidity	85°C ± 3°C, RH 85% , 1000 Hrs	JIS C5023
3	Pressure Cooker Storage	121 ± 3°C , RH100% , 2 bar , 240 Hrs	JIS C6701