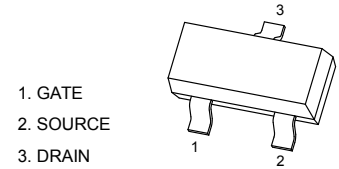

SOT-23 Plastic-Encapsulate MOSFETS
20V P-Channel MOSFET

$V_{(BR)DSS}$	$R_{DS(on)Typ}$	$I_D Max$
-20V	37mΩ@ -4.5V	-4.8A
	43mΩ@ -3.3V	

SOT-23

FEATURE

- Excellent $R_{DS(ON)}$, low gate charge, low gate voltages

APPLICATION

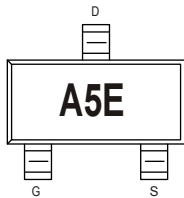
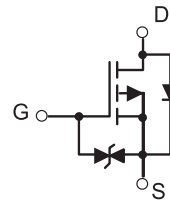
- Load switch and in PWM applications

MARKING

Equivalent circuit

PACKAGE SPECIFICATIONS

Package	Reel Size	Reel DIA. (mm)	Q'TY/Reel (pcs)	Box Size (mm)	QTY/Box (pcs)	Carton Size (mm)	Q'TY/Carton (pcs)
SOT-23	7'	178	3000	203×203×195	45000	438×438×220	180000

Maximum Ratings and Thermal Characteristics (TA = 25°C unless otherwise noted)

Parameter	Symbol	Limit	Unit	
Drain-Source Voltage	$V_{(BR)DSS}$	-20	V	
Gate-Source Voltage	V_{GS}	±8		
Continuous Drain Current	I_D	$T_A = 25^\circ C$	-4.8	A
		$T_A = 70^\circ C$	-3.6	
Pulsed Drain Current ¹⁾	I_{DM}	-30	A	
Maximum Power Dissipation ²⁾	P_D	$T_A = 25^\circ C$	1.5	W
		$T_A = 70^\circ C$	1.0	
Operating Junction and Storage Temperature Range	T_J, T_{stg}	-50 to 150	°C	
Junction-to-Ambient Thermal Resistance (PCB mounted) ²⁾	R_{thJA}	80	°C/W	

Notes

- ¹⁾ Pulse width limited by maximum junction temperature.
²⁾ Surface Mounted on FR4 Board, $t \leq 5$ sec.

The above data are for reference only.



MOSFET ELECTRICAL CHARACTERISTICS

$T_a=25\text{ }^\circ\text{C}$ unless otherwise specified

Parameter	Symbol	Test Condition	Min	Typ	Max	Units
Static Parameters						
Drain-source breakdown voltage	$V_{(BR)DSS}$	$V_{GS} = 0V, I_D = -250\mu A$	-20			V
Gate threshold voltage	$V_{GS(th)}$	$V_{DS} = V_{GS}, I_D = -250\mu A$	-0.4	-0.7	-1.2	
Zero gate voltage drain current	I_{DSS}	$V_{DS} = 20V, V_{GS} = 0V (T_A=25\text{ }^\circ\text{C})$			-1	μA
		$V_{DS} = 16V, V_{GS} = 0V (T_A=125\text{ }^\circ\text{C})$			-100	
Gate-body leakage current	I_{GSS}	$V_{DS} = 0V, V_{GS} = \pm 8V$			± 10	
Drain-source on-state resistance(note1)	$R_{DS(on)}$	$V_{GS} = -4.5V, I_D = -4A$		37	45	m Ω
		$V_{GS} = -3.3V, I_D = -3A$		43	55	
		$V_{GS} = -2.5V, I_D = -2A$		52	65	
Forward transconductance(note2)	g_{FS}	$V_{DS} = -5V, I_D = -4A$	8			S
Dynamic Parameters (note3)						
Input capacitance	C_{iss}	$V_{DS} = -10V, V_{GS} = 0V, f = 1MHz$		675		pF
Output capacitance	C_{oss}			120		
Reverse transfer capacitance	C_{rss}			85		
Gate resistance	R_g	$V_{DS} = 0V, V_{GS} = 0V, f = 1MHz$		6.5		Ω
Switching Parameters						
Total gate charge	Q_g	$V_{DS} = -10V, V_{GS} = -4.5V, I_D = -4A$		14.2		nC
Gate-Source charge	Q_{gs}			3.2		
Gate-drain charge	Q_{gd}			5.8		
Turn-on delay time (note3)	$t_{d(on)}$	$V_{DS} = -10V, V_{GS} = -4.5V$ $R_{GEN} = 3\Omega, R_L = 2.5\Omega,$		15		ns
Turn-on rise time(note3)	t_r			11		
Turn-off delay time(note3)	$t_{d(off)}$			22		
Turn-off fall time(note3)	t_f			35		
Drain-source body diode characteristics						
Continuous source-drain diode current	I_S	$T_C = 25\text{ }^\circ\text{C}$			-2.0	A
Body diode voltage (note 2)	V_{SD}	$I_S = -2A, V_{GS} = 0V$		-0.83	-1.2	V

Notes:

- 1) PRRepetitive rating, pulse width limited by junction temperature.
- 2) Pulse test: pulse width $\leq 300\mu s$, duty cycle $\leq 2\%$.
- 3) These parameters have no way to verify.

Typical Characteristics

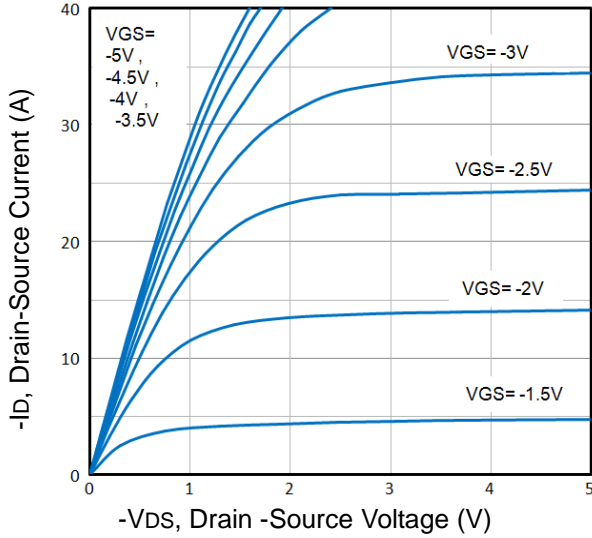

Fig1. Typical Output Characteristics

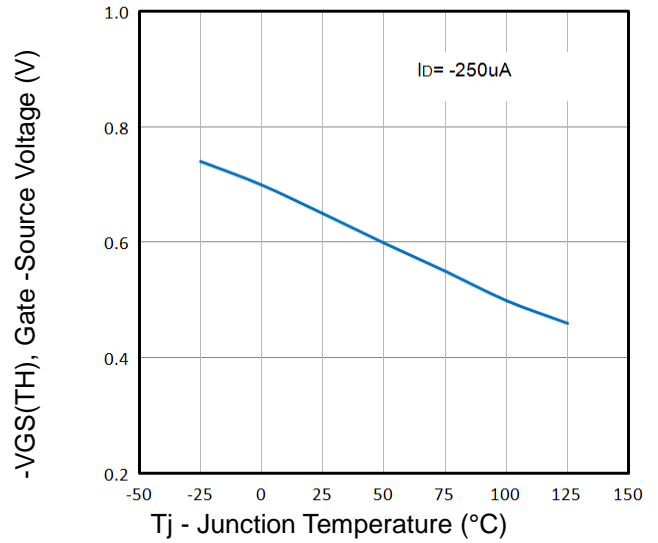

Fig2. Normalized Threshold Voltage Vs. Temperature

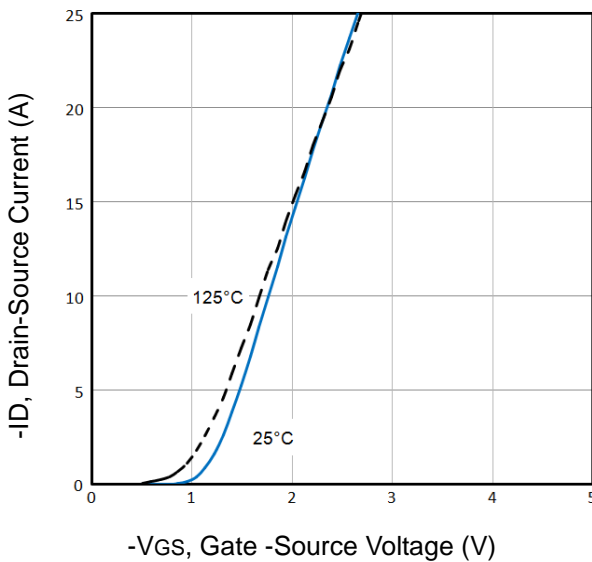

Fig3. Typical Transfer Characteristics

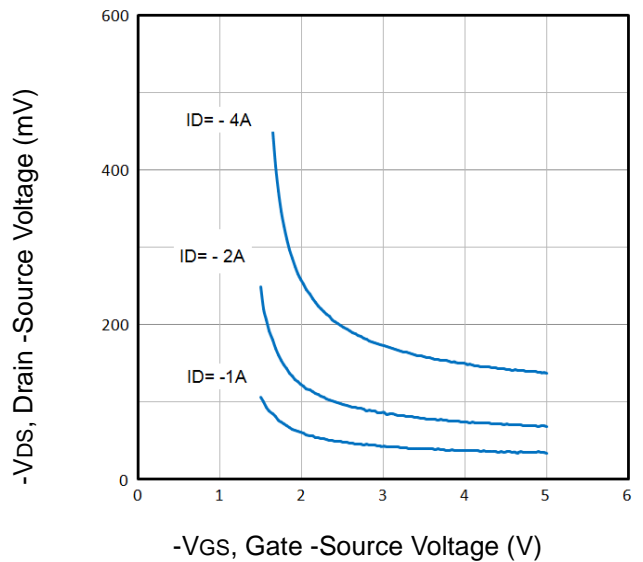

Fig4. Drain-Source Voltage vs Gate-Source Voltage

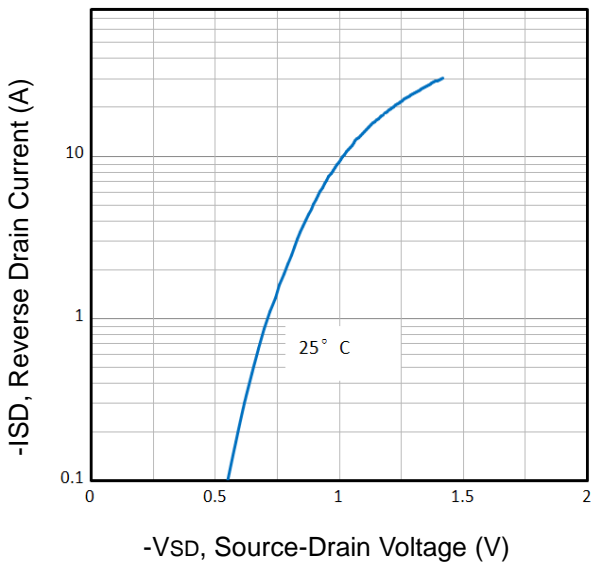

Fig5. Typical Source-Drain Diode Forward Voltage

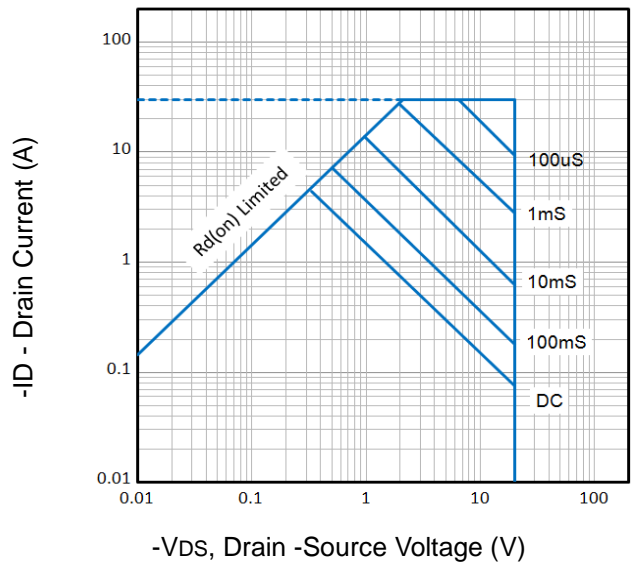

Fig6. Maximum Safe Operating Area

Typical Characteristics

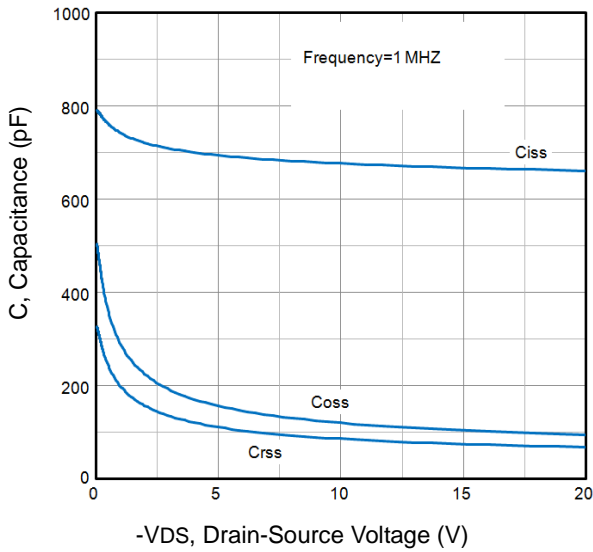

Fig7. Typical Capacitance Vs. Drain-Source Voltage

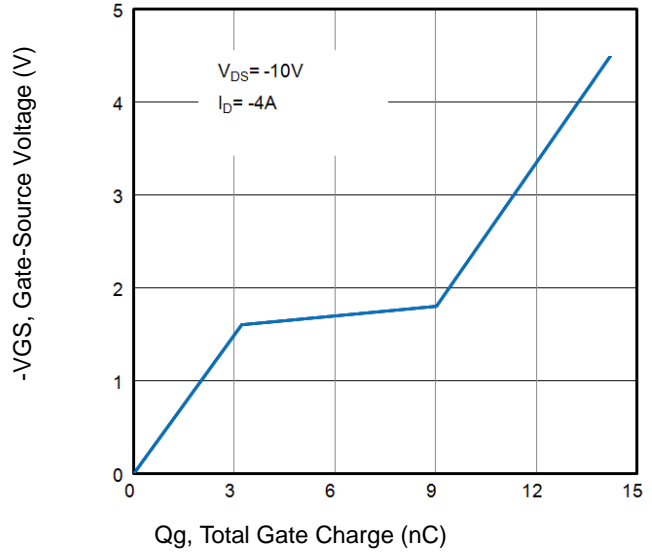

Fig8. Typical Gate Charge Vs. Gate-Source Voltage

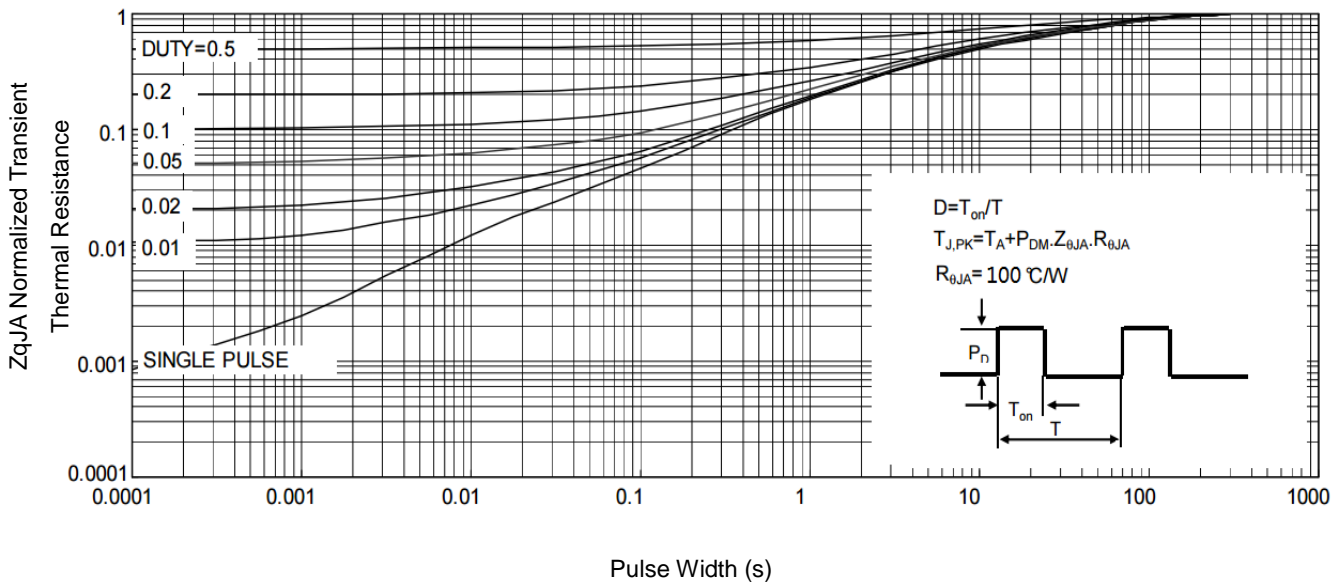

Fig9. Normalized Maximum Transient Thermal Impedance

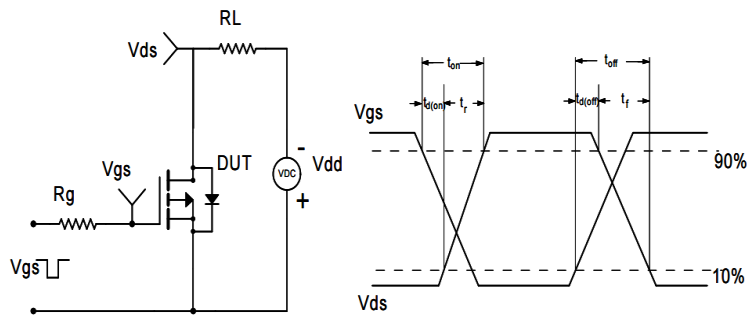
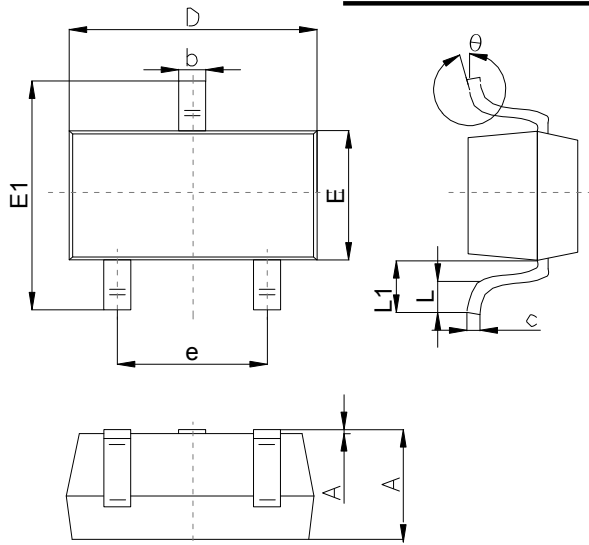

Fig10. Switching Time Test Circuit and waveforms

Outlitne Drawing

SOT-23 Package Outline Dimensions



Symbol	Dimensions In Millimeters		
	Min	Typ	Max
A	1.00		1.40
A1			0.10
b	0.35		0.50
c	0.10		0.20
D	2.70	2.90	3.10
E	1.40		1.60
E1	2.4		2.80
e		1.90	
L	0.10		0.30
L1	0.4		
θ	0°		10°

Suggested Pad Layout

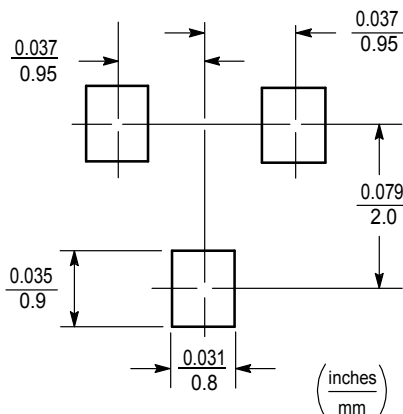

Note:

1. Controlling dimension:in/millimeters. 2.General tolerance: $\pm 0.05\text{mm}$.
- 3.The pad layout is for reference purposes only.

Important Notice and Disclaimer

Microdiode Electronics (Jiangsu) reserves the right to make changes to this document and its products and specifications at any time without notice. Customers should obtain and confirm the latest product information and specifications before final design,purchase or use.

Microdiode Electronics (Jiangsu) makes no warranty, representation or guarantee regarding the suitability of its products for any particular purpose, not does Microdiode Electronics (Jiangsu) assume any liability for application assistance or customer product design. Microdiode Electronics (Jiangsu) does not warrant or accept any liability with products which are purchased or used for any unintended or unauthorized application.

No license is granted by implication or otherwise under any intellectual property rights of Microdiode Electronics (Jiangsu).

Microdiode Electronics (Jiangsu) products are not authorized for use as critical components in life support devices or systems without express written approval of Microdiode Electronics (Jiangsu).