

XC6230 Series

Adjustable Voltage Output Multifunction 2A High Speed LDO Regulator

ETR03084-006

■ GENERAL DESCRIPTION

The XC6230 series are low on-resistance / low dropout voltage, highly precise, low noise, high PSRR, and large current High Speed LDO regulator IC. A built-in 0.17Ω low ON-resistance Pch driver transistor which can output up to a maximum output current 2.0A are also enclosed in a small surface-mount PKG, even in applications that input and output voltage difference is you use a very small state, it is possible to use in the space-saving.

Then, the output voltage is possible to set the output voltage value to 1.2V ~ 5.0V by connecting the external resistors to V_{OFB} terminal.

The over current protection circuit will operate when the output current reaches its current limit. The thermal shutdown circuit will operate when the junction temperature reaches its limit temperature. The current limit is possible to arbitrarily set in a range of external resistor in 0.3 ~ 2.5A to I_{LIM} terminal. The inrush current prevention circuit perform the function of suppressing the variation of the V_{IN} line and It is possible to suppress the current (inrush current), which is charged in the output capacitor (C_L) during IC start rising (when the IC control in CE). In addition, the CE function enables the output to be turned off and the IC becomes a stand-by mode resulting in greatly reduced power consumption.

When in standby mode, the output capacitor (C_L) to be discharged at high speed it can be returned to the V_{SS} level. The IC has further built-in reverse current prevention circuit, to prevent backflow current when the voltage state of more than input terminal (V_{IN}) to the output terminal (V_{OUT}).

■ APPLICATIONS

- Industrial equipment
- Mobile modules
- Wireless modules

■ FEATURES

- | | | |
|------------------------------------|---|---|
| Output current | : | 2.0A |
| Current Limit setting range | : | 0.3A ~ 2.5A |
| Dropout Voltage(USP-6C) | : | 0.17V @ I _{OUT} =1.0A / V _{OUT_SET} =3.3V |
| Dropout Voltage(SOP-8FD) | : | 0.23V @ I _{OUT} =1.0A / V _{OUT_SET} =3.3V |
| Input voltage range | : | 1.7 ~ 6.0V |
| Adjustable Output Voltage Accuracy | : | 1.2V ±1.0% |
| Output voltage setting range | : | 1.2V ~ 5.0V |
| Supply current | : | 45μA |
| Addition function | : | Reverse Current Protection(Optional)
Inrush Current Protection
Output Voltage adjustable
C _L High Speed Discharge(H type)
Current Limit adjustable |
| Protection function | : | Thermal shutdown
(Detection Temp: 150°C
Release Temp: 125°C)
Current limit |
| Output capacitor | : | Ceramic capacitor (4.7μF) |
| Operating Ambient Temperature | : | -40°C ~ +105°C |
| Packages | : | USP-6C, SOP-8FD |
| Environment friendly features | : | EU RoHS Directive compliant, Pb free |

■ TYPICAL APPLICATION CIRCUIT

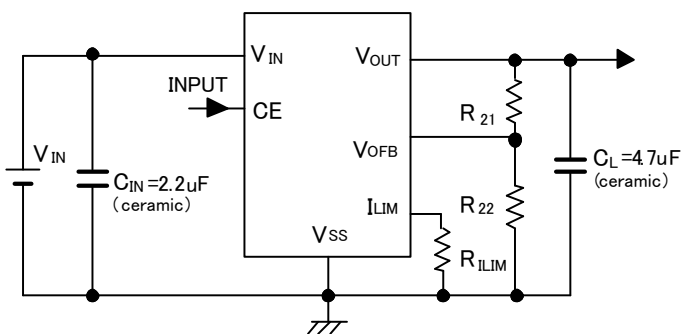

■ TYPICAL PERFORMANCE CHARACTERISTICS

Output Voltage vs. Output Current (Output current externally adjusted.)

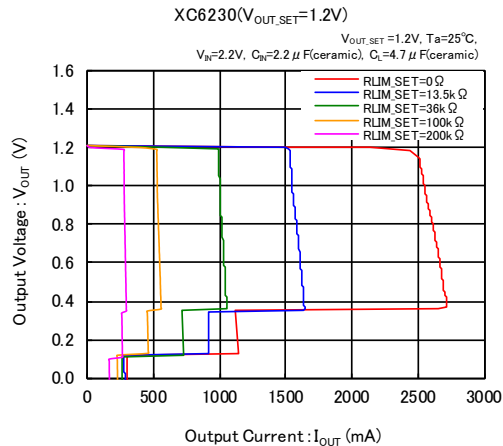

■ BLOCK DIAGRAMS

●XC6230 series, Type H

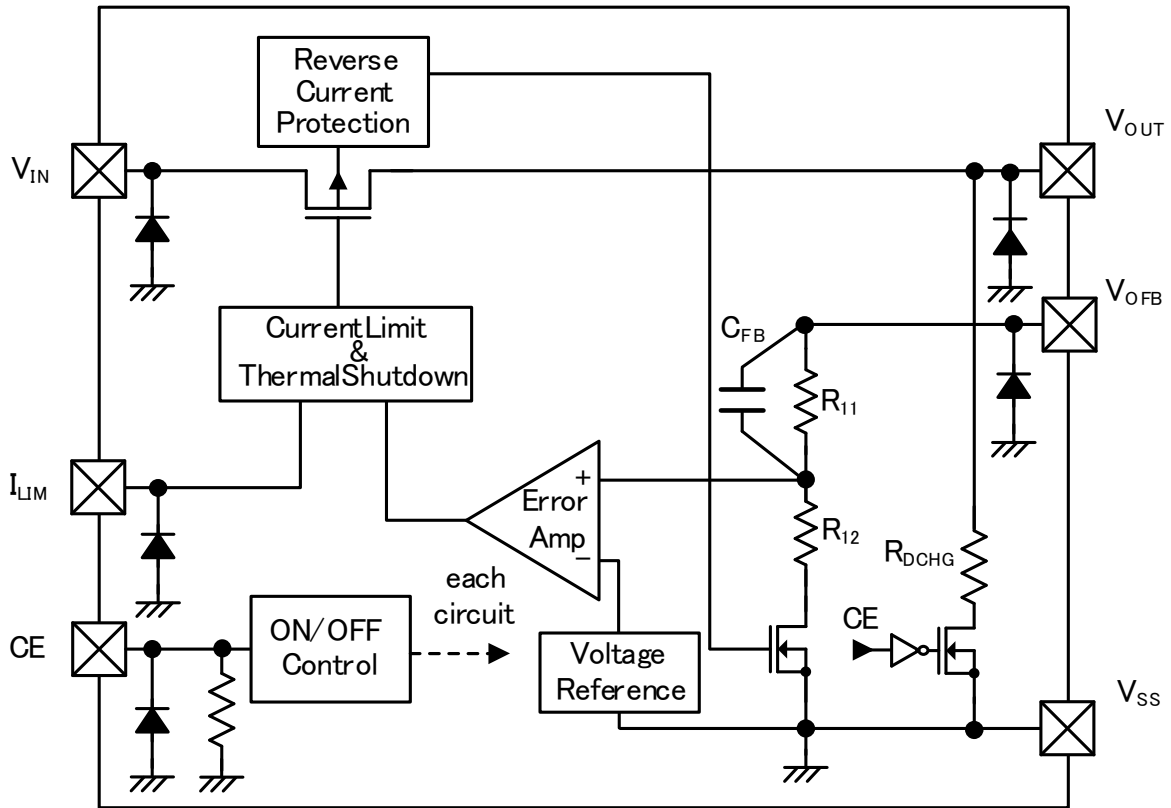

*Diodes inside the circuit are an ESD protection diodes.

●XC6230 series, Type S

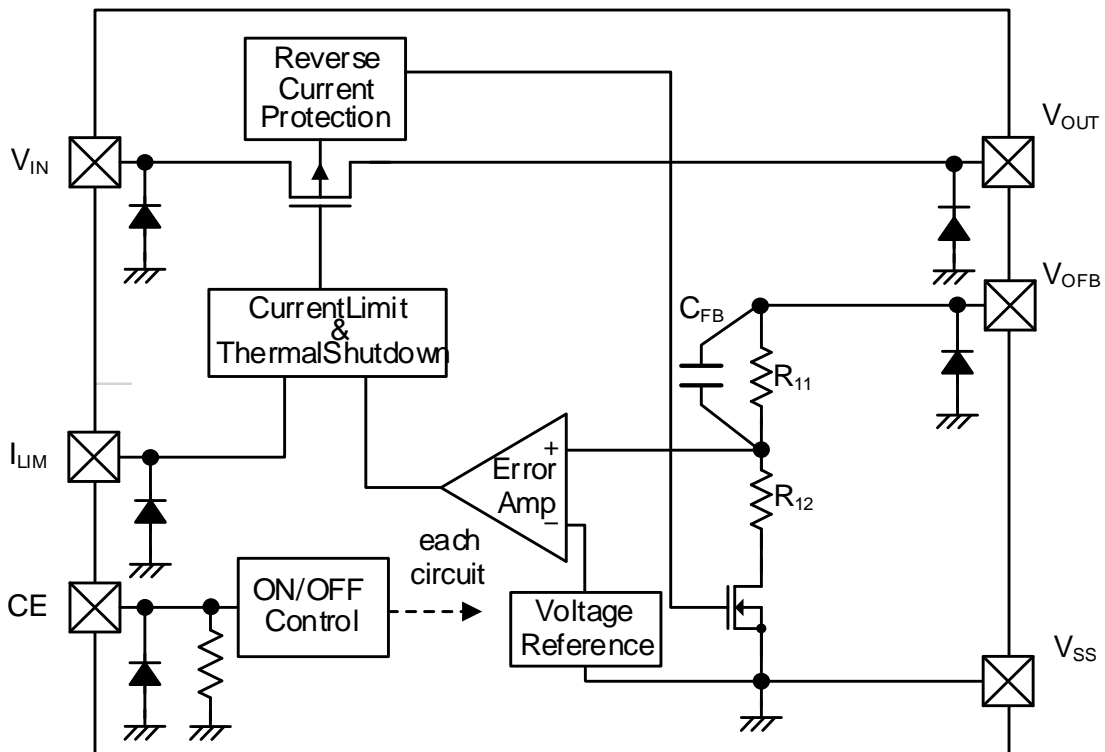

*Diodes inside the circuit are an ESD protection diodes.

A2 **PRODUCT CLASSIFICATION**

● Ordering Information

XC6230①②③④⑤⑥-⑦^(*)

DESIGNATOR	ITEM	SYMBOL	DESCRIPTION
①	Type	H	Refer to Selection Guide
		S	
②③	Output Voltage	00	Adjustable Output Voltage (V _{OFB} =1.20V)
④	Adjustable Output Voltage Accuracy	1	±1%
⑤⑥-⑦ ^(*)	Packages (Order Unit)	ER-G	USP-6C (3,000pcs/Reel)
		QR-G	SOP-8FD (1,000pcs/Reel)

^(*) The “-G” suffix denotes Halogen and Antimony free as well as being fully EU RoHS compliant.

● Selection Guide

TYPE	THERMAL SHUTDOWN	ADJUSTABLE CURRENT LIMITER	ADJUSTABLE OUTPUT VOLTAGE	REVERSE CURRENT PROTECTION
H	Yes	Yes	Yes	Yes
S	Yes	Yes	Yes	Yes

TYPE	INRUSH CURRENT PROTECTION	CE PULL-DOWN RESISTOR	C _L AUTO-DISCHARGE
H	Yes	Yes	Yes
S	Yes	Yes	No

PIN CONFIGURATION

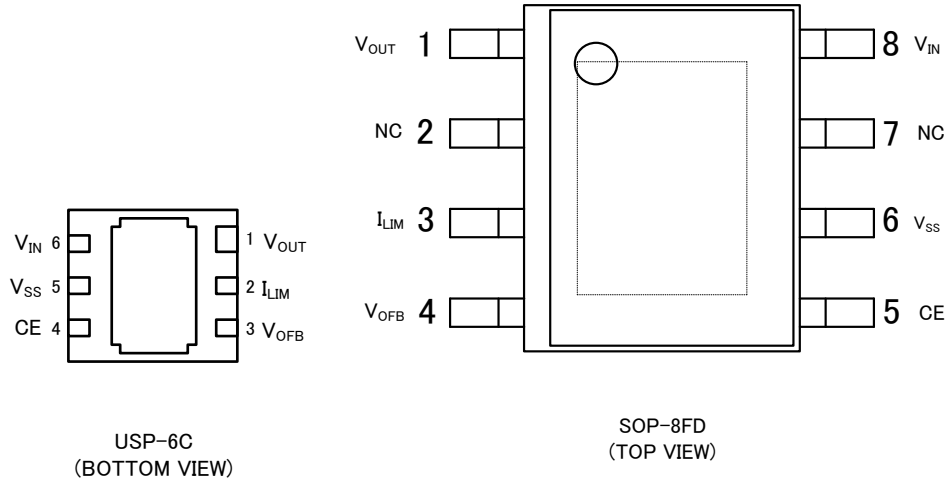

* The dissipation pad for the USP-6C package and the SOP-8FD package should be solder-plate to enhance mounting strength and heat release. Please see the reference mount pattern and metal masking.

If the pad needs to be connected to other pins, it should be connected to the V_{SS} (USP-6C: No. 5, SOP-8FD: No. 6) pin.

PIN ASSIGNMENT

PIN NUMBER		PIN NAME	FUNCTIONS
USP-6C	SOP-8FD		
1	1	V_{OUT}	Output
-	2, 7	NC	No Connection
2	3	I_{LIM}	Current Limit Adjustment
3	4	V_{OVB}	Output Voltage Adjustment
4	5	CE	ON/OFF Control
5	6	V_{SS}	Ground
6	8	V_{IN}	Power Input

PIN FUNCTIOS ASSIGNMENT

XC6230 Series

PIN NAME	SIGNAL	STATUS
CE	H	Active
	L	Stand-by
	OPEN	Stand-by*

* For CE pin voltage is fixed as L level because of internal pull-down resistor.

■ ABSOLUTE MAXIMUM RATINGS

PARAMETER		SYMBOL	RATINGS	UNITS
Input Voltage		V_{IN}	-0.3 ~ +7.0	V
Output Voltage		V_{OUT}	-0.3 ~ +7.0	V
CE Input Voltage		V_{CE}	-0.3 ~ +7.0	V
V_{OFB} Pin Voltage		V_{OFB}	-0.3 ~ +6.0	V
I_{LIM} Pin Voltage		V_{LIM}	-0.3 ~ +6.0	V
I_{LIM} Pin Current		I_{LIM}	±1.0	mA
Power Dissipation ($T_a=25^\circ\text{C}$)	USP-6C	Pd	1000 (40mm x 40mm Standard board) ^(*)	mW
			1250 (JESD51-7 board) ^(*)	
	SOP-8FD		1500 (40mm x 40mm Standard board) ^(*)	
			2500 (JESD51-7 board) ^(*)	
Operating Ambient Temperature		T_{opr}	-40 ~ +105	°C
Storage Temperature		T_{stg}	-55 ~ +125	°C

All voltage ratings are relative to V_{ss} .

^(*) This power dissipation figure shown is PCB mounted and is for reference only.
The mounting condition is please refer to PACKAGING INFORMATION.

ELECTRICAL CHARACTERISTICS

XC6230 series

Ta=25°C

PARAMETER	SYMBOL	CONDITIONS	MIN.	TYP.	MAX.	UNITS	CIRCUIT
Adjustable Output Voltage	V _{OFB}	-	1.188	1.200	1.212	V	①
Output Voltage Setting Range	V _{OUT_SET} ^(*)	-	1.2	-	5.0	V	①
Output Current	I _{OUTMAX}	-	2000	-	-	mA	①
Input Voltage	V _{IN}	-	1.7	-	6.0	V	①
Load Regulation1	ΔV _{OUT1}	0.1mA ≤ I _{OUT} ≤ 500mA	-	1	8	mV	①
Load Regulation2 ^(*)	ΔV _{OUT2}	0.1mA ≤ I _{OUT} ≤ 2000mA	-	1	14	mV	①
Dropout Voltage1 (Offset of Reverse Current Protection)	V _{dif1} ^(*)	R ₂₁ =33kΩ, R ₂₂ =11kΩ I _{OUT} =0mA	-	60	110	mV	①
Dropout Voltage2	V _{dif2} ^(*)	【USP-6C】 R ₂₁ =33kΩ, R ₂₂ =11kΩ I _{OUT} =1000mA	-	170	200	mV	①
		【SOP-8FD】 R ₂₁ =33kΩ, R ₂₂ =11kΩ I _{OUT} =1000mA	-	230	260	mV	①
Dropout Voltage3	V _{dif3} ^(*)	【USP-6C】 R ₂₁ =33kΩ, R ₂₂ =11kΩ I _{OUT} =2000mA	-	350	410	mV	①
		【SOP-8FD】 R ₂₁ =33kΩ, R ₂₂ =11kΩ I _{OUT} =2000mA	-	460	520	mV	①
Supply Current	I _{SS}	V _{IN} =6.0V, I _{OUT} =0mA	-	45	83	μA	②
Stand-by Current	I _{STBY}	V _{IN} =6.0V, V _{CE} =V _{SS}	-	0.01	0.10	μA	②
Line Regulation	ΔV _{OUT} / (ΔV _{IN} · V _{OUT})	1.7V ≤ V _{IN} ≤ 6.0V, I _{OUT} =100mA	-	0.05	0.10	%/V	①
Output Voltage Temperature Characteristics	ΔV _{OUT} / (ΔT _{opr} · V _{OUT})	-40°C ≤ T _{opr} ≤ 105°C	-	±100	-	ppm/°C	①
Power Supply Rejection Ratio	PSRR	V _{IN} =V _{CE} =2.2V+0.5Vp-p _{PAC} I _{OUT} =30mA, f=1kHz	-	70	-	dB	③

Unless otherwise stated,

V_{IN}=V_{CE}=V_{OUT}+1.0V, V_{OUT}=V_{OFB}, I_{OUT}=10mA, C_{IN}=2.2μF, C_L=4.7μF, R_{LIM}=0Ω

Parameter of electrical characteristics is applied when T_j ≅ 25°C become load conditions (pulse applied).

Unless ΔV_{OUT} / (ΔT_{opr} · V_{OUT}), T_{TSD} and T_{TSR} conditions.

NOTE:

^(*)V_{OUT_SET}: Nominal output voltage. V_{OUT_SET} is adjustable with external resistors (R₂₁, R₂₂). V_{OUT_SET} is 1.2V, If V_{OUT} = V_{OFB}.

⁽²⁾V_{dif}={V_{IN1}-V_{OUT1}}

V_{IN}: Gradually lower the input voltage, the input voltage when 3.3V is output.

V_{OUT}: V_{OUT_SET} is set to more than 3.3V, it is confirmed that the 3.3V is output to V_{OUT}.

⁽³⁾ Design reference value. This parameter is provided only for reference.

■ ELECTRICAL CHARACTERISTICS (Continued)

● XC6230 series

Ta=25°C

PARAMETER	SYMBOL	CONDITIONS	MIN.	TYP.	MAX.	UNITS	CIRCUIT
Limit Current	I _{LIM}	-	2250	2500	2750	mA	①
		R _{LIM} =200kΩ	240	300	370	mA	①
Short -Circuit Current	I _{SHORT}	V _{OUT} =V _{SS}	-	320	-	mA	①
		V _{OUT} =V _{SS} , R _{LIM} =200kΩ	-	180	-	mA	①
Input Impedance V _{OFB}	R _{VOFB}	V _{IN} =V _{CE} =6.0V, V _{OFB} =5.5V	0.7	1.7	2.7	MΩ	①
CE "H" Level Voltage	V _{CEH}	-	0.9	-	6.0	V	①
CE "L" Level Voltage	V _{CEL}	-	-	-	0.4	V	①
CE "H" Level Current	I _{CEH}	V _{IN} =6.0V, V _{CE} =6.0V	-	6.0	10.4	μA	①
CE "L" Level Current	I _{CEL}	V _{IN} =6.0V, V _{CE} =V _{SS}	-0.1	-	0.1	μA	①
Reverse Current	I _{REV} ⁽⁴⁾	V _{IN} =0V, V _{CE} =2.0V, V _{OUT} =6.0V	-	0.05	0.10	μA	①
V _{OUT} Sink Current at Reverse condition	I _{REVS} ⁽⁵⁾	V _{IN} =V _{CE} =5.0V, V _{OUT} =6.0V	-	0.9	1.6	μA	①
Inrush Current	I _{RUSH}	V _{IN} =6.0V, V _{CE} =0→6.0V	-	-	500	mA	①
Thermal Shutdown Detect Temperature	T _{TSD}	Junction Temperature	-	150	-	°C	①
Thermal Shutdown Release Temperature	T _{TSR}	Junction Temperature	-	125	-	°C	①
C _L Discharge Resistance (H Type)	R _{DCHG}	V _{IN} =6.0V, V _{CE} =V _{SS} , V _{OUT} =1.2V	-	35	-	Ω	①

Unless otherwise stated,

V_{IN}=V_{CE}=V_{OUT}+1.0V, V_{OUT}=V_{OFB}, I_{OUT}=10mA, C_{IN}=2.2μF, C_L=4.7μF, R_{LIM}=0Ω

Parameter of electrical characteristics is applied when T_j≒25°C become load conditions (pulse applied).

Unless ΔV_{OUT} / (ΔT_{opr} · V_{OUT}), T_{TSD} and T_{TSR} conditions.

NOTE:

⁽⁴⁾ reverse current (I_{REV}) shows the current flowing from the V_{OUT} terminal to V_{IN} terminal.

⁽⁵⁾ reverse flow during the V_{OUT} pin sink current (I_{REVS}) shows the current flowing from the V_{OUT} pin to the V_{SS} terminal.

TEST CIRCUITS

●Circuit①

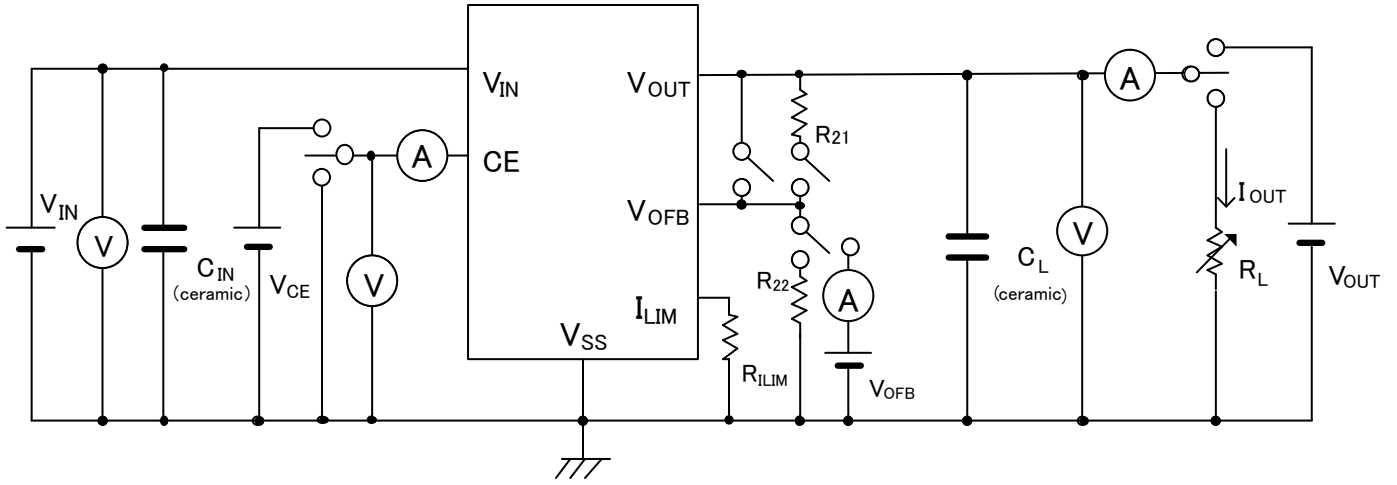

●Circuit②

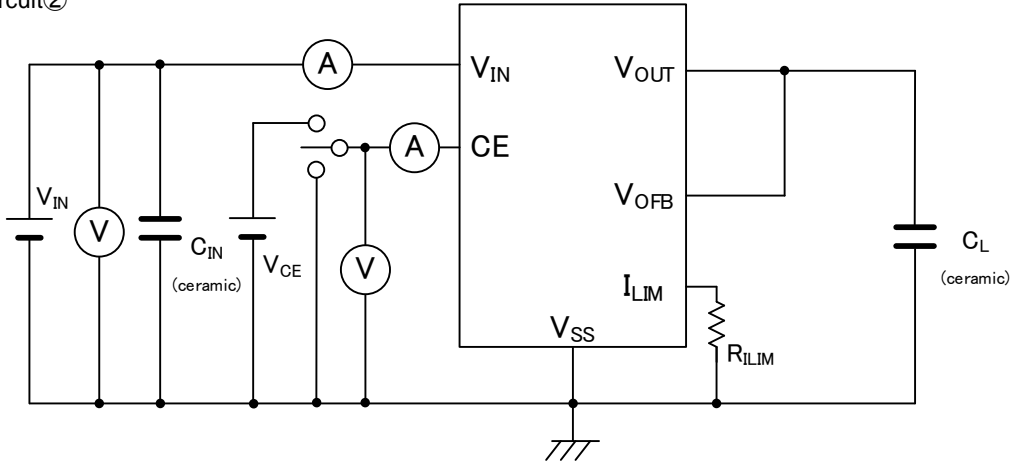

●Circuit③

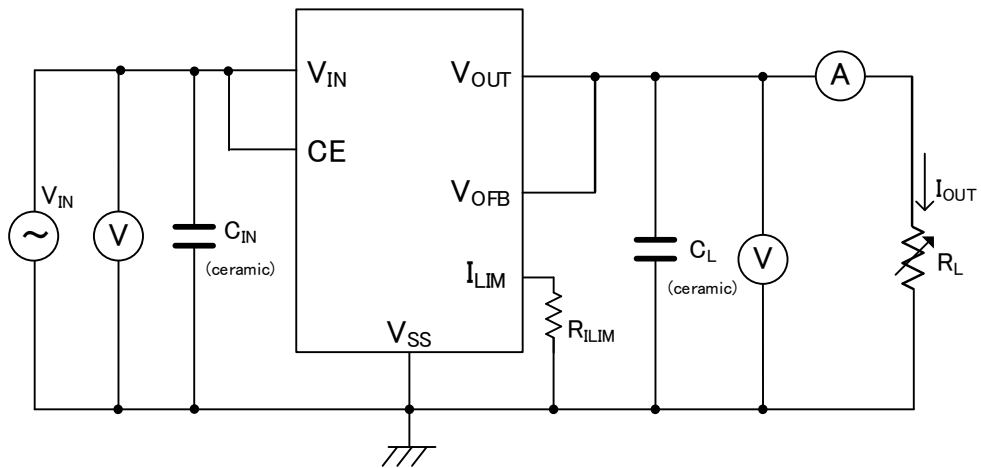

■ OPERATIONAL EXPLANATION

The XC6230 series controls the output voltage, divided by resistors R₁₁ & R₁₂ which are connected to the V_{OFB} pin is compared with the internal reference voltage by the error amplifier. The P-channel MOSFET connected to the V_{OUT} pin, is then driven by the subsequent output signal. The output voltage at the V_{OUT} pin is controlled & stabilized by negative feedback.

This IC the current limit circuit and short protect circuit operate in relation to the level of output current. The thermal protection operates in relation to the level of heat generation. The reverse current protection operates when V_{OUT} voltage is higher than V_{IN} voltage. Further, the IC's internal circuitry can be turned off via the CE pin's signal.

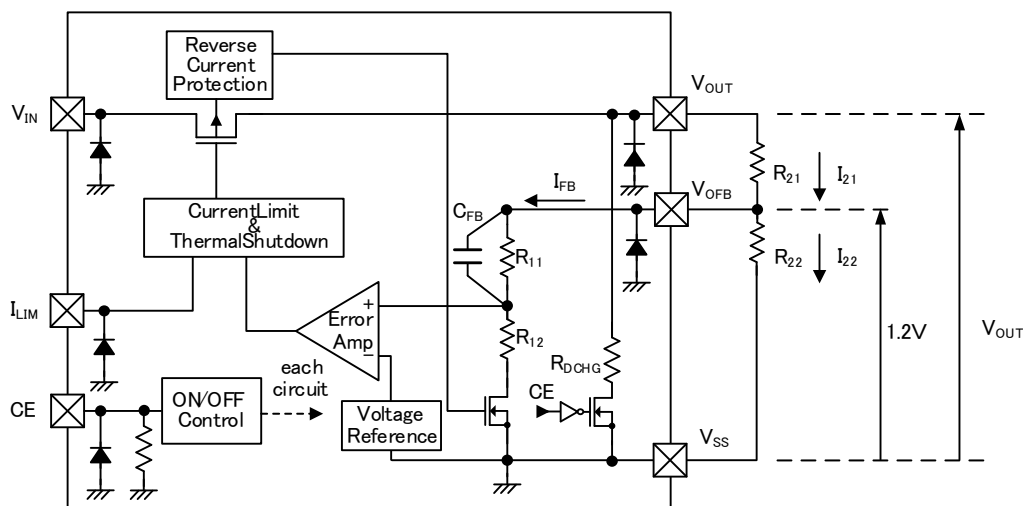

XC6230 Series, Type H.

<Output voltage outside the adjustable function>

XC6230series are possible to adjust the output voltage in the range of up to 1.2V ~ 5.0V by the value of the external resistor divider R₂₁ and R₂₂. The output voltage can be set externally by the following equation:

$$I_{21} = I_{FB} + I_{22} \dots\dots\dots (1)$$

$$I_{22} = V_{OFB}[V] / R_{22} \dots\dots\dots (2)$$

Following (1), (2) $I_{21} = I_{FB} + V_{OFB}[V] / R_{22} \dots\dots\dots (3)$

Setting output voltage "V_{OUT_SET}" is the sum of the voltage which is determined by the current flowing through the V_{OFB} voltage and resistance R₂₁.

$$V_{OUT_SET} = V_{OFB}[V] + R_{21} \times I_{21} \dots\dots\dots (4)$$

Substituting (3) in (4), $V_{OUT_SET} = V_{OFB}[V] + R_{21} \times (I_{FB} + V_{OFB}[V] / R_{22})$
 $= V_{OFB}[V] \times (R_{21} + R_{22}) / R_{22} + R_{21} \times I_{FB} \dots\dots\dots (5)$

Following (5), can decide arbitrary setting voltage.

In this case, it becomes V_{OFB} [V] = 1.200V (TYP.) from the electrical characteristics.

The second term of the equation (5), R₂₁ × I_{FB}, is the cause of the output voltage precision error.

The I_{FB} can be calculated by the following equation;

$$I_{FB} = V_{OFB}[V] / (R_{11} + R_{12}) \text{ (*1)} \dots\dots\dots (6)$$

(*1): (R₁₁ + R₁₂) = R_{V_{OFB}} (Electrical characteristics R_{V_{OFB}} reference.)

The cause of the output precision error, R₂₁ × I_{FB} can be calculated by the equation below;

$$R_{21} \times I_{FB} = R_{21} \times V_{OFB}[V] / R_{V_{OFB}}$$

$$= V_{OFB}[V] \times R_{21} / R_{V_{OFB}} \dots\dots\dots (7)$$

Accordingly, if R₂₁ ≪ R_{V_{OFB}}, Precision error of the output voltage setting, it can be made very small.

However, customers please would be selected on that was evaluated by your conditions of use. If the external resistance value is small, there is a trade-off between current consumption increases. The value of R₂₂ is recommended TYP=47kΩ.

Please use by connecting the V_{OUT} pin and V_{OFB} terminal, when used as 1.2V set up.

OPERATIONAL EXPLANATION (Continued)

<XC6230 series setting resistor dependence of output voltage>

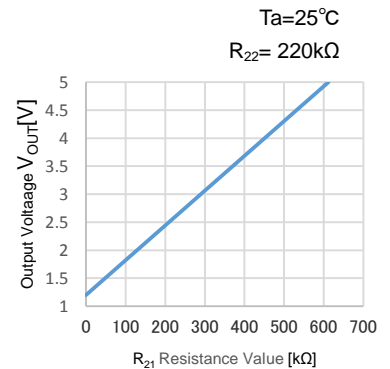
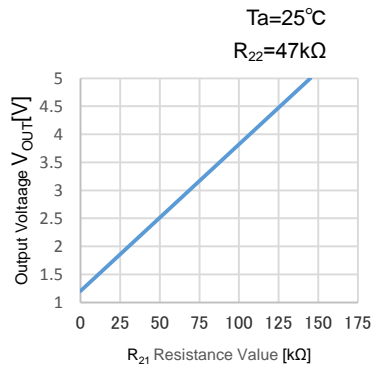
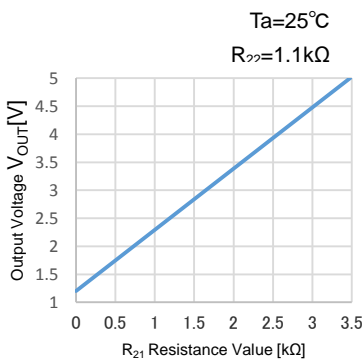

<XC6230 series Temperature characteristics of the output voltage>

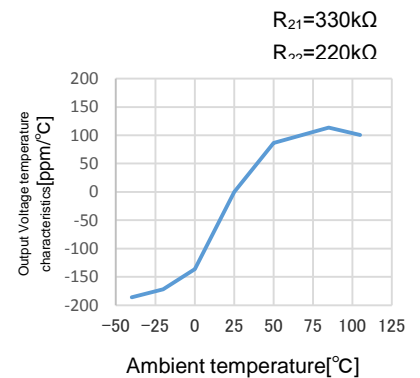
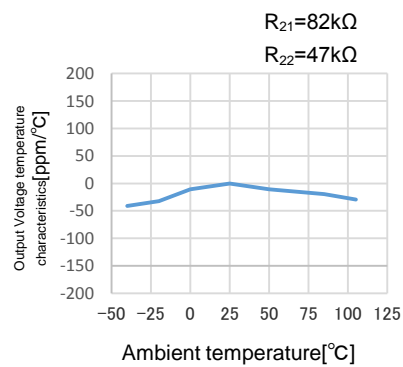
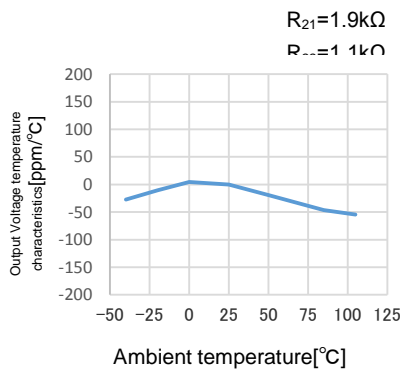

Large external feedback resistor (R₂₁, R₂₂) can no longer be ignored I_{FB} flowing into the IC, they will affect the set output voltage and the output voltage temperature characteristics.

Therefore, the feedback resistor should be chosen to be the R₂₂ ≤ 220kΩ.

<Low ESR Capacitors>

The XC6230 series needs an output capacitor (C_L) for phase compensation. In order to ensure the stable phase compensation, please place an output capacitor (C_L) of 4.7μF or bigger at the V_{OUT} pin and V_{SS} pin as close as possible. For a stable power input, please connect an input capacitor (C_{IN}) of 2.2μF between the input pin (V_{IN}) and the ground pin (V_{SS}).

Since Input capacitor (C_{IN}), the output capacitor (C_L) are bias dependence of the capacitor the influence of the missing capacity due to temperature characteristics, also there is a risk that cannot be stable phase compensation under the influence of the ESR. Please pay attention to the selection of the capacitor to be used.

■ OPERATIONAL EXPLANATION (Continued)

<Current Limiter, Short-Circuit Protection>

The protection circuit operates as a combination of an output current limiter and fold-back short circuit protection. When load current reaches the current limit level, the output voltage drops. As a result, the load current starts to reduce with showing fold-back curve. The output current finally falls at the level of 320mA (TYP.) when the output pin (V_{OUT}) is short-circuited (R_{LIM}=0Ω).

<Current limit external adjustment function>

By connecting a resistor to the current limit external adjustment pin (I_{LIM}), the current limit can be set to any value. By the following each equations, the current limit value can be set to any value within a range of 300mA to 2500mA (TYP.).

Initial value of the current limit is set to 2500mA (TYP.) on IC inside. Please be sure to use the current limit external control terminal (I_{LIM}) are connected by either 0Ω short to V_{SS} terminal on the substrate.

When the I_{LIM} pin is open, the switch transistor is forcibly turned off.

$$\text{In case of } 300\text{mA} \leq I_{LIM(T)} \leq 500\text{mA range, } R_{LIM}[\text{k}\Omega] = 74300 / I_{LIM(T)}[\text{mA}] - 48.2[\text{k}\Omega] \dots\dots\dots(8)$$

$$\text{In case of } 500\text{mA} < I_{LIM(T)} \leq 1500\text{mA range, } R_{LIM}[\text{k}\Omega] = 65200 / I_{LIM(T)}[\text{mA}] - 30.0[\text{k}\Omega] \dots\dots\dots(9)$$

$$\text{In case of } 1500\text{mA} < I_{LIM(T)} < 2500\text{mA range, } R_{LIM}[\text{k}\Omega] = 49800 / I_{LIM(T)}[\text{mA}] - 19.9[\text{k}\Omega] \dots\dots\dots(10)$$

R_{LIM}: The external resistance value, I_{LIM(T)}: The current limit value

Table 1. Current Limit Setting List

I _{LIM(T)} [mA]	R _{LIM} [kΩ]	(E96) Resistor [kΩ]	Current Limit [mA] (TYP.)	I _{LIM(T)} [mA]	R _{LIM} [kΩ]	(E96) Resistor [kΩ]	Current Limit [mA] (TYP.)
300	199.5	200	299	1500	13.5	13.3	1506
400	137.6	137	401	1600	11.2	11.3	1596
500	100.4	100	501	1700	9.4	9.31	1705
600	78.7	78.7	600	1800	7.8	7.87	1793
700	63.1	63.4	698	1900	6.3	6.34	1898
800	51.5	51.1	804	2000	5.0	4.99	2001
900	42.4	42.2	903	2100	3.8	3.83	2099
1000	35.2	34.8	1006	2200	2.7	2.67	2206
1100	29.3	29.4	1098	2300	1.8	1.78	2297
1200	24.3	24.3	1201	2400	0.9	0.909	2393
1300	20.2	20	1304	2500	I _{LIM} shorted to V _{SS}		2500
1400	16.6	16.5	1402				

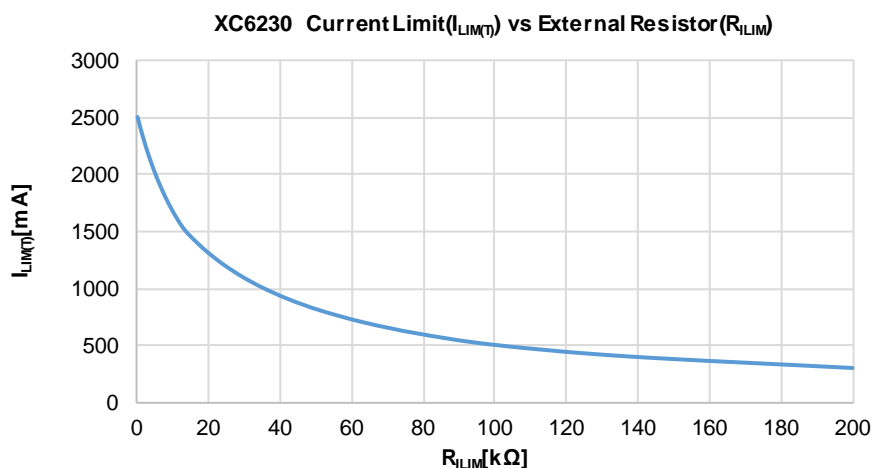

■ OPERATIONAL EXPLANATION (Continued)

<Thermal Shutdown>

When the junction temperature of the built-in driver transistor reaches the temperature limit, the thermal shutdown circuit operates and the driver transistor will be set to OFF. The IC resumes its operation when the thermal shutdown function is released and the IC's operation is automatically restored because the junction temperature drops to the level of the thermal shutdown release voltage.

<CE Pin>

The IC's internal circuitry can be shutdown via the signal from the CE pin.
H type has a pull-down resistor at the CE pin inside IC, so that the CE pin input current flows.

<Inrush Current Protection>

The inrush current protection circuit is built in the IC.
When the IC starts to operate, the protection circuit limits the inrush current within 500mA (MAX.) from input pin (V_{IN}) to output pin (V_{OUT}) to charge C_L capacitor. However the control of the internal IC cannot be supply more than 500mA (MAX.) for about 300 μ s.

<Reverse Current Protection>

The XC6230 series includes reverse current protection to prevent the damage battery or the like which is connected to the V_{IN} pin to prevent the destruction as a result of backflow from V_{OUT} pin to the V_{IN} pin and V_{SS} pin when the power supply is connected to the V_{OUT} pin. When V_{IN} is smaller than V_{OUT} , the reverse current protection works and suppress the reverse current to 0.1 μ A (MAX.). When V_{IN} is smaller than V_{OUT} , the V_{OUT} pin sink current I_{REVS} flowing from the V_{OUT} pin to the V_{SS} pin is 0.9 μ A (TYP.) as the IC operation current.

<CL Auto-Discharge Function>

The XC6230 H type contains a C_L auto-discharge resistor and an N-channel transistor between the V_{OUT} pin and the V_{SS} pin. The device quickly discharge the electric charge in the output capacitor (C_L) when a low signal to the CE pin is input to turn off a whole IC circuit. The C_L auto-discharge resistance is set at 35 Ω ($V_{OUT}=1.2V$ TYP. @ $V_{IN}=6.0$). Discharge time of the output capacitor (C_L) is determined by a C_L auto-discharge resistor value (R_{DCHG}) and an output capacitor value. Time constant τ is defined as ($\tau = C_L \times R_{DCHG}$). Output voltage after starting discharge can be calculated by the following formula.

$$V = V_{OUT(E)} \times e^{-t/\tau} \dots\dots\dots(11)$$

V : Output voltage after starting discharge
 $V_{OUT(E)}$: Output voltage
 t : Discharge time
 τ : $R_{DCHG} \times C_L$
 C_L : Capacitance connected V_{OUT} pin
 R_{DCHG} : Output discharge resistor (C_L Discharge Resistance)

It can be expanded on "t",
it is possible to obtain the discharge time from the above equation.

$$t = \tau \ln(V_{OUT(E)} / V) \dots\dots\dots(12)$$

■ NOTES ON USE

- For temporary, transitional voltage drop or voltage rising phenomenon, the IC is liable to malfunction should the ratings be exceeded.
- Where wiring impedance is high, operations may become unstable due to the noise and/or phase lag depending on output current. Please strengthen V_{IN} and V_{SS} wiring in particular.
- The input capacitor (C_{IN}) and the output capacitor (C_L) should be placed to the as close as possible with a shorter wiring.
- This IC has output stabilized by negative feedback control so as to follow the output fluctuation.
The negative feedback control because the response delay exists, for a change of steep load current, to compensate for the supply of the load current by the discharge of charge from the output capacitor (C_L).
However, since the electric charge discharge voltage temporarily drops, please use as large as possible a stabilization capacitance value of output capacitor (C_L) you have our check the electrical characteristics If that can occur sudden input change and load change on the application.
- Torex recommend that the resistance tolerance and temperature coefficient of resistance (T.C.R) is selected the small parts in use, since the characteristics of the external resistor will affect the output voltage and current limit.
- If you are setting the current limit with an external resistor, Please set the maximum output current, which is to use it as equal to or less than about 80% of the current limit setting value ($I_{LIM(T)}$).
- In the case that high resistors value of the R_{21}, R_{22} are used for the XC6230S001 version and a voltage close to the input voltage level is applied to the output voltage Pin in the condition of CE="L", the output voltage may be maintained near the input voltage level.
If it is necessary to reduce the output voltage to 0 V under these conditions, please adjust the resistance of R_{21} and R_{22} and connect a load resistance so that a load current of 30uA or more can flow to the output side.
- Please use in the $V_{IN}-V_{OUT}$ difference and load current, in the range of heat loss does not exceed the allowable loss.
For a change in the heat dissipation properties also by the substrate conditions, please design or select a good substrate of the heat dissipation efficiency.
- When adding a large capacitance or an electric double layer capacitor to the output line, overcurrent can flow momentarily at the current limit changing point in the low output voltage range.
To prevent overcurrent, please use an output capacitor of 120 μF or less. In addition, when using this IC to charge an electric double layer capacitor and the like, please put a resistor between an output capacitor (C_L) and an electric double layer capacitor to prevent inrush current so that excessive overcurrent does not flow.

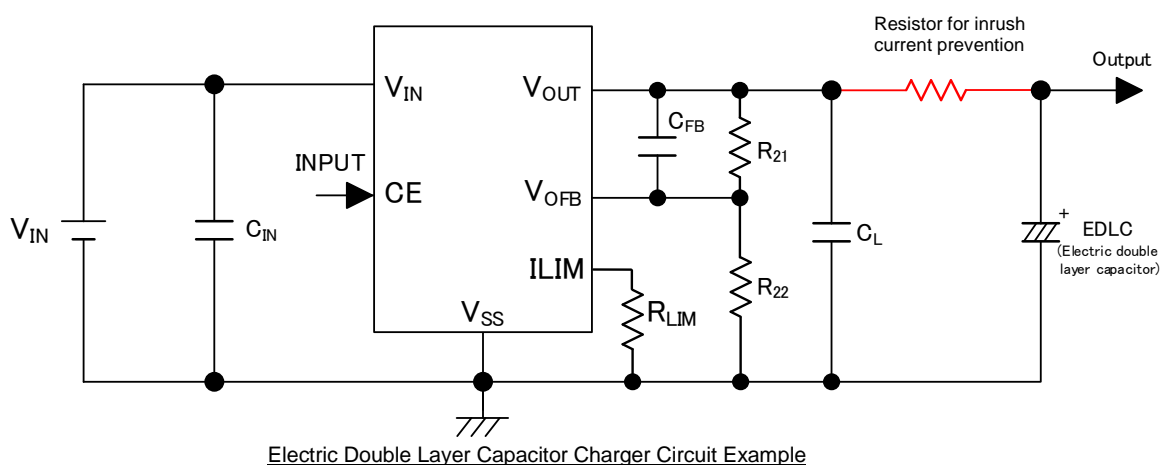

- Torex places an importance on improving our products and its reliability. However, by any possibility, we would request user fail-safe design and post-aging treatment on system or equipment.

TYPICAL PERFORMANCE CHARACTERISTICS

(1) Output Voltage vs. Output Current

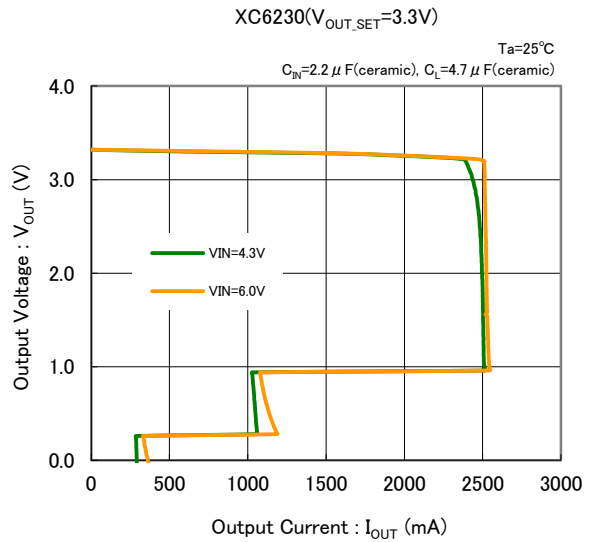
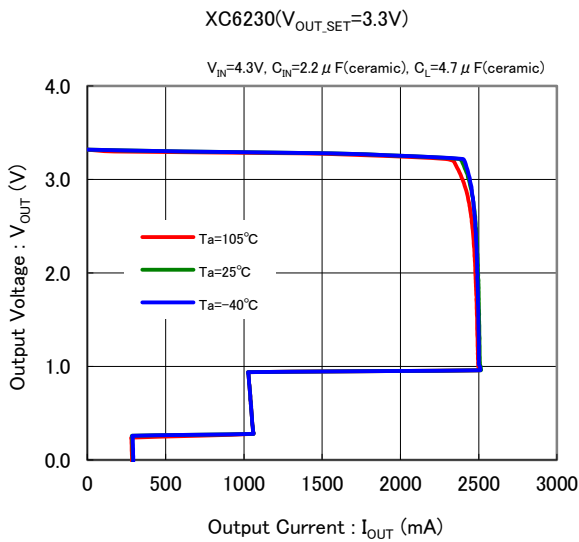
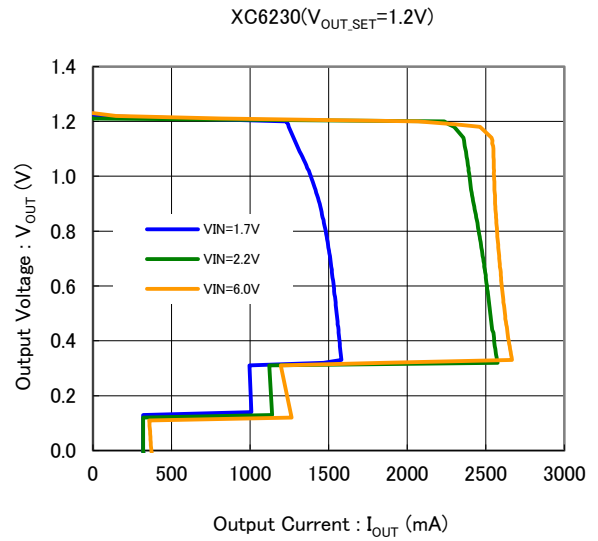
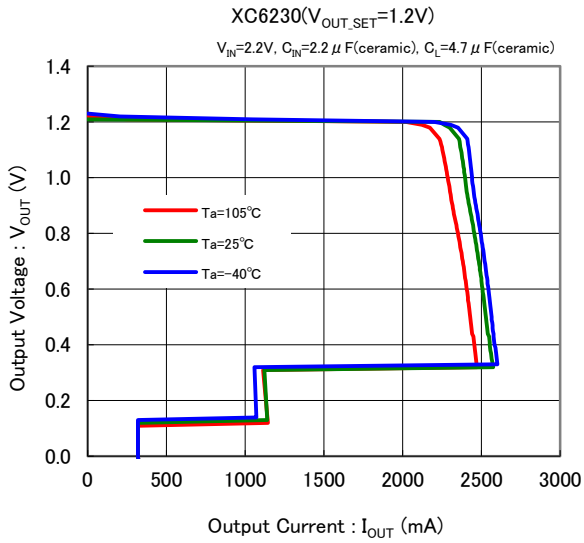

(2) Output Voltage vs. Output Current (Output current externally adjusted.)

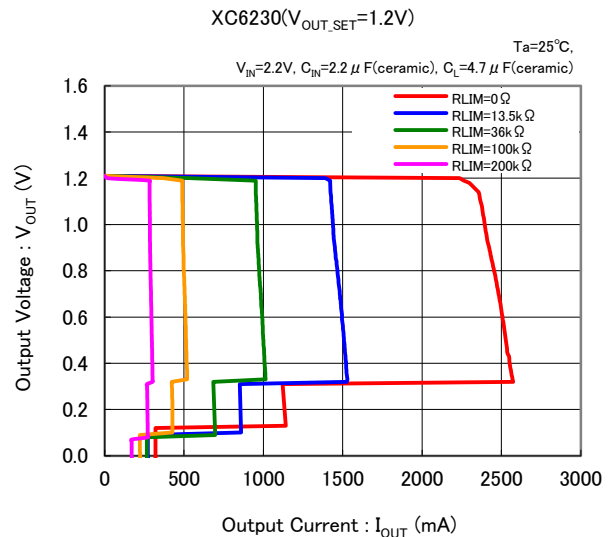
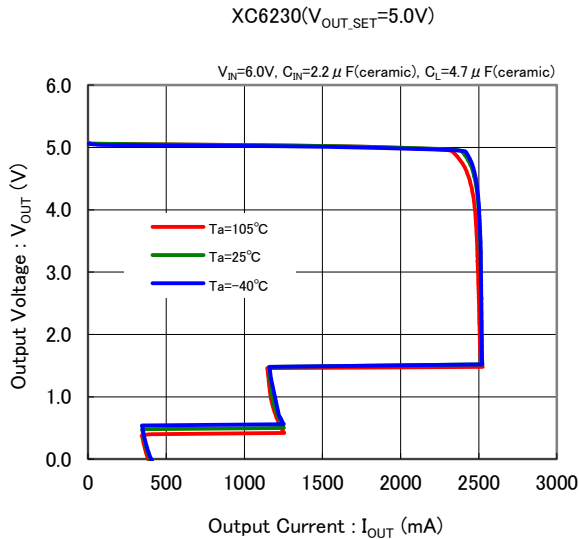

■ TYPICAL PERFORMANCE CHARACTERISTICS (Continued)

(3) Output Voltage vs. Input Voltage

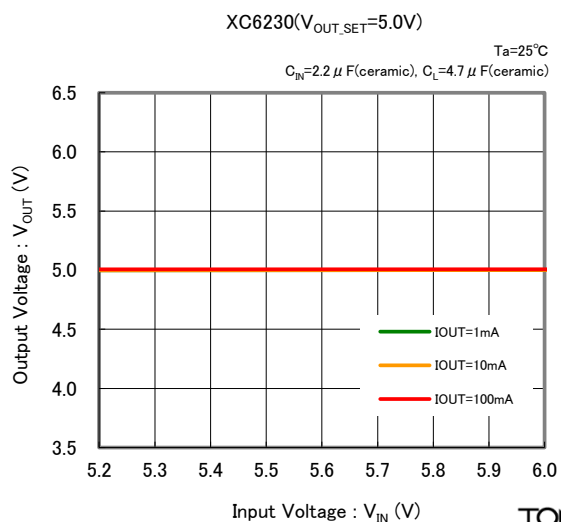
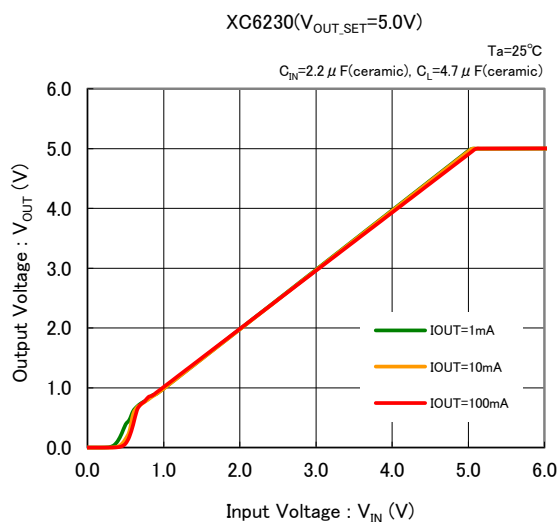
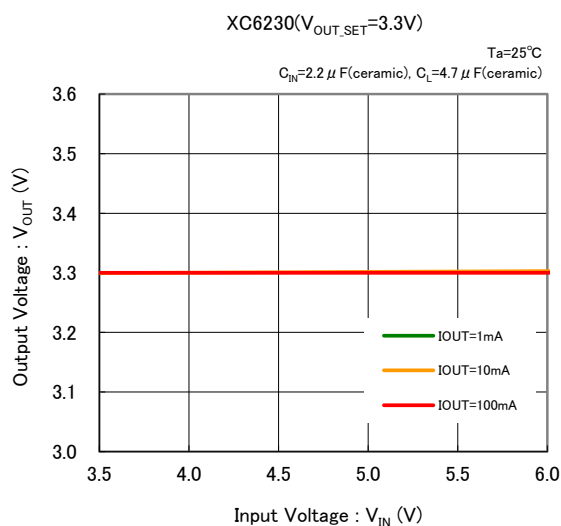
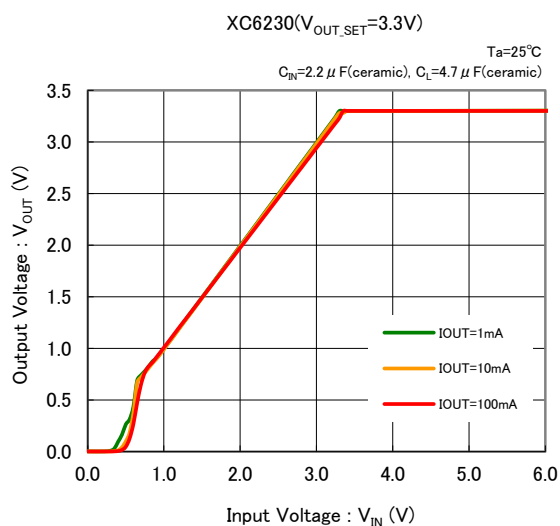
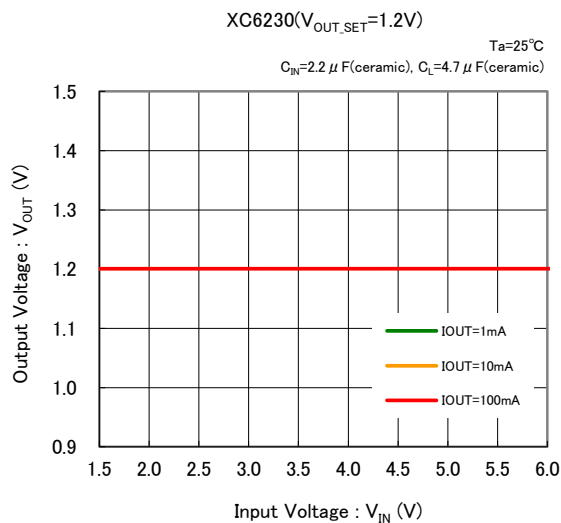
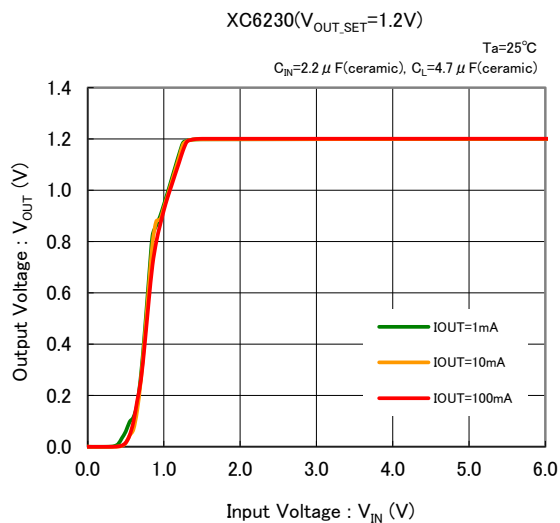

TYPICAL PERFORMANCE CHARACTERISTICS (Continued)

(4) Dropout Voltage vs. Output Current

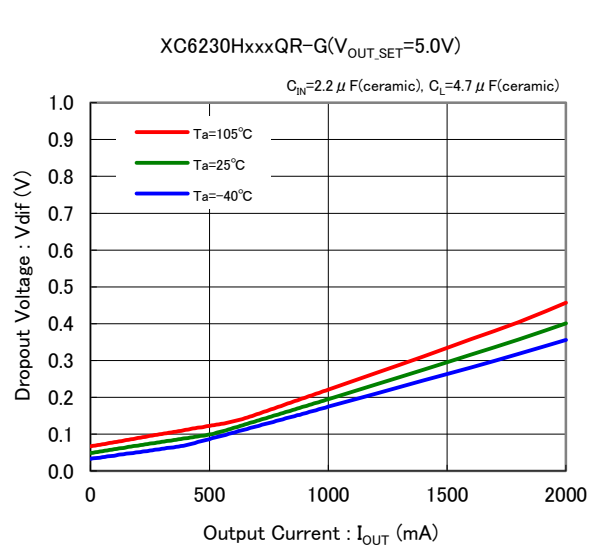
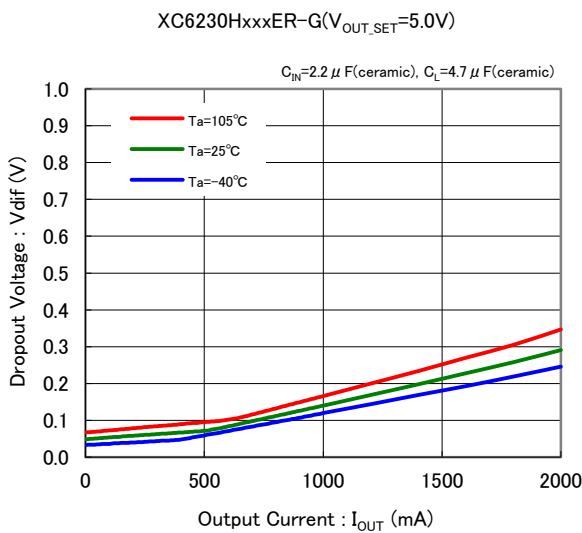
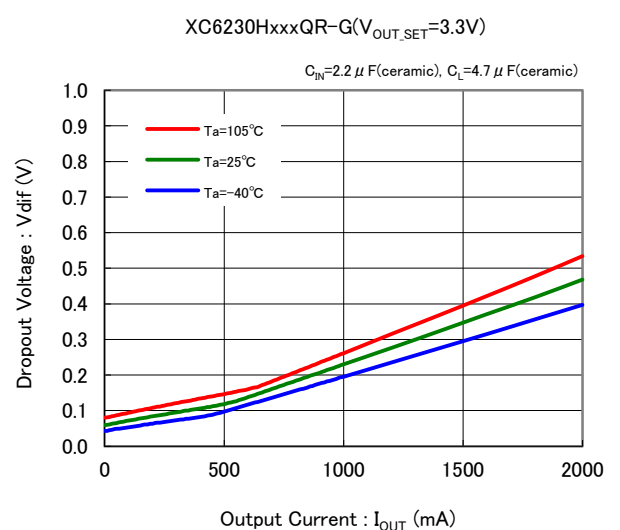
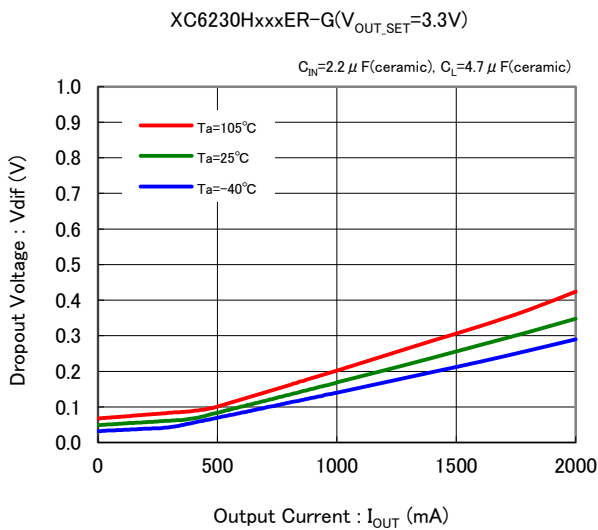
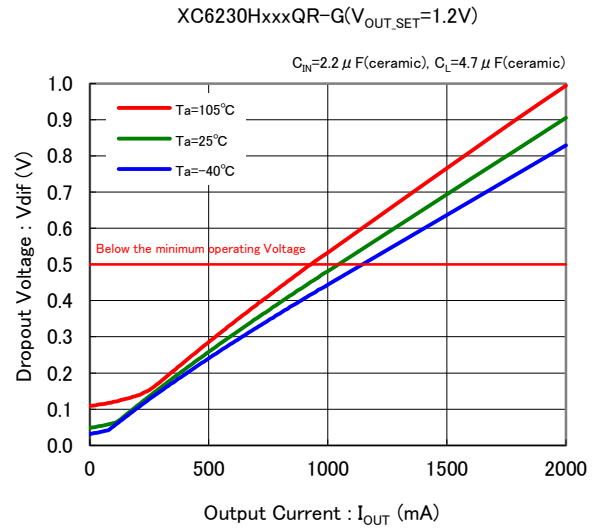
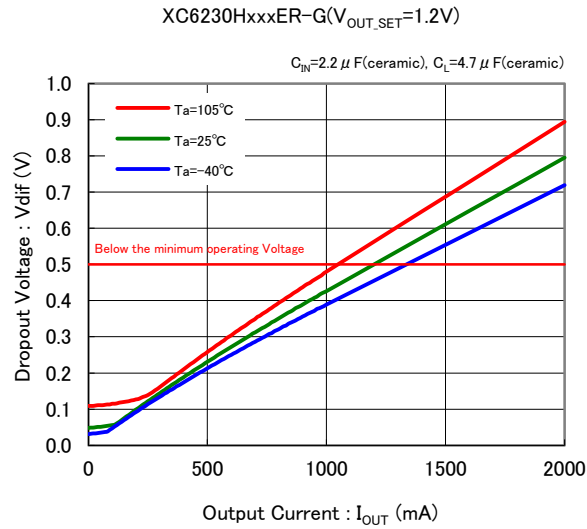

TYPICAL PERFORMANCE CHARACTERISTICS (Continued)

(5) Supply Current vs. Input Voltage

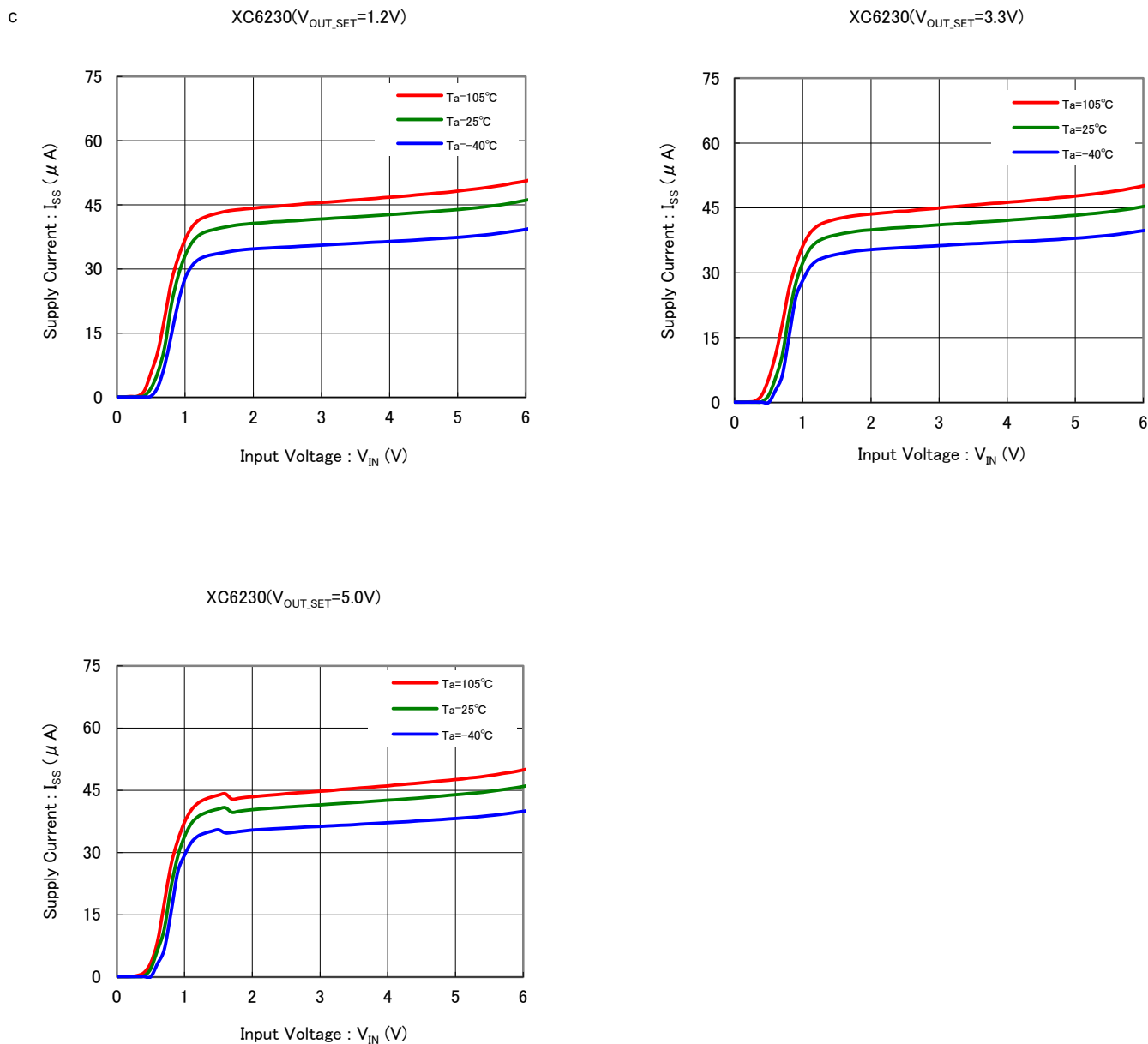

(6) Supply Current vs. Ambient Temperature

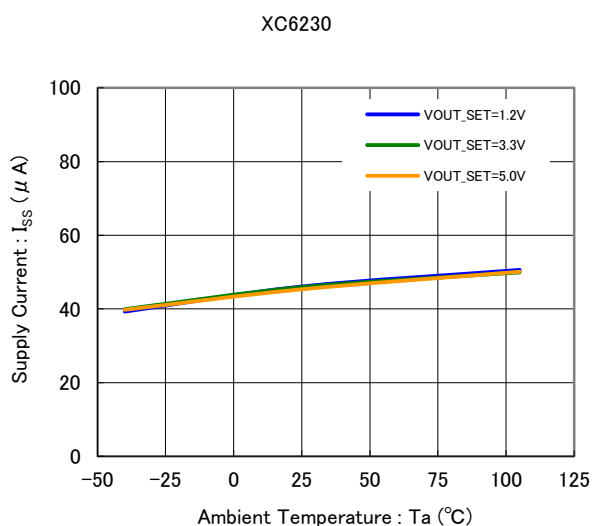

(7) Output Voltage vs. Ambient Temperature

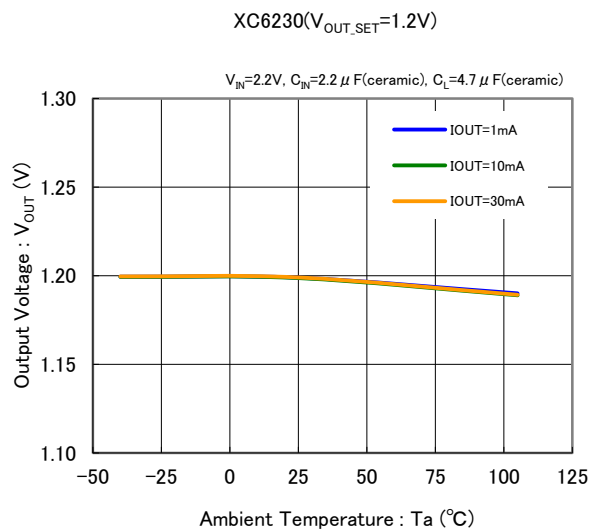

TYPICAL PERFORMANCE CHARACTERISTICS (Continued)

(7) Output Voltage vs. Ambient Temperature

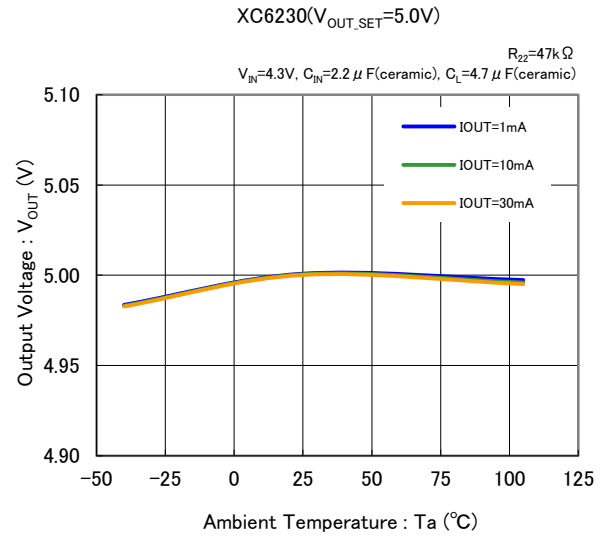
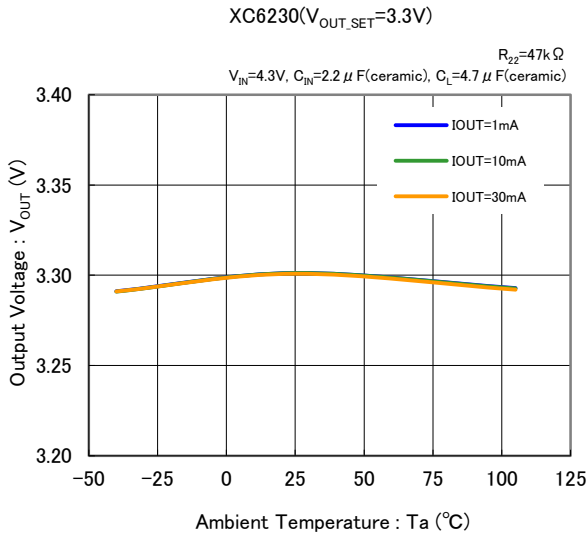

(8) CE Threshold Voltage vs. Ambient Temperature

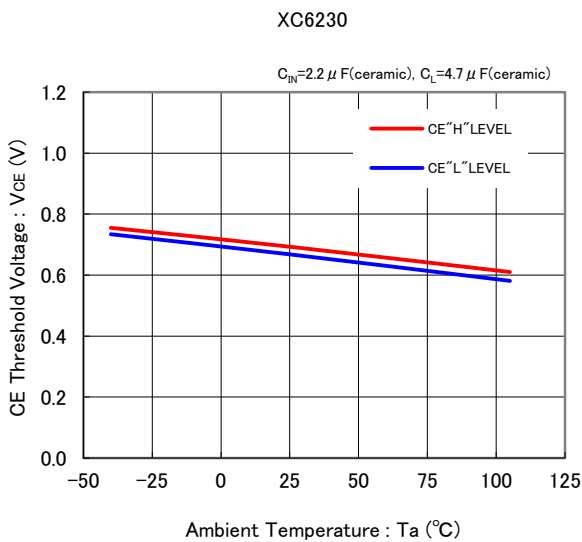

(9) Reverse Current vs. Output Voltage

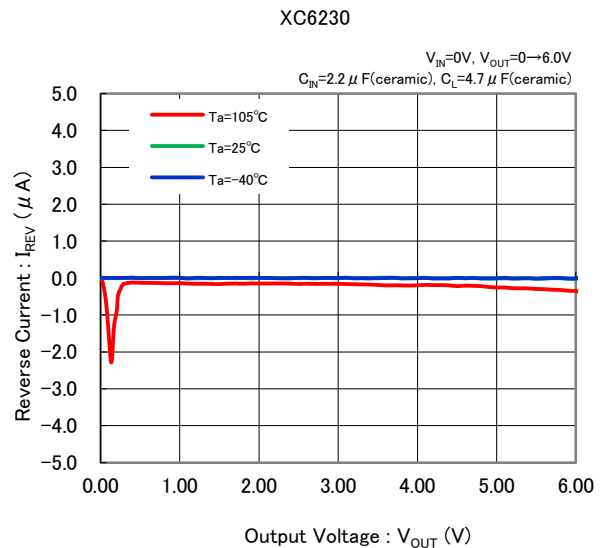

(10) V_{OUT} Sink Current vs. Input Voltage

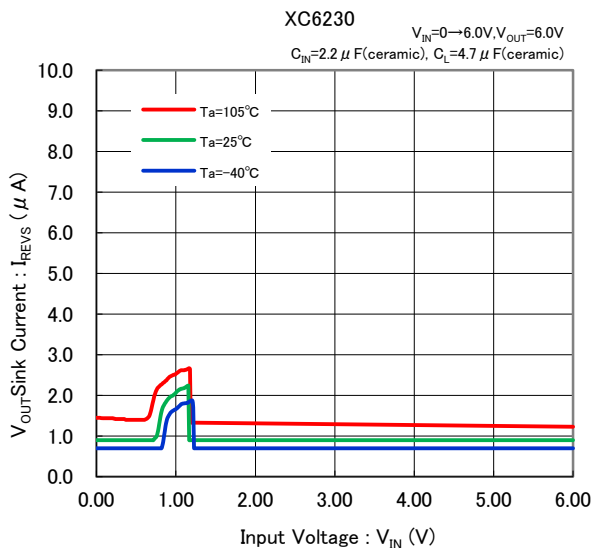

(11) Rising Response Time

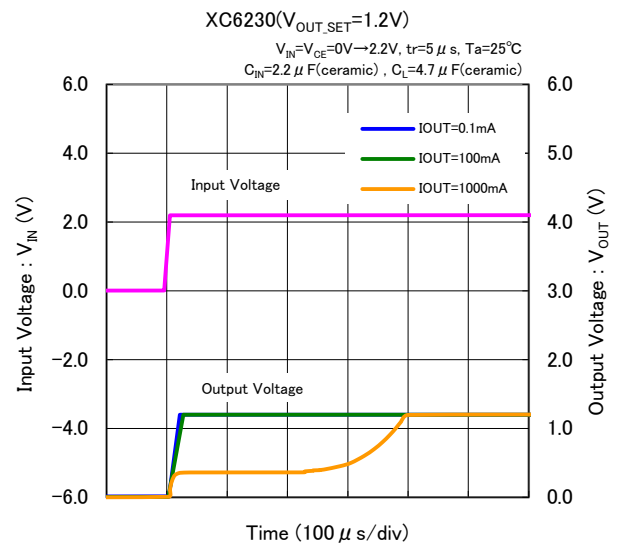

TYPICAL PERFORMANCE CHARACTERISTICS (Continued)

(11) Rising Response Time

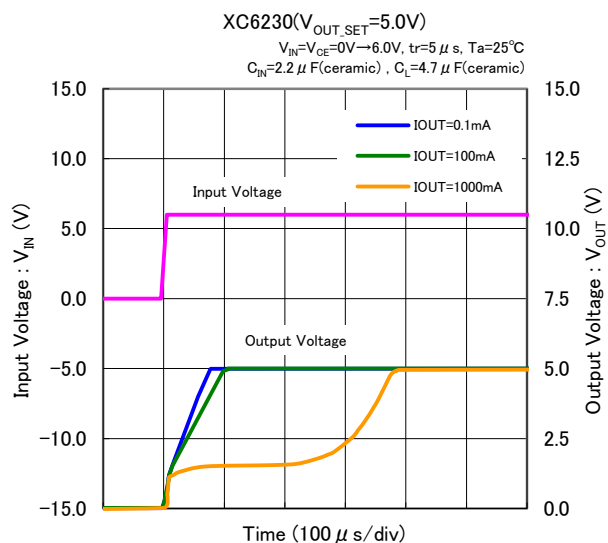
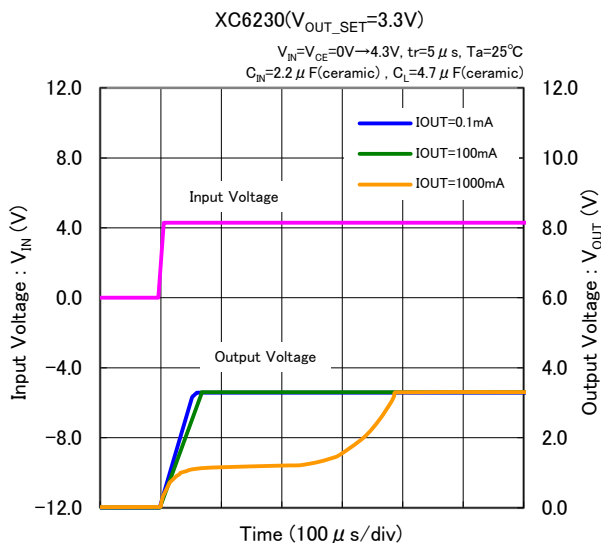

(12) Input Transient Response

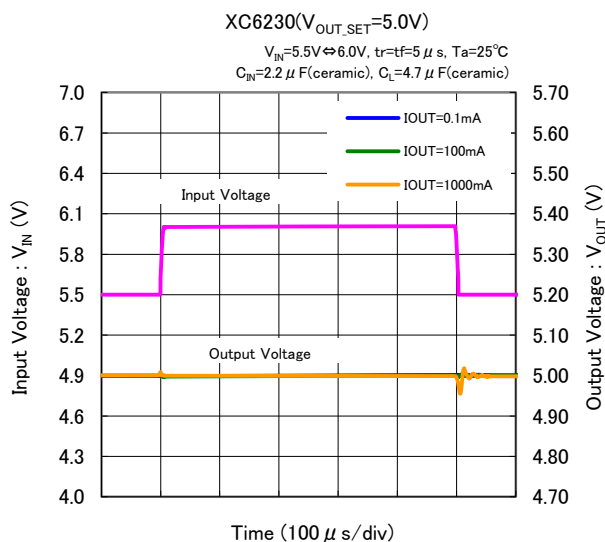
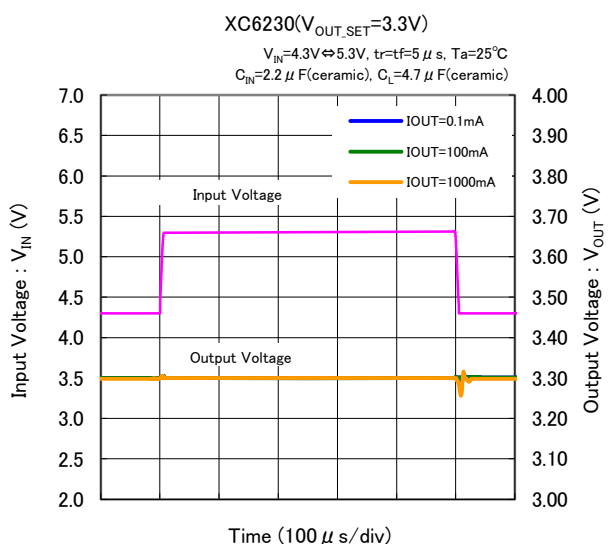
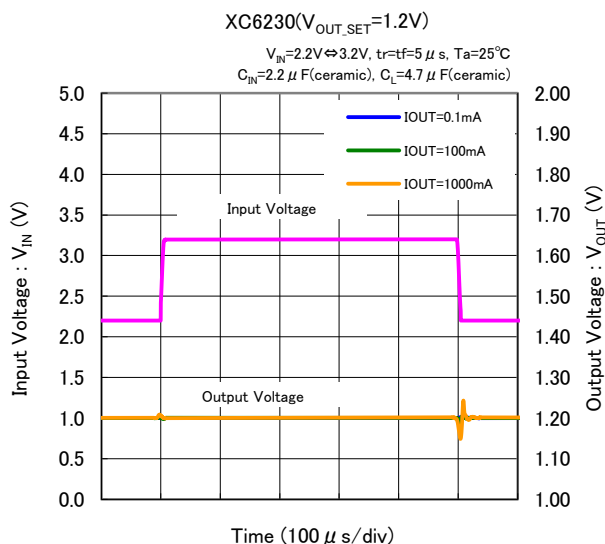

TYPICAL PERFORMANCE CHARACTERISTICS (Continued)

(13) Load Transient Response

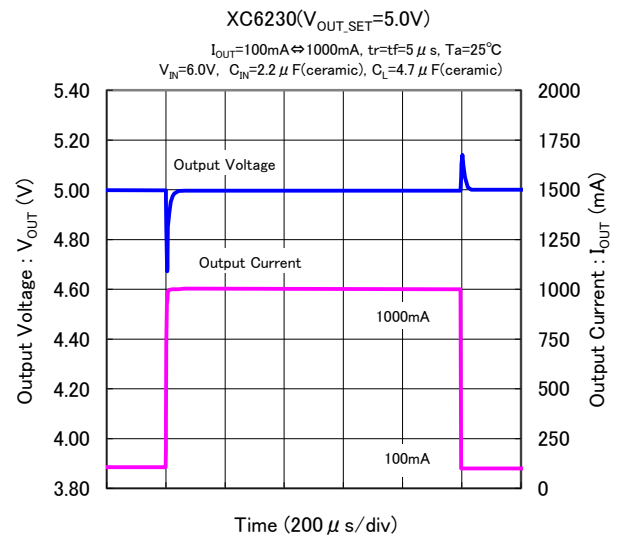
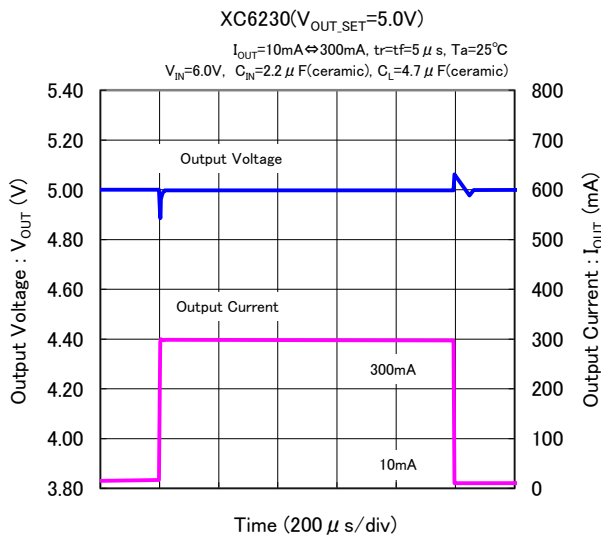
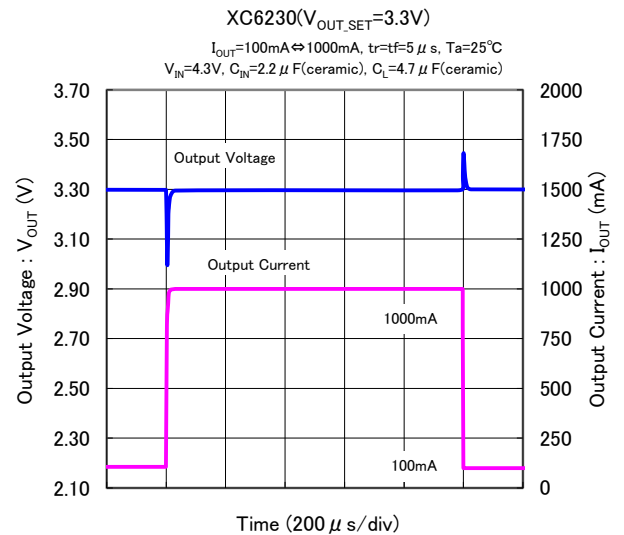
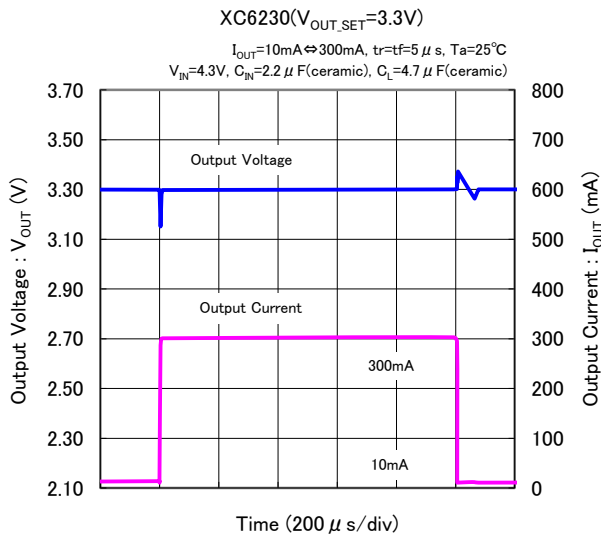
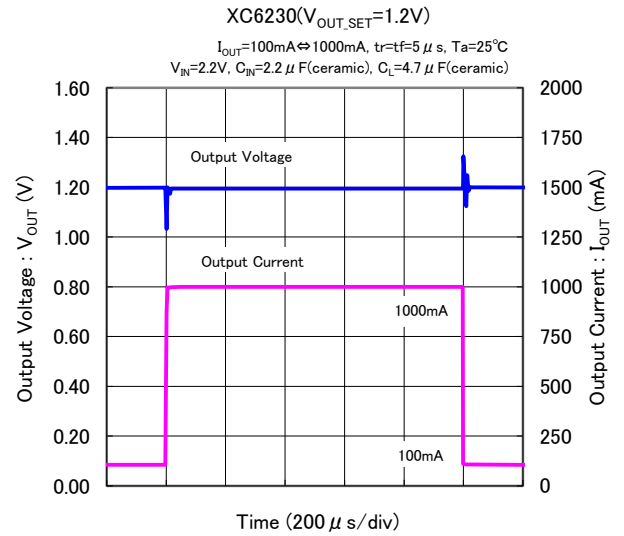
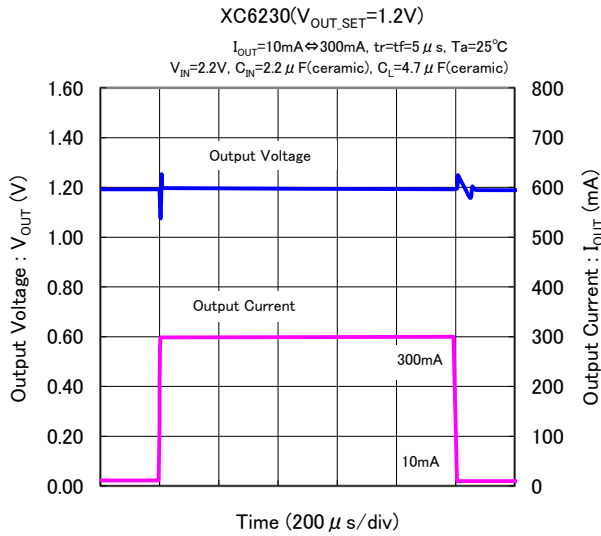

TYPICAL PERFORMANCE CHARACTERISTICS (Continued)

(14) CE Rising Response Time

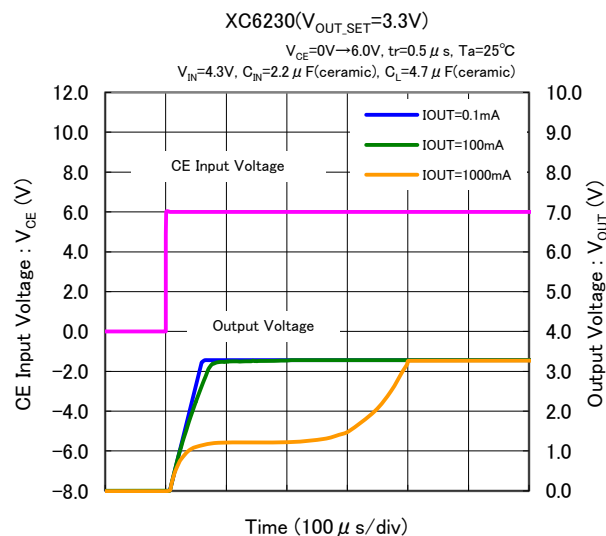
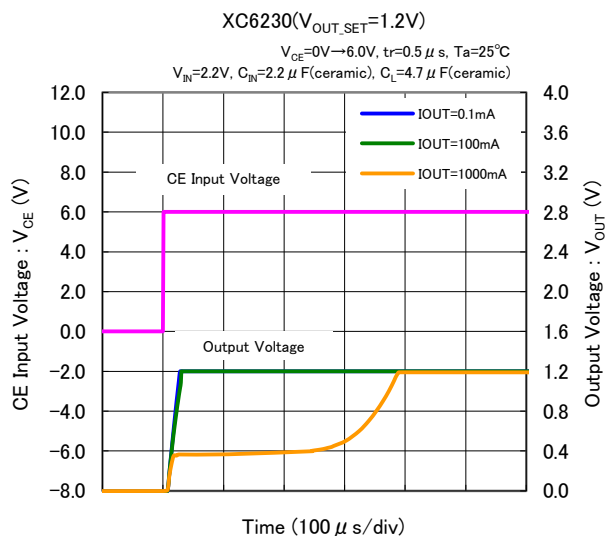

(15) Inrush Current Response

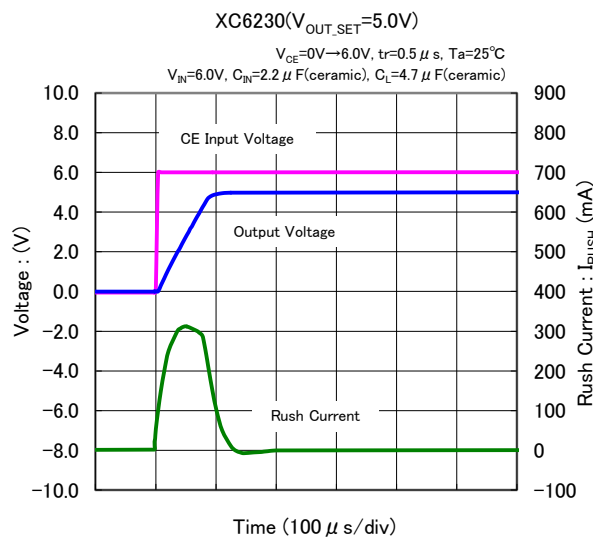
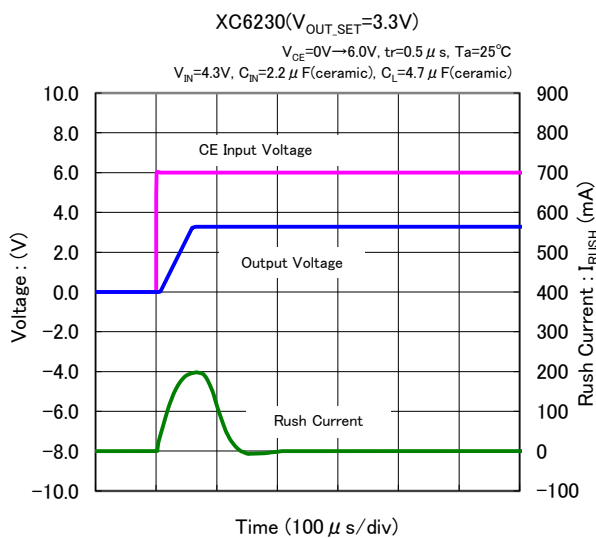
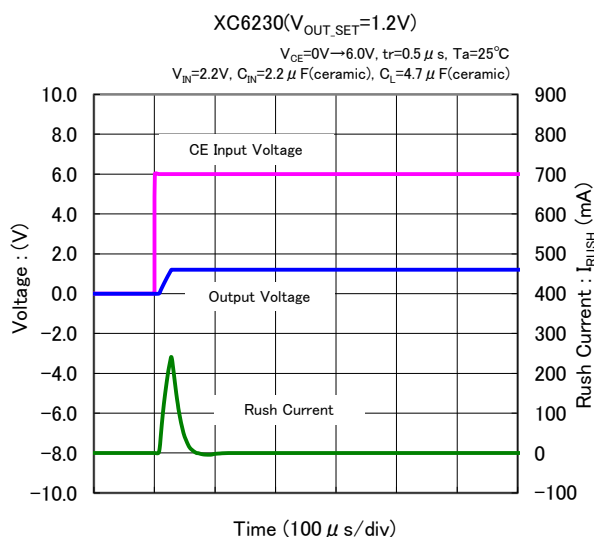
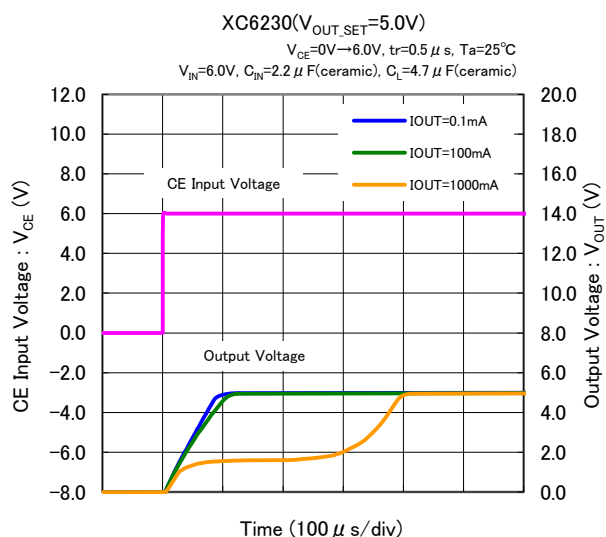

TYPICAL PERFORMANCE CHARACTERISTICS (Continued)

(16) Power Supply Rejection Ratio

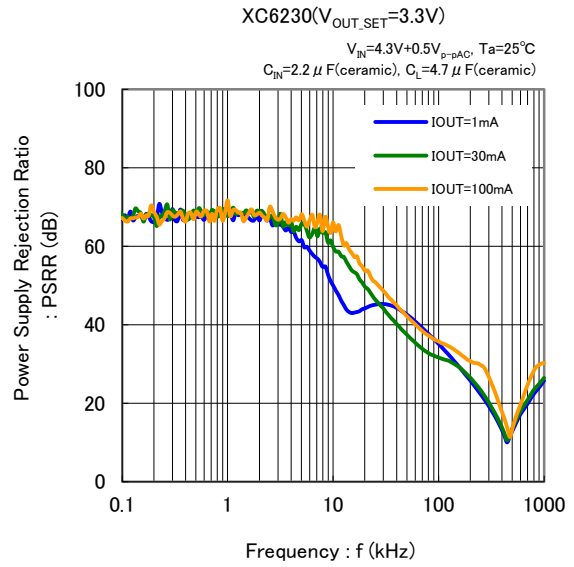
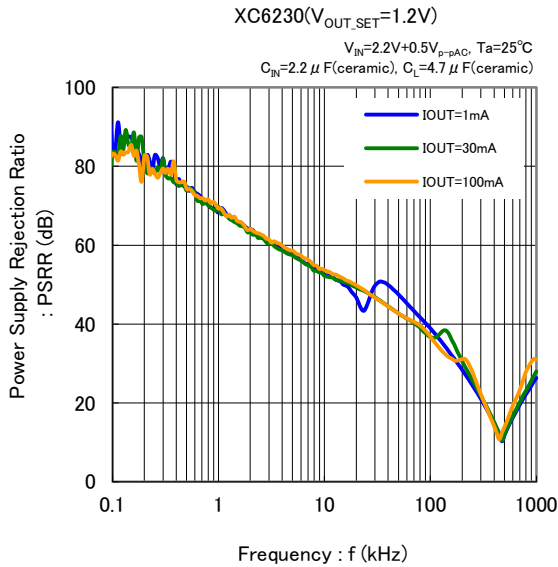

(17) Output Noise Density

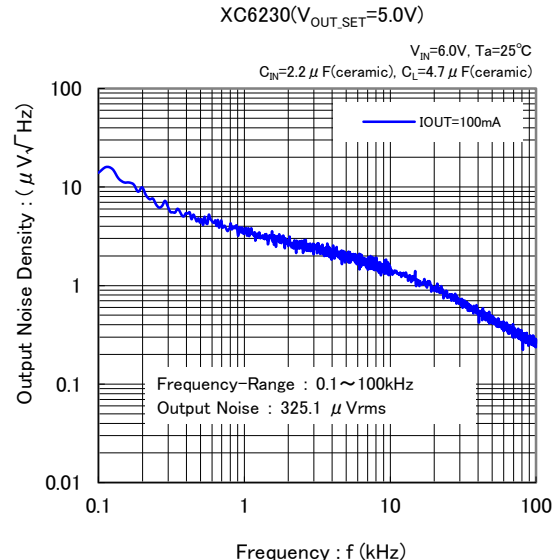
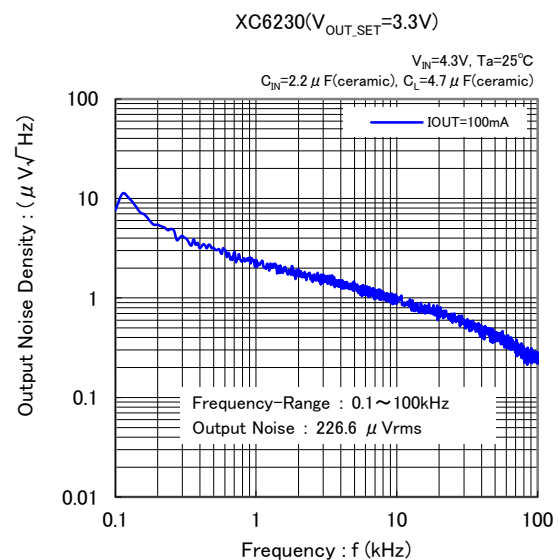
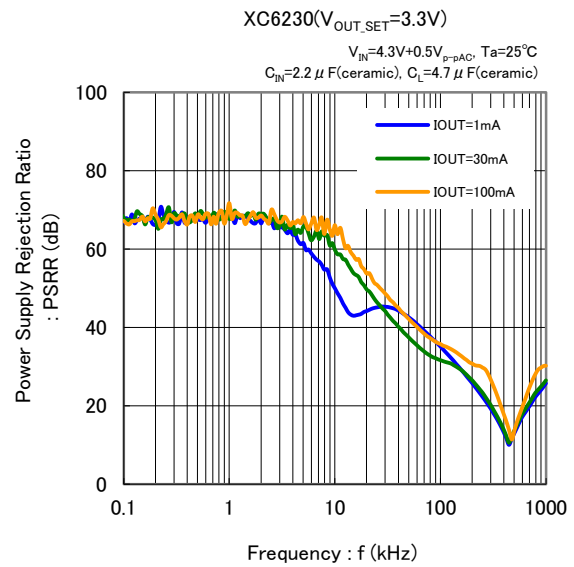
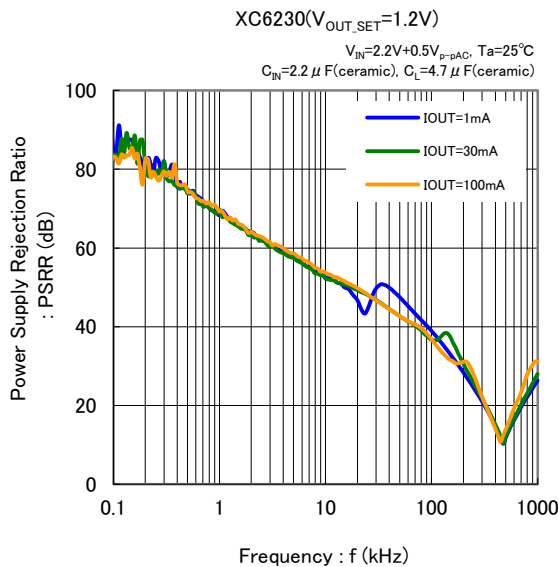

■ PACKAGING INFORMATION

For the latest package information go to, www.torexsemi.com/technical-support/packages

PACKAGE	OUTLINE / LAND PATTERN	THERMAL CHARACTERISTICS	
SOP-8FD	SOP-8FD PKG	Standard Board	SOP-8FD Power Dissipation
		JESD51-7 Board	
USP-6C	USP-6C PKG	Standard Board	USP-6C Power Dissipation
		JESD51-7 Board	

MARKING RULE

● USP-6C

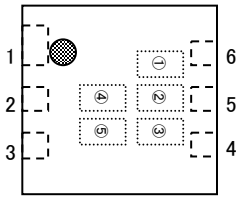

①,②,③ represents product series

MARK	PRODUCT SERIES
0A1	XC6230H001**-G
0B1	XC6230S001**-G

● SOP-8FD

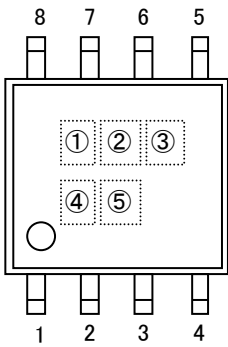

④,⑤ represents production lot number

01 to 09, 0A to 0Z, 11 to 9Z, A1 to A9, AA to AZ, B1 to ZZ repeated
(G, I, J, O, Q, W excluded)

*No character inversion used.

1. The product and product specifications contained herein are subject to change without notice to improve performance characteristics. Consult us, or our representatives before use, to confirm that the information in this datasheet is up to date.
2. The information in this datasheet is intended to illustrate the operation and characteristics of our products. We neither make warranties or representations with respect to the accuracy or completeness of the information contained in this datasheet nor grant any license to any intellectual property rights of ours or any third party concerning with the information in this datasheet.
3. Applicable export control laws and regulations should be complied and the procedures required by such laws and regulations should also be followed, when the product or any information contained in this datasheet is exported.
4. The product is neither intended nor warranted for use in equipment of systems which require extremely high levels of quality and/or reliability and/or a malfunction or failure which may cause loss of human life, bodily injury, serious property damage including but not limited to devices or equipment used in 1) nuclear facilities, 2) aerospace industry, 3) medical facilities, 4) automobile industry and other transportation industry and 5) safety devices and safety equipment to control combustions and explosions. Do not use the product for the above use unless agreed by us in writing in advance.
5. Although we make continuous efforts to improve the quality and reliability of our products; nevertheless Semiconductors are likely to fail with a certain probability. So in order to prevent personal injury and/or property damage resulting from such failure, customers are required to incorporate adequate safety measures in their designs, such as system fail safes, redundancy and fire prevention features.
6. Our products are not designed to be Radiation-resistant.
7. Please use the product listed in this datasheet within the specified ranges.
8. We assume no responsibility for damage or loss due to abnormal use.
9. All rights reserved. No part of this datasheet may be copied or reproduced unless agreed by Torex Semiconductor Ltd in writing in advance.

TOREX SEMICONDUCTOR LTD.