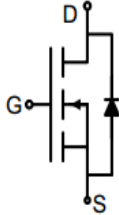
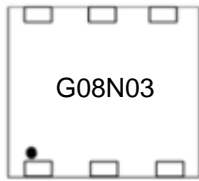
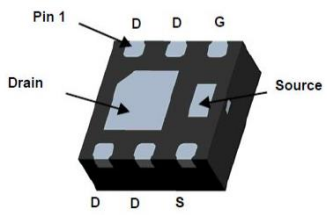

N-Channel Enhancement Mode Power MOSFET

<p>Description</p> <p>The G08N03D2 uses advanced trench technology to provide excellent $R_{DS(ON)}$, low gate charge. It can be used in a wide variety of applications.</p> <p>General Features</p> <ul style="list-style-type: none"> ● V_{DS} 30V ● I_D (at $V_{GS} = 10V$) 8A ● $R_{DS(ON)}$ (at $V_{GS} = 10V$) < 20mΩ ● $R_{DS(ON)}$ (at $V_{GS} = 5V$) < 30mΩ ● 100% Avalanche Tested ● RoHS Compliant <p>Application</p> <ul style="list-style-type: none"> ● Power switch ● DC/DC converters 		 <p>Schematic diagram</p>  <p>Marking and pin assignment</p>  <p>DFN2*2</p>	
Device	Package	Marking	Packaging
G08N03D2	DFN2*2	G08N03	3000pcs/Reel

Absolute Maximum Ratings $T_C = 25^{\circ}C$, unless otherwise noted			
Parameter	Symbol	Value	Unit
Drain-Source Voltage	V_{DS}	30	V
Continuous Drain Current	I_D	8	A
Pulsed Drain Current (note1)	I_{DM}	32	A
Gate-Source Voltage	V_{GS}	± 20	V
Power Dissipation	P_D	17	W
Operating Junction and Storage Temperature Range	T_J, T_{stg}	-55 To 150	$^{\circ}C$

Thermal Resistance			
Parameter	Symbol	Value	Unit
Thermal Resistance, Junction-to-Case	R_{thJC}	6.2	$^{\circ}C/W$

Specifications $T_J = 25^\circ\text{C}$, unless otherwise noted						
Parameter	Symbol	Test Conditions	Value			Unit
			Min.	Typ.	Max.	
Static Parameters						
Drain-Source Breakdown Voltage	$V_{(BR)DSS}$	$V_{GS} = 0V, I_D = 250\mu\text{A}$	30	--	--	V
Zero Gate Voltage Drain Current	I_{DSS}	$V_{DS} = 30V, V_{GS} = 0V$	--	--	1	μA
Gate-Source Leakage	I_{GSS}	$V_{GS} = \pm 20V$	--	--	± 100	nA
Gate-Source Threshold Voltage	$V_{GS(th)}$	$V_{DS} = V_{GS}, I_D = 250\mu\text{A}$	1	1.7	2	V
Drain-Source On-Resistance	$R_{DS(on)}$	$V_{GS} = 10V, I_D = 4A$	--	13	20	m Ω
		$V_{GS} = 4.5V, I_D = 4A$	--	21	30	
Forward Transconductance	g_{FS}	$V_{DS}=5V, I_D=3A$	--	30	--	S
Dynamic Parameters						
Input Capacitance	C_{iss}	$V_{GS} = 0V,$ $V_{DS} = 15V,$ $f = 1.0\text{MHz}$	--	681	--	pF
Output Capacitance	C_{oss}		--	219	--	
Reverse Transfer Capacitance	C_{rss}		--	175	--	
Total Gate Charge	Q_g	$V_{DD} = 15V,$ $I_D = 5.6A,$ $V_{GS} = 10V$	--	15	--	nC
Gate-Source Charge	Q_{gs}		--	2	--	
Gate-Drain Charge	Q_{gd}		--	4	--	
Turn-on Delay Time	$t_{d(on)}$	$V_{DD} = 15V,$ $I_D = 5A,$ $R_G = 3\Omega$	--	5	--	ns
Turn-on Rise Time	t_r		--	3.5	--	
Turn-off Delay Time	$t_{d(off)}$		--	19	--	
Turn-off Fall Time	t_f		--	3.5	--	
Drain-Source Body Diode Characteristics						
Continuous Body Diode Current	I_S	$T_C = 25^\circ\text{C}$	--	--	8	A
Body Diode Voltage	V_{SD}	$T_J = 25^\circ\text{C}, I_{SD} = 3A, V_{GS} = 0V$	--	--	1.2	V
Reverse Recovery Time	T_{rr}	$I_S = 3A, V_{GS} = 0V$ $di/dt=500A/\mu\text{s}$	--	8	--	ns

Notes

1. Repetitive Rating: Pulse width limited by maximum junction temperature
2. Identical low side and high side switch with identical R_G

Gate Charge Test Circuit



Switch Time Test Circuit



EAS Test Circuit

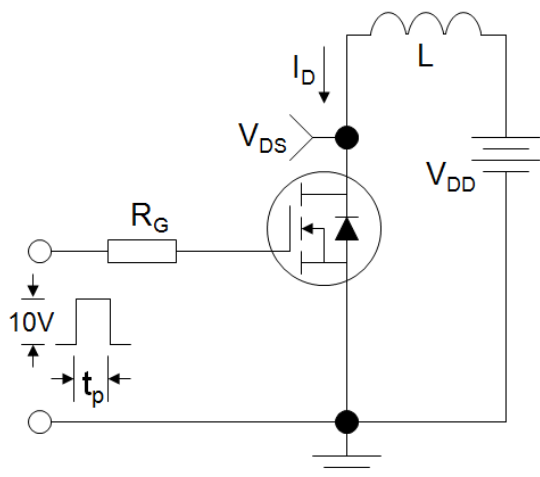

Typical Characteristics $T_J = 25^\circ\text{C}$, unless otherwise noted

Figure 1. Output Characteristics

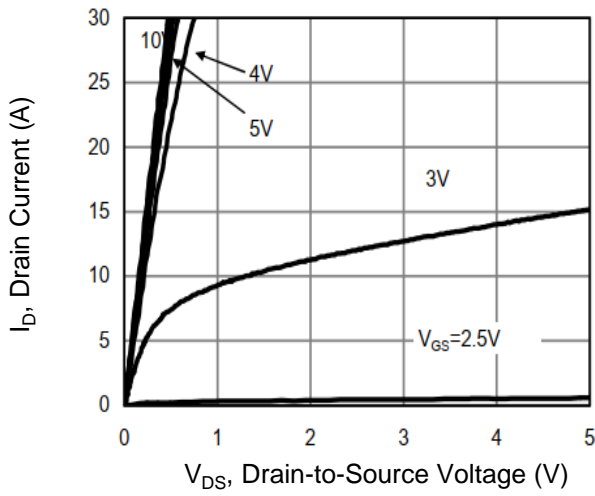

Figure 2. Transfer Characteristics

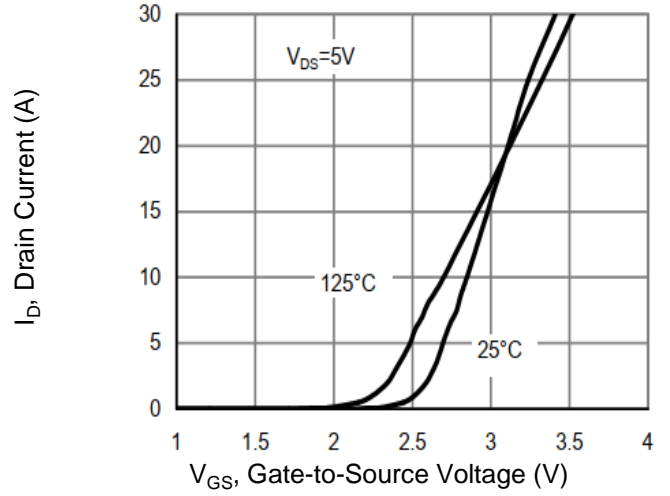

Figure 3. Gate Charge

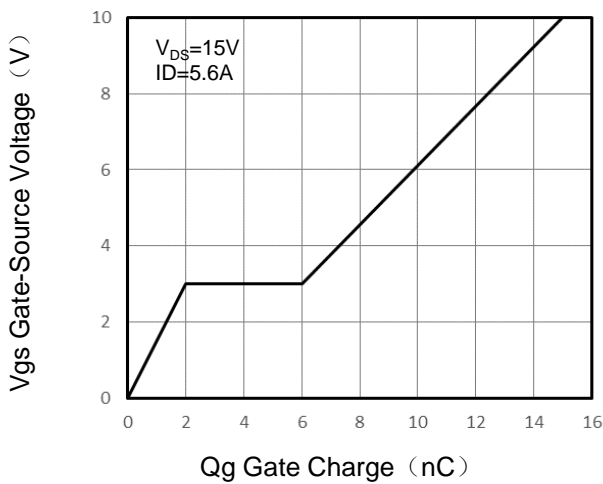

Figure 4. Drain Source On Resistance

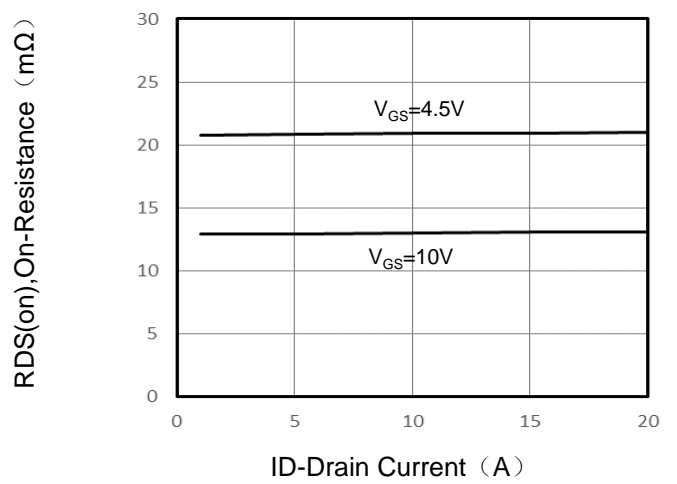

Figure 5. Capacitance

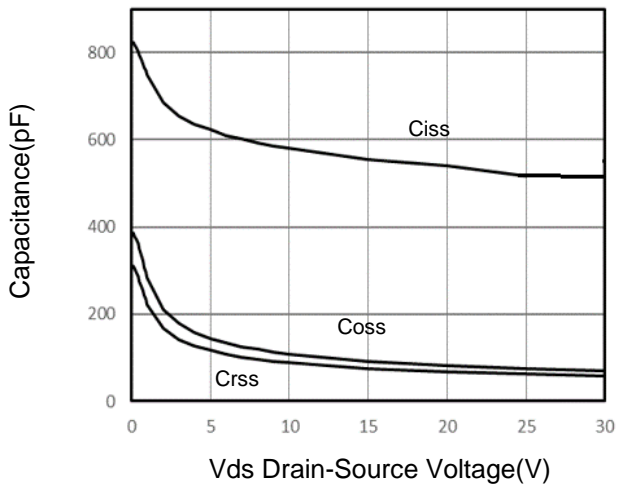
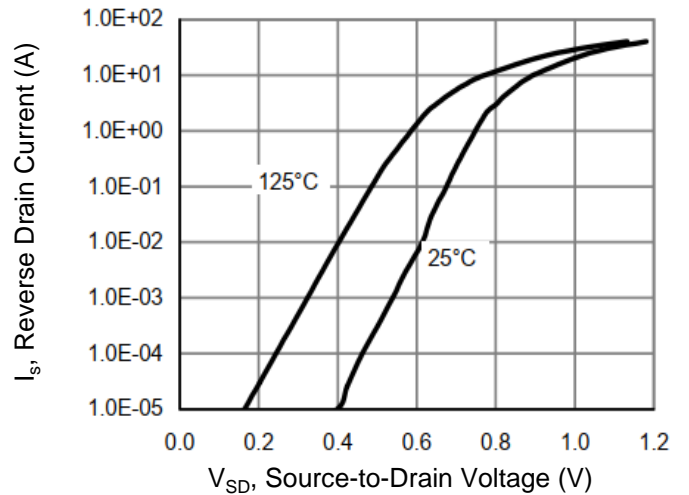

Figure 6. Source-Drain Diode Forward



Typical Characteristics $T_J = 25^\circ\text{C}$, unless otherwise noted

Figure 7. Drain-Source On-Resistance

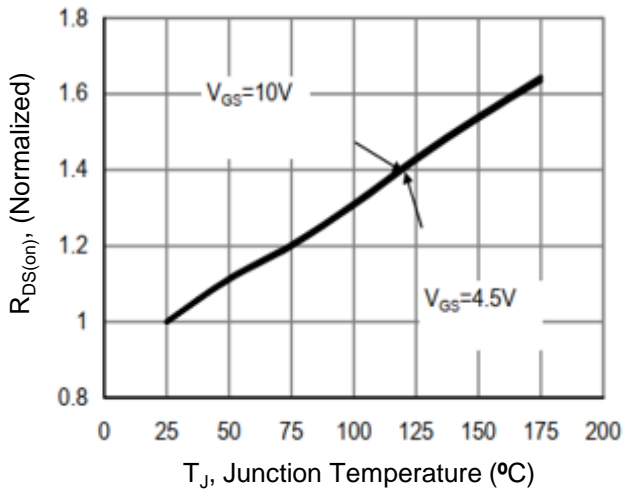

Figure 8. Safe Operation Area

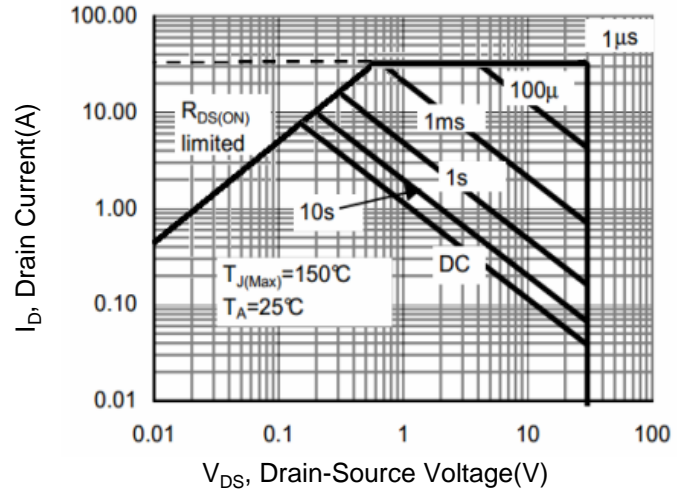
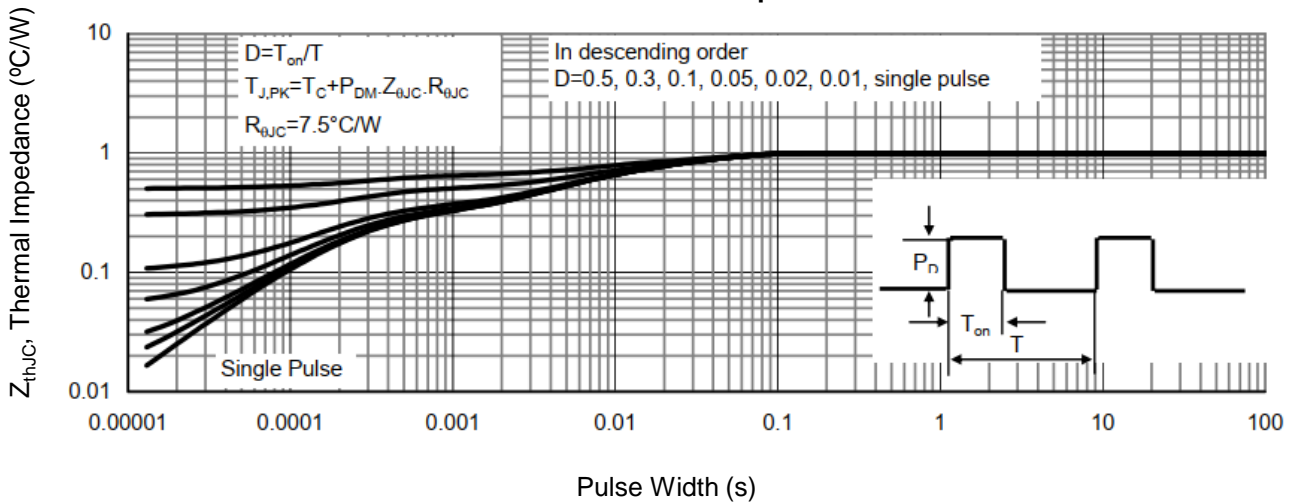
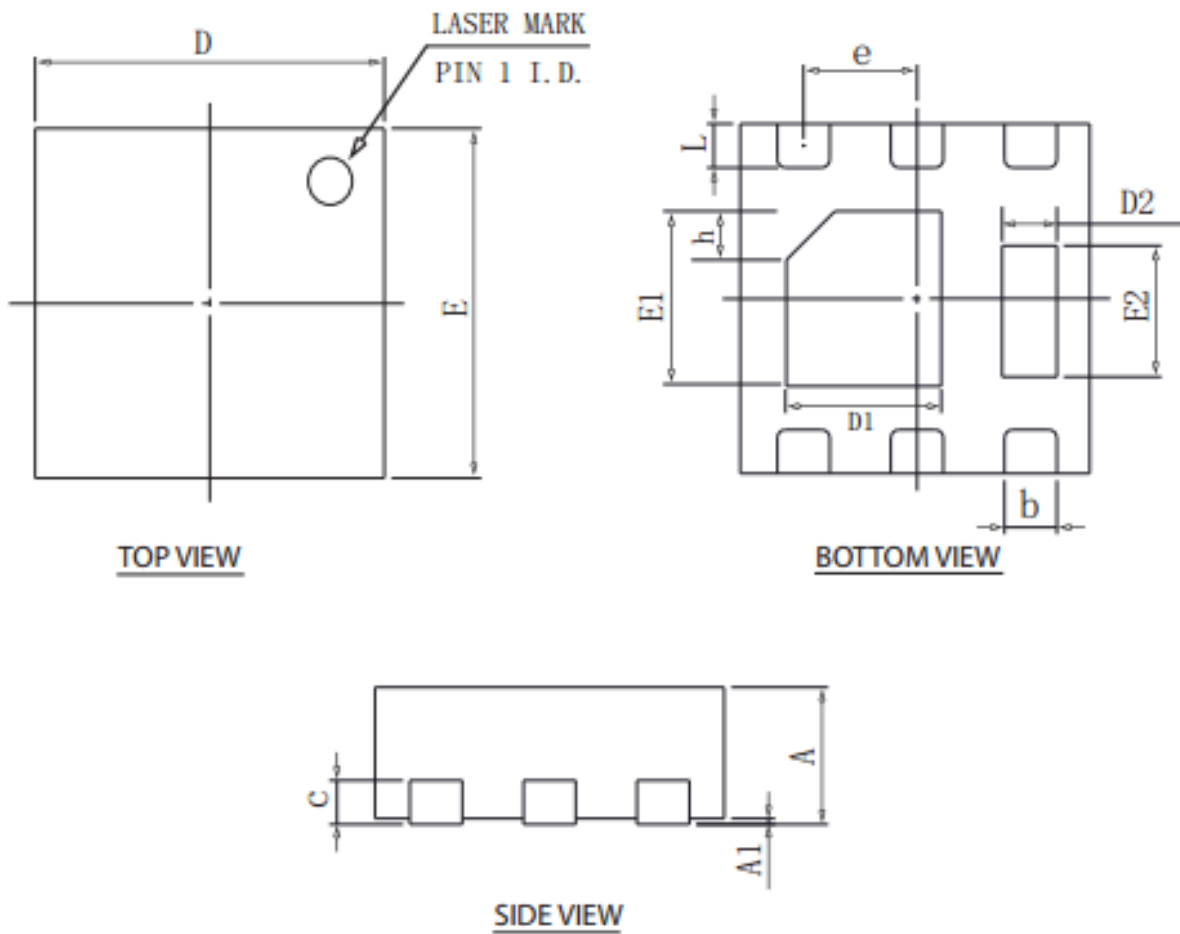

Figure 9. Normalized Maximum Transient Thermal Impedance



DFN2x2-6L Package Information



COMMON DIMENSIONS

SYMBOL	mm		
	MIN	NOM	MAX
A	0.70	0.75	0.80
A1	NA	0.02	0.05
b	0.20	0.27	0.34
c	0.18	0.20	0.25
D	1.95	2.00	2.07
E	1.95	2.00	2.07
D1	0.80	0.90	1.00
E1	0.90	1.00	1.10
D2	0.20	0.30	0.40
E2	0.65	0.75	0.85
L	0.20	0.25	0.35
h	0.20	0.25	0.30
e	0.65BSC		