

Features

- Axial lead type devices for through hole design
- High current capability.
- Superfast recovery time for switching mode application,
- High surge capability.
- Glass passivated chip junction structure.
- Lead-free parts meet RoHS requirements.
- Suffix "-H" indicates Halogen free parts, ex. SF31G-H.

Mechanical data

- Epoxy : UL94-V0 rated flame retardant
- Case : Molded plastic, DO-201AD
- Lead : Axial leads, solderable per MIL-STD-202, Method 208 guaranteed
- Polarity: Color band denotes cathode end
- Mounting Position : Any

Package outline

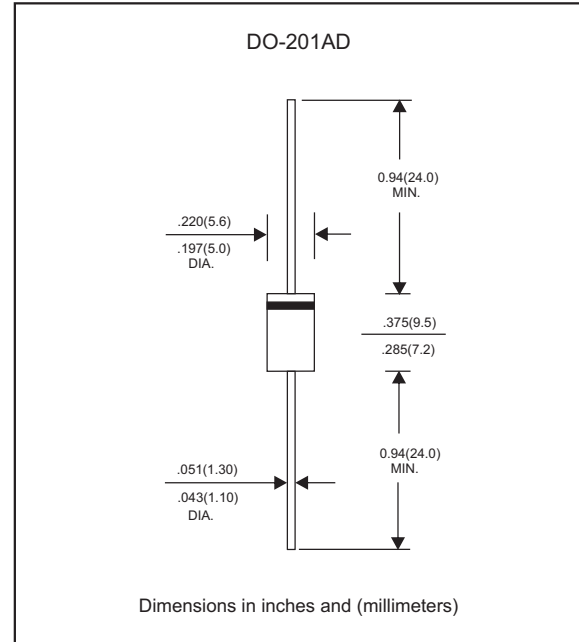

Maximum ratings and Electrical Characteristics (AT $T_A=25^\circ\text{C}$ unless otherwise noted)

PARAMETER	CONDITIONS	Symbol	MIN.	TYP.	MAX.	UNIT
Forward rectified current	Ambient temperature = 55°C	I_O			3.0	A
Forward surge current	8.3ms single half sine-wave (JEDEC methode)	I_{FSM}			125	A
Reverse current	$V_R = V_{RRM}$ $T_J = 25^\circ\text{C}$	I_R			5.0	μA
	$V_R = V_{RRM}$ $T_J = 125^\circ\text{C}$				100	
Thermal resistance	Junction to ambient	$R_{\theta JA}$		20		$^\circ\text{C/W}$
	Junction to case	$R_{\theta JC}$		12		$^\circ\text{C/W}$
	Junction to lead	$R_{\theta JL}$		8		$^\circ\text{C/W}$
Diode junction capacitance	f=1MHz and applied 4V DC reverse voltage	C_J		50		pF
Storage temperature		T_{STG}	-65		+175	$^\circ\text{C}$

SYMBOLS	V_{RRM}^{*1} (V)	V_{RMS}^{*2} (V)	V_R^{*3} (V)	V_F^{*4} (V)	t_{rr}^{*5} (ns)	Operating temperature T_J , ($^\circ\text{C}$)
SF31G	50	35	50	0.95	35	-55 to +150
SF32G	100	70	100			
SF33G	150	105	150			
SF34G	200	140	200			
SF35G	300	210	300	1.25	35	-55 to +150
SF36G	400	280	400			
SF37G	500	350	500			
SF38G	600	420	600	1.70	35	-55 to +150

- *1 Repetitive peak reverse voltage
- *2 RMS voltage
- *3 Continuous reverse voltage
- *4 Maximum forward voltage@ $I_F=3.0\text{A}$
- *5 Maximum Reverse recovery time, note 1

Note 1. Reverse recovery time test condition, $I_F=0.5\text{A}$, $I_R=1.0\text{A}$, $I_{RR}=0.25\text{A}$

Rating and characteristic curves

FIG.1- TEST CIRCUIT DIAGRAM AND REVERSE RECOVERY TIME CHARACTERISTIC

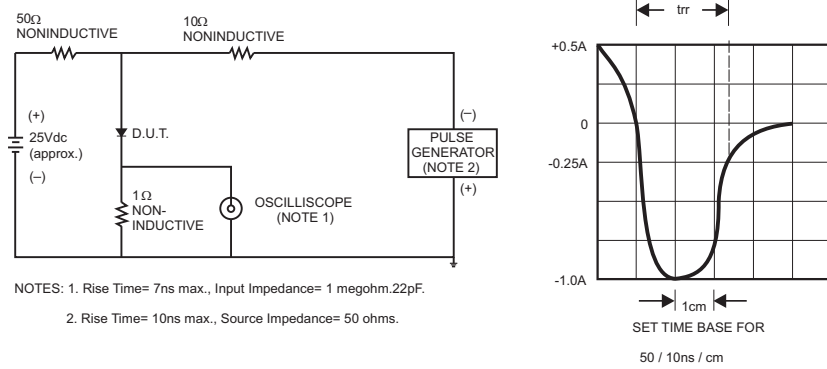

FIG.2-TYPICAL FORWARD CURRENT DERATING CURVE

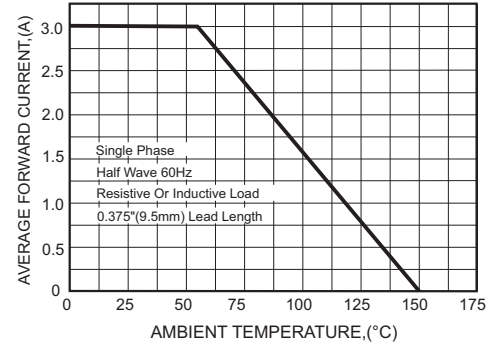

FIG.3-TYPICAL FORWARD CHARACTERISTICS

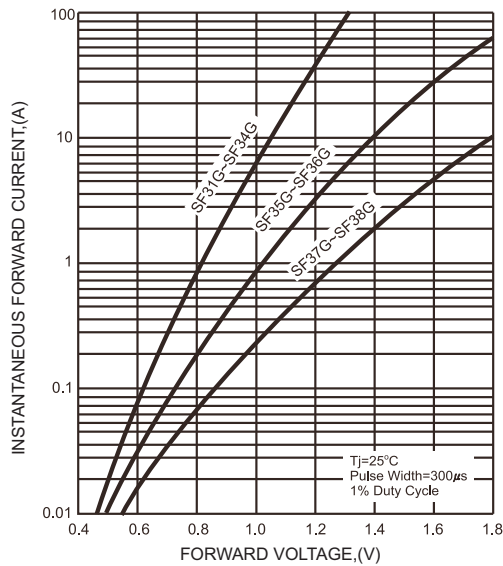

FIG.4-TYPICAL REVERSE CHARACTERISTICS

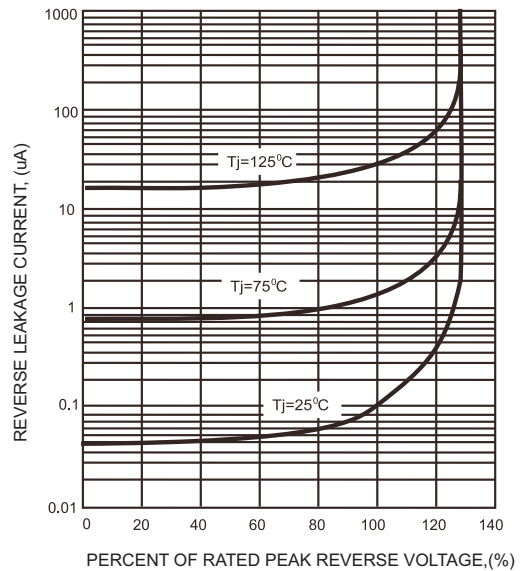

FIG.5-MAXIMUM NON-REPETITIVE FORWARD SURGE CURRENT

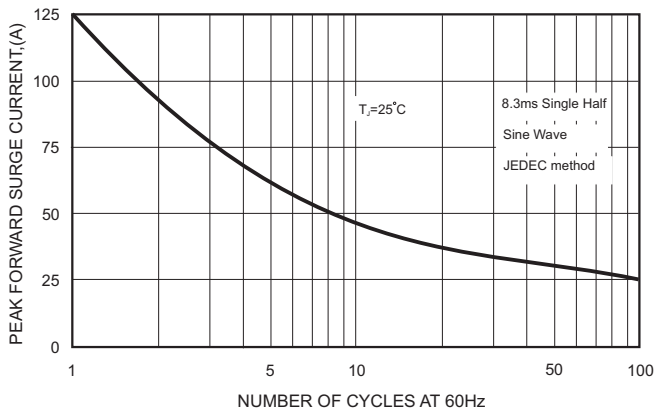
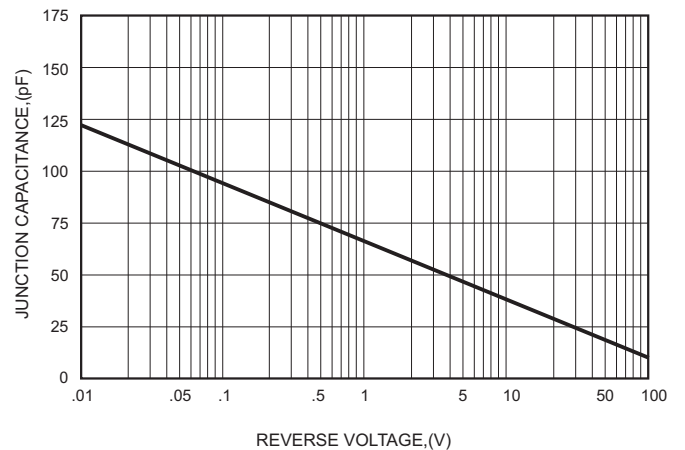

FIG.6-TYPICAL JUNCTION CAPACITANCE



Pinning information

Pin	Simplified outline	Symbol
Pin1 cathode Pin2 anode		

Marking

Type number	Marking code	Example	
SF31G	SF31G	For Halogen Device 	For Halogen-free Device
SF32G	SF32G		
SF33G	SF33G		
SF34G	SF34G		
SF35G	SF35G		
SF36G	SF36G		
SF37G	SF37G		
SF38G	SF38G		

Taping specifications for AXIAL devices

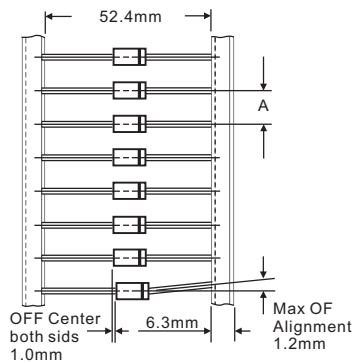

AMMO PACKING

DEVICE CASE TYPE	Q'TY 1 (PCS / BOX)	INNER BOX SIZE (m/m)	CARTON SIZE (m/m)	Q'TY 2 (PCS / CARTON)	APPROX. CROSS WEIGHT(kg)
DO-201AD	1,250	258 * 75 * 143	405 * 270 * 320	12,500	14.0

Suggested thermal profiles for soldering processes

1. Lead free temperature profile wave-soldering

