

OPA277/OPA2277/OPA4277

High Precision Operational Amplifiers

1 Features

- Ultralow Offset Voltage: 10 μV
- Ultralow Drift: $\pm 0.1 \mu\text{V}/^\circ\text{C}$
- High Open-Loop Gain: 134 dB
- High Common-Mode Rejection: 140 dB
- High Power Supply Rejection: 130 dB
- Low Bias Current: 1-nA maximum
- Wide Supply Range: $\pm 2 \text{ V}$ to $\pm 18 \text{ V}$
- Low Quiescent Current: 800 μA /amplifier
- Single, Dual, and Quad Versions

2 Applications

- Transducer Amplifiers
- Bridge Amplifiers
- Temperature Measurements
- Strain Gage Amplifiers
- Precision Integrators
- Battery-Powered Instruments
- Test Equipment

3 Description

The OPAx277 series precision operational amplifiers replace the industry standard OPA177. They offer improved noise, wider output voltage swing, and are twice as fast with half the quiescent current. Features include ultralow offset voltage and drift, low bias current, high common-mode rejection, and high power supply rejection. Single, dual, and quad versions have identical specifications, for maximum design flexibility.

OPAx277 series operational amplifiers operate from $\pm 2\text{-V}$ to $\pm 18\text{-V}$ supplies with excellent performance. Unlike most operational amplifiers which are specified at only one supply voltage, the OPAx277 series is specified for real-world applications; a single limit applies over the $\pm 5\text{-V}$ to $\pm 15\text{-V}$ supply range. High performance is maintained as the amplifiers swing to their specified limits. Because the initial offset voltage ($\pm 20 \mu\text{V}$ maximum) is so low, user adjustment is usually not required. However, the single version (OPA277) provides external trim pins for special applications.

OPA277 operational amplifiers are easy to use and free from phase inversion and the overload problems found in some other operational amplifiers. They are stable in unity gain and provide excellent dynamic behavior over a wide range of load conditions. Dual and quad versions feature completely independent circuitry for lowest crosstalk and freedom from interaction, even when overdriven or overloaded.

Device Information⁽¹⁾

PART NUMBER	PACKAGE	BODY SIZE (NOM)
OPA277 OPA2277	VSON (8)	4.00 mm x 4.00 mm
	SOIC (8)	3.91 mm x 4.90 mm
	PDIP (8)	6.35 mm x 9.81 mm
OPA4277	SOIC (14)	3.91 mm x 8.65 mm
	PDIP (14)	6.35 mm x 19.30 mm

(1) For all available packages, see the orderable addendum at the end of the data sheet.

0.1 Hz to 10 Hz Noise

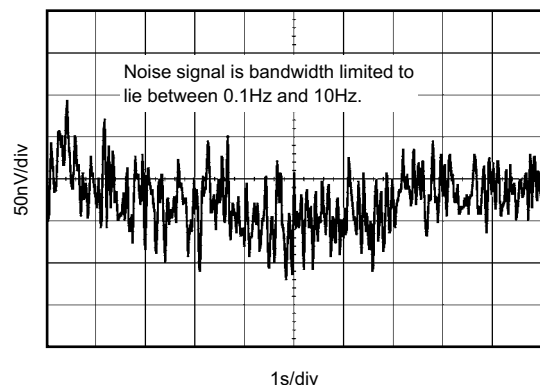

4 Pin Configuration and Functions

OPA277P and D Packages
8-Pin PDIP and SOIC
Top View

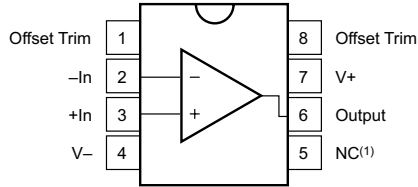

OPA277 DRM Package
8-Pin VSON
Top View

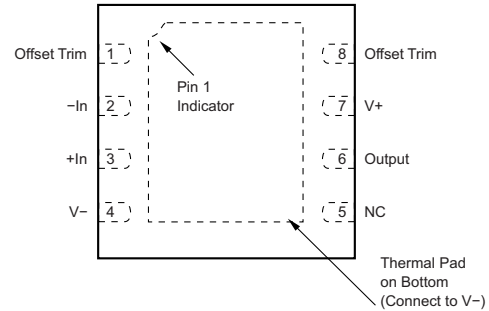

Pin Functions: OPA277

PIN		I/O	DESCRIPTION
NO.	NAME		
1	Offset Trim	I	Input offset voltage trim (leave floating if not used)
2	-In	I	Inverting input
3	+In	I	Noninverting input
4	V-	—	Negative (lowest) power supply
5	NC	—	No internal connection (can be left floating)
6	Output	O	Output
7	V+	—	Positive (highest) power supply
8	Offset Trim	—	Input offset voltage trim (leave floating if not used)

OPA2277P and D Packages
8-Pin PDIP and SOIC
Top View

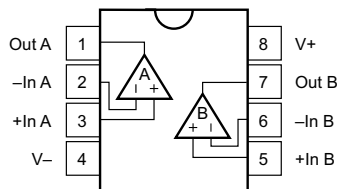

OPA2277DRM Package
8-Pin VSON
Top View

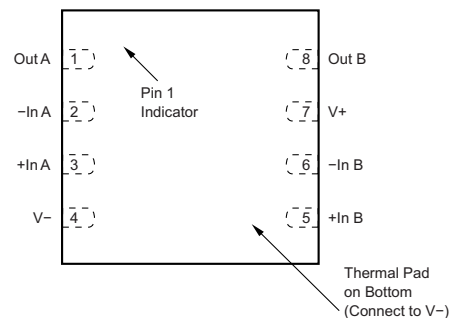

Pin Functions: OPA2277

PIN			I/O	DESCRIPTION
NAME	PDIP, SOIC NO.	DFN NO.		
Out A	1	1	O	Output channel A
-In A	2	2	I	Inverting input channel A
+In A	3	3	I	Noninverting input channel A
V-	4	4	—	Negative (lowest) power supply
+In B	5	5	I	Noninverting input channel B
-In B	6	6	I	Inverting input channel B
Out B	7	8	O	Output channel B
V+	8	7	—	Positive (highest) power supply

**OPA4277P and D Packages
14 Pins PDIP and SOIC
Top View**

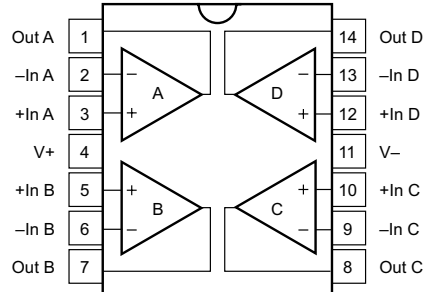

Pin Functions: OPA4277

PIN		I/O	DESCRIPTION
NO.	NAME		
1	Out A	O	Output channel A
2	-In A	I	Inverting input channel A
3	+In A	I	Noninverting input channel A
4	V+	—	Positive (highest) power supply
5	+In B	I	Noninverting input channel B
6	-In B	I	Inverting input channel B
7	Out B	O	Output channel B
8	Out C	O	Output channel C
9	-In C	I	Inverting input channel C
10	+In C	I	Noninverting input channel C
11	V-	—	Negative (lowest) power supply
12	+In D	I	Noninverting input channel D
13	-In D	I	Inverting input channel D
14	Out D	O	Output channel D

5 Specifications

5.1 Absolute Maximum Ratings

over operating free-air temperature range (unless otherwise noted) ⁽¹⁾

	MIN	MAX	UNIT
Supply voltage, $V_s = (V+) - (V-)$		36	V
Input voltage	(V-) -0.7	(V+) +0.7	V
Output short-circuit ⁽²⁾	Continuous		
Operating temperature	-55	125	°C
Junction temperature		150	°C
Lead temperature		300	°C
Storage temperature, T_{stg}	-55	125	°C

- (1) Stresses beyond those listed under *Absolute Maximum Ratings* may cause permanent damage to the device. These are stress ratings only, which do not imply functional operation of the device at these or any other conditions beyond those indicated under *Recommended Operating Conditions*. Exposure to absolute-maximum-rated conditions for extended periods may affect device reliability.
- (2) Short-circuit to ground, one amplifier per package.

5.2 ESD Ratings

		VALUE	UNIT
$V_{(ESD)}$ Electrostatic discharge	Human-body model (HBM), per ANSI/ESDA/JEDEC JS-001 ⁽¹⁾	±2000	V
	Charged-device model (CDM), per JEDEC specification JESD22-C101 ⁽²⁾	±500	

- (1) JEDEC document JEP155 states that 500-V HBM allows safe manufacturing with a standard ESD control process.
- (2) JEDEC document JEP157 states that 250-V CDM allows safe manufacturing with a standard ESD control process.

5.3 Recommended Operating Conditions

over operating free-air temperature range (unless otherwise noted)

	MIN	NOM	MAX	UNIT
Supply voltage, $V_s = (V+) - (V-)$	4 (±2)	30 (±15)	36 (±18)	V
Specified temperature	-40		+85	°C

5.4 Thermal Information for OPA277

THERMAL METRIC ⁽¹⁾	OPA277			UNIT
	P (PDIP)	D (SOIC)	DRM (VSON)	
	8 PINS			
$R_{\theta JA}$ Junction-to-ambient thermal resistance	49.2	110.1	40.7	°C/W
$R_{\theta JC(top)}$ Junction-to-case (top) thermal resistance	39.4	52.2	41.3	°C/W
$R_{\theta JB}$ Junction-to-board thermal resistance	26.4	52.3	16.7	°C/W
Ψ_{JT} Junction-to-top characterization parameter	15.4	10.4	0.6	°C/W
Ψ_{JB} Junction-to-board characterization parameter	26.3	51.5	16.9	°C/W
$R_{\theta JC(bot)}$ Junction-to-case (bottom) thermal resistance	—	—	3.3	°C/W

- (1) For more information about traditional and new thermal metrics, see the *Semiconductor and IC Package Thermal Metrics* application report, [SPRA953](#).

5.5 Thermal Information for OPA2277

THERMAL METRIC ⁽¹⁾	OPA2277			UNIT
	P (PDIP)	D (SOIC)	DRM (VSON)	
	8 PINS			
$R_{\theta JA}$ Junction-to-ambient thermal resistance	47.2	107.4	39.3	°C/W
$R_{\theta JC(top)}$ Junction-to-case (top) thermal resistance	36.0	45.8	36.9	°C/W

- (1) For more information about traditional and new thermal metrics, see the *Semiconductor and IC Package Thermal Metrics* application report, [SPRA953](#).

Thermal Information for OPA2277(continued)

THERMAL METRIC ⁽¹⁾		OPA2277			UNIT
		P (PDIP)	D (SOIC)	DRM (VSON)	
		8 PINS			
R _{θJB}	Junction-to-board thermal resistance	24.4	47.9	15.4	°C/W
ψ _{JT}	Junction-to-top characterization parameter	13.4	5.7	0.4	°C/W
ψ _{JB}	Junction-to-board characterization parameter	24.3	47.3	15.6	°C/W
R _{θJC(bot)}	Junction-to-case (bottom) thermal resistance	—	—	2.2	°C/W

5.6 Thermal Information for OPA4277

THERMAL METRIC ⁽¹⁾		OPA4277		UNIT
		D (SOIC)	P (PDIP)	
		14 PINS		
R _{θJA}	Junction-to-ambient thermal resistance	67.0	66.3	°C/W
R _{θJC(top)}	Junction-to-case (top) thermal resistance	24.1	20.5	°C/W
R _{θJB}	Junction-to-board thermal resistance	22.5	26.8	°C/W
ψ _{JT}	Junction-to-top characterization parameter	2.2	2.1	°C/W
ψ _{JB}	Junction-to-board characterization parameter	22.1	26.2	°C/W
R _{θJC(bot)}	Junction-to-case (bottom) thermal resistance	—	—	°C/W

(1) For more information about traditional and new thermal metrics, see the *Semiconductor and IC Package Thermal Metrics* application report, [SPRA953](#).

5.7 Electrical Characteristics for OPAx277P, OPAx277U, and OPAx277xA

At T_A = 25°C, and R_L = 2 kΩ, unless otherwise noted

PARAMETER		TEST CONDITIONS	OPA277PJ OPA2277PJ			OPA277xA OPA2277xA OPA4277xA			UNIT
			MIN	TYP ⁽¹⁾	MAX	MIN	TYP ⁽¹⁾	MAX	
OFFSET VOLTAGE									
V _{OS}	Input Offset Voltage			±10	±20		±20	±50	μV
	Input Offset Voltage Over Temperature	OPA277P,U (high-grade, single) OPA2277P,U (high-grade, dual) All PA, UA, Versions AIDRM Versions	T _A = -40°C to 85°C		±30				μV
					±50				
							±100		
dV _{OS} /dT	Input Offset Voltage Drift	OPA277P,U (high-grade, single) OPA2277P,U (high-grade, dual) All PA, UA, AIDRM Versions	T _A = -40°C to 85°C		±0.1	±0.15			μV/°C
					±0.1	±0.25			
							±0.15	±1	
	Input Offset Voltage: (all models)	vs Time		0.2			See ⁽²⁾		μV/mo
		vs Power Supply (PSRR)	V _S = ±2 V to ±18 V T _A = -40°C to 85°C		±0.3	±0.5		See ⁽²⁾	±1
	Channel Separation (dual, quad)	DC		0.1			See ⁽²⁾		μV/V

(1) V_S = ±15 V

(2) Specifications are the same as OPA277P,U.

Electrical Characteristics for OPAX277P, OPAX277U, and OPAX277xA (continued)

At $T_A = 25^\circ\text{C}$, and $R_L = 2\text{ k}\Omega$, unless otherwise noted

PARAMETER		TEST CONDITIONS	OPA277PJ OPA2277PJ			OPA277xA OPA2277xA OPA4277xA			UNIT
			MIN	TYP ⁽¹⁾	MAX	MIN	TYP ⁽¹⁾	MAX	
INPUT BIAS CURRENT									
I_B	Input Bias Current	$T_A = -40^\circ\text{C}$ to 85°C		± 0.5	± 1		See ⁽²⁾	± 2.8	nA
					± 2			± 4	
I_{OS}	Input Offset Current	$T_A = -40^\circ\text{C}$ to 85°C		± 0.5	± 1		See ⁽²⁾	± 2.8	nA
					± 2			± 4	
NOISE									
	Input Voltage Noise, $f = 0.1$ to 10 Hz			0.22			See ⁽²⁾		μV_{PP}
e_n	Input Voltage Noise Density			$f = 10\text{ Hz}$			See ⁽²⁾		nV/ $\sqrt{\text{Hz}}$
				$f = 100\text{ Hz}$	12		See ⁽²⁾		
				$f = 1\text{ kHz}$	8		See ⁽²⁾		
				$f = 10\text{ kHz}$	8		See ⁽²⁾		
i_n	Current Noise Density, $f = 1\text{ kHz}$			0.2			See ⁽²⁾	pA/ $\sqrt{\text{Hz}}$	
INPUT VOLTAGE RANGE									
V_{CM}	Common-Mode Voltage Range			$(V_-)+2$	$(V_+)-2$		See ⁽²⁾	See ⁽²⁾	V
CMRR	Common-Mode Rejection	$V_{CM} = (V_-)+2\text{ V}$ to $(V_+)-2\text{ V}$		130	140		115	See ⁽²⁾	dB
		$T_A = -40^\circ\text{C}$ to 85°C		128			115		
INPUT IMPEDANCE									
	Differential			100 3			See ⁽²⁾		M Ω pF
	Common-Mode	$V_{CM} = (V_-)+2\text{ V}$ to $(V_+)-2\text{ V}$		250 3			See ⁽²⁾		G Ω pF
OPEN-LOOP GAIN									
A_{OL}	Open-Loop Voltage Gain	$V_O = (V_-)+0.5\text{ V}$ to $(V_+)-1.2\text{ V}$, $R_L = 10\text{ k}\Omega$		140			See ⁽²⁾		dB
		$V_O = (V_-)+1.5\text{ V}$ to $(V_+)-1.5\text{ V}$, $R_L = 2\text{ k}\Omega$		126	134		See ⁽²⁾	See ⁽²⁾	
		$V_O = (V_-)+1.5\text{ V}$ to $(V_+)-1.5\text{ V}$, $R_L = 2\text{ k}\Omega$		126			See ⁽²⁾		dB
		$T_A = -40^\circ\text{C}$ to 85°C							
FREQUENCY RESPONSE									
GBW	Gain-Bandwidth Product			1			See ⁽²⁾		MHz
SR	Slew Rate			0.8			See ⁽²⁾		V/ μs
	Settling Time	0.1%	$V_S = \pm 15\text{ V}$, $G = 1$, 10-V Step	14			See ⁽²⁾		μs
		0.01%		16		See ⁽²⁾			
	Overload Recovery Time	$V_{IN} \times G = V_S$		3			See ⁽²⁾		μs
THD+N	Total Harmonic Distortion + Noise	1 kHz, $G = 1$, $V_O = 3.5\text{ V}_{rms}$		0.002%			See ⁽²⁾		

Electrical Characteristics for OPAx277P, OPAx277U, and OPAx277xA(continued)

At $T_A = 25^\circ\text{C}$, and $R_L = 2\text{ k}\Omega$, unless otherwise noted

PARAMETER	TEST CONDITIONS	OPA277PJ OPA2277PJ			OPA277xA OPA2277xA OPA4277xA			UNIT
		MIN	TYP ⁽¹⁾	MAX	MIN	TYP ⁽¹⁾	MAX	
OUTPUT								
V_O	Voltage Output	$R_L = 10\text{ k}\Omega$	(V-)+0.5	(V+)-1.2	See ⁽²⁾	See ⁽²⁾	V	
		$T_A = -40^\circ\text{C}$ to $+85^\circ\text{C}$	(V-)+0.5	(V+)-1.2	See ⁽²⁾	See ⁽²⁾		
		$R_L = 2\text{ k}\Omega$	(V-)+1.5	(V+)-1.5	See ⁽²⁾	See ⁽²⁾		
		$T_A = -40^\circ\text{C}$ to $+85^\circ\text{C}$	(V-)+1.5	(V+)-1.5	See ⁽²⁾	See ⁽²⁾		
I_{SC}	Short-Circuit Current		± 35		See ⁽²⁾		mA	
C_{LOAD}	Capacitive Load Drive		See ⁽³⁾					
Z_O	Open-loop output impedance	$f = 1\text{ MHz}$	40		See ⁽²⁾		Ω	
POWER SUPPLY								
V_S	Specified Voltage Range		± 5	± 15	See ⁽²⁾	See ⁽²⁾	V	
	Operating Voltage Range		± 2	± 18	See ⁽²⁾	See ⁽²⁾	V	
I_Q	Quiescent Current (per amplifier)	$I_O = 0$	± 790	± 825	See ⁽²⁾	See ⁽²⁾	μA	
		$T_A = -40^\circ\text{C}$ to 85°C		± 900		See ⁽²⁾		See ⁽²⁾
TEMPERATURE RANGE								
	Specified Range		-40	85	See ⁽²⁾	See ⁽²⁾	$^\circ\text{C}$	
	Operating Range		-55	125	See ⁽²⁾	See ⁽²⁾	$^\circ\text{C}$	

(3) See *Typical Characteristics*

6.8 Electrical Characteristics for OPAx277AIDRM

At $T_A = 25^\circ\text{C}$, and $R_L = 2\text{ k}\Omega$, unless otherwise noted

PARAMETER	TEST CONDITIONS	OPA277AIDRM OPA2277AIDRM			UNIT	
		MIN	TYP ⁽¹⁾	MAX		
OFFSET VOLTAGE						
V_{OS}	Input Offset Voltage		± 35	± 100	μV	
	Input Offset Voltage Over Temperature	OPA277P,U (high-grade, single)	$T_A = -40^\circ\text{C}$ to 85°C		μV	
		OPA2277P,U (high-grade, dual)				
		All PA, UA, Versions				
		AIDRM Versions				± 165
dV_{OS}/dT	Input Offset Voltage Drift	OPA277P,U (high-grade, single)	$T_A = -40^\circ\text{C}$ to 85°C		$\mu\text{V}/^\circ\text{C}$	
		OPA2277P,U (high-grade, dual)				
		All PA, UA, AIDRM Versions				± 0.15
	Input Offset Voltage: (all models)	vs Time		See ⁽²⁾	$\mu\text{V}/\text{mo}$	
		vs Power Supply (PSRR)	$V_S = \pm 2\text{ V}$ to $\pm 18\text{ V}$	See ⁽²⁾	± 1	$\mu\text{V}/\text{V}$
			$T_A = -40^\circ\text{C}$ to 85°C		± 1	
	Channel Separation (dual, quad)	DC		See ⁽²⁾	$\mu\text{V}/\text{V}$	

(1) $V_S = \pm 15\text{ V}$

(2) Specifications are the same as OPA277P, U.

Electrical Characteristics for OPAx277AIDRM (continued)

At $T_A = 25^\circ\text{C}$, and $R_L = 2\text{ k}\Omega$, unless otherwise noted

PARAMETER		TEST CONDITIONS	OPA277AIDRM OPA2277AIDRM			UNIT
			MIN	TYP ⁽¹⁾	MAX	
INPUT BIAS CURRENT						
I_B	Input Bias Current	$T_A = -40^\circ\text{C}$ to 85°C			± 2.8 ± 4	nA
I_{OS}	Input Offset Current	$T_A = -40^\circ\text{C}$ to 85°C			± 2.8 ± 4	nA
NOISE						
	Input Voltage Noise, $f = 0.1$ to 10 Hz			See ⁽²⁾		μV_{PP}
e_n	Input Voltage Noise Density	$f = 10\text{ Hz}$		See ⁽²⁾		nV/ $\sqrt{\text{Hz}}$
		$f = 100\text{ Hz}$		See ⁽²⁾		
		$f = 1\text{ kHz}$		See ⁽²⁾		
		$f = 10\text{ kHz}$		See ⁽²⁾		
i_n	Current Noise Density, $f = 1\text{ kHz}$			See ⁽²⁾		pA/ $\sqrt{\text{Hz}}$
INPUT VOLTAGE RANGE						
V_{CM}	Common-Mode Voltage Range			See ⁽²⁾	See ⁽²⁾	V
CMRR	Common-Mode Rejection	$V_{CM} = (V_-) + 2\text{ V}$ to $(V_+) - 2\text{ V}$	115	See ⁽²⁾		dB
		$T_A = -40^\circ\text{C}$ to 85°C	115			
INPUT IMPEDANCE						
	Differential			See ⁽²⁾		M Ω pF
	Common-Mode	$V_{CM} = (V_-) + 2\text{ V}$ to $(V_+) - 2\text{ V}$		See ⁽²⁾		G Ω pF
OPEN-LOOP GAIN						
A_{OL}	Open-Loop Voltage Gain	$V_O = (V_-) + 0.5\text{ V}$ to $(V_+) - 1.2\text{ V}$, $R_L = 10\text{ k}\Omega$		See ⁽²⁾		dB
		$V_O = (V_-) + 1.5\text{ V}$ to $(V_+) - 1.5\text{ V}$, $R_L = 2\text{ k}\Omega$	See ⁽²⁾	See ⁽²⁾		
		$V_O = (V_-) + 1.5\text{ V}$ to $(V_+) - 1.5\text{ V}$, $R_L = 2\text{ k}\Omega$		See ⁽²⁾		dB
		$T_A = -40^\circ\text{C}$ to 85°C				
FREQUENCY RESPONSE						
GBW	Gain-Bandwidth Product			See ⁽²⁾		MHz
SR	Slew Rate			See ⁽²⁾		V/ μs
	Settling Time	0.1%	$V_S = \pm 15\text{ V}$, $G = 1$, 10-V Step	See ⁽²⁾		μs
		0.01%		See ⁽²⁾		
	Overload Recovery Time	$V_{IN} \times G = V_S$		See ⁽²⁾		μs
THD+N	Total Harmonic Distortion + Noise	1 kHz, $G = 1$, $V_O = 3.5\text{ V}_{rms}$		See ⁽²⁾		
OUTPUT						
V_O	Voltage Output	$R_L = 10\text{ k}\Omega$		See ⁽²⁾	See ⁽²⁾	V
		$T_A = -40^\circ\text{C}$ to $+85^\circ\text{C}$		See ⁽²⁾	See ⁽²⁾	
		$R_L = 2\text{ k}\Omega$		See ⁽²⁾	See ⁽²⁾	
		$T_A = -40^\circ\text{C}$ to $+85^\circ\text{C}$		See ⁽²⁾	See ⁽²⁾	
I_{SC}	Short-Circuit Current			See ⁽²⁾		mA
C_{LOAD}	Capacitive Load Drive					
Z_O	Open-loop output impedance	$f = 1\text{ MHz}$		See ⁽²⁾		Ω

Electrical Characteristics for OPAx277AIDRM (continued)

At $T_A = 25^\circ\text{C}$, and $R_L = 2\text{ k}\Omega$, unless otherwise noted

PARAMETER		TEST CONDITIONS	OPA277AIDRM OPA2277AIDRM			UNIT
			MIN	TYP ⁽¹⁾	MAX	
POWER SUPPLY						
V_S	Specified Voltage Range		See ⁽²⁾		See ⁽²⁾	V
	Operating Voltage Range		See ⁽²⁾		See ⁽²⁾	V
I_Q	Quiescent Current (per amplifier)	$I_O = 0$		See ⁽²⁾	See ⁽²⁾	μA
		$T_A = -40^\circ\text{C}$ to 85°C			See ⁽²⁾	
TEMPERATURE RANGE						
	Specified Range		See ⁽²⁾		See ⁽²⁾	$^\circ\text{C}$
	Operating Range		See ⁽²⁾		See ⁽²⁾	$^\circ\text{C}$

6.9 Typical Characteristics

At $T_A = 25^\circ\text{C}$, $V_S = \pm 15\text{ V}$, and $R_L = 2\text{ k}\Omega$, unless otherwise noted.

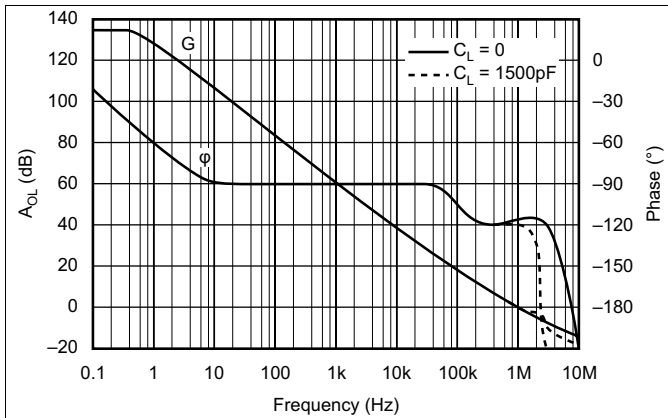

Figure 1. Open-Loop Gain and Phase vs Frequency

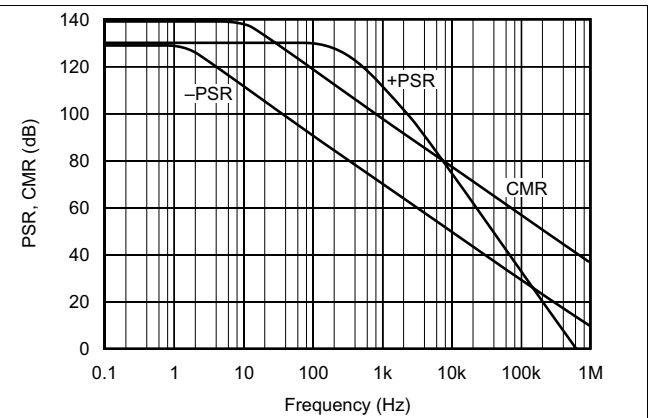

Figure 2. Power Supply and Common-Mode Rejection vs Frequency

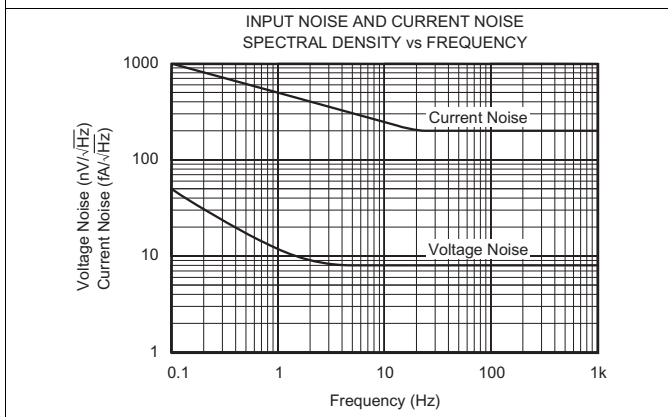

Figure 3. Input Noise and Current Noise Spectral Density vs Frequency

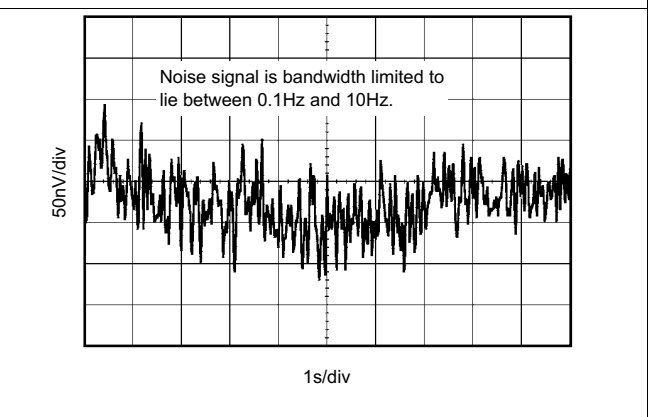

Figure 4. Input Noise Voltage vs Time

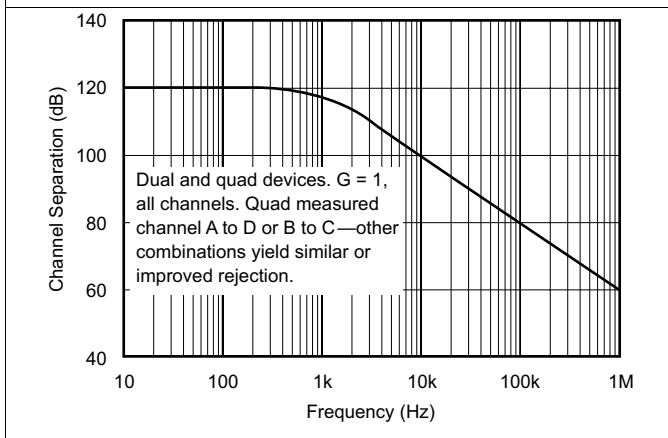

Figure 5. Channel Separation vs Frequency

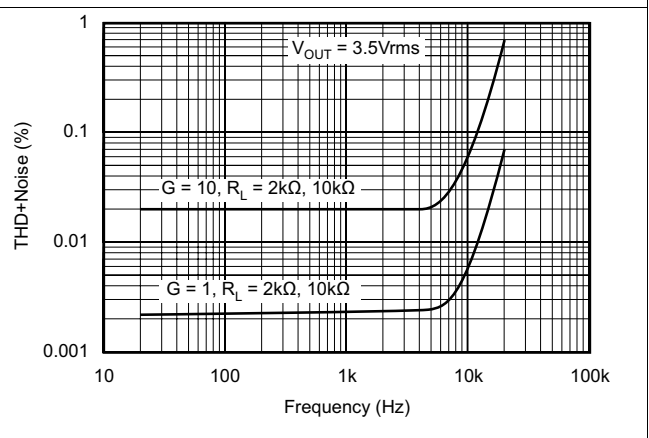

Figure 6. Total Harmonic Distortion + Noise vs Frequency

Typical Characteristics (continued)

At $T_A = 25^\circ\text{C}$, $V_S = \pm 15\text{ V}$, and $R_L = 2\text{ k}\Omega$, unless otherwise noted.

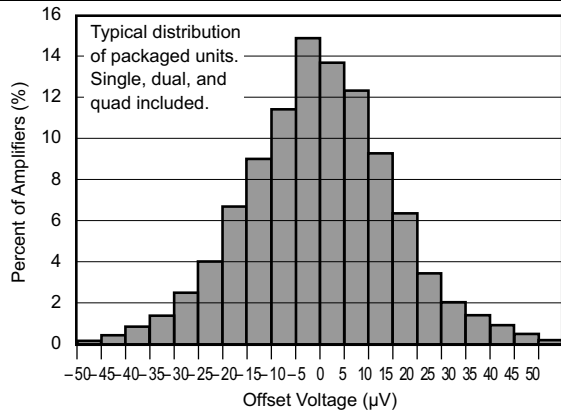

Figure 7. Offset Voltage Production Distribution

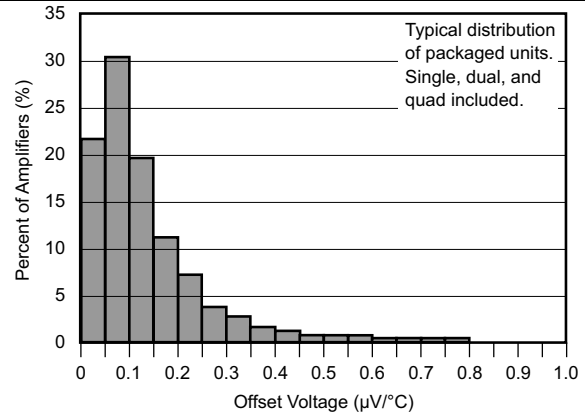

Figure 8. Offset Voltage Drift Production Distribution

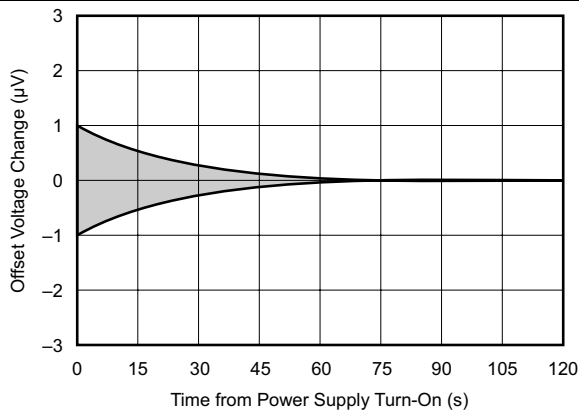

Figure 9. Warm-Up Offset Voltage Drift

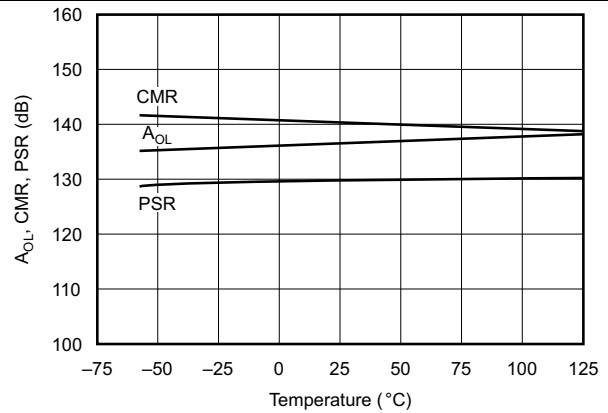

Figure 10. A_{OL} , CMR, PSR vs Temperature

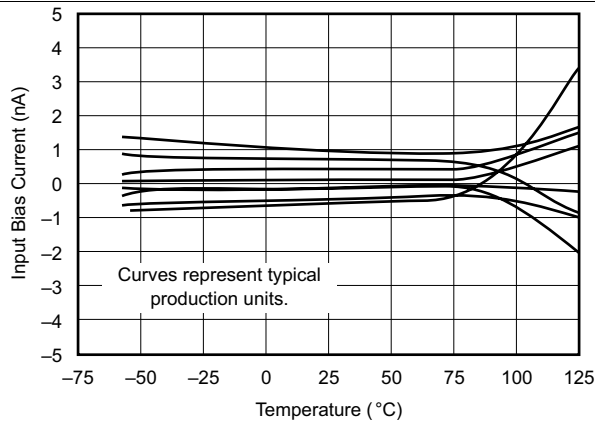

Figure 11. Input Bias Current vs Temperature

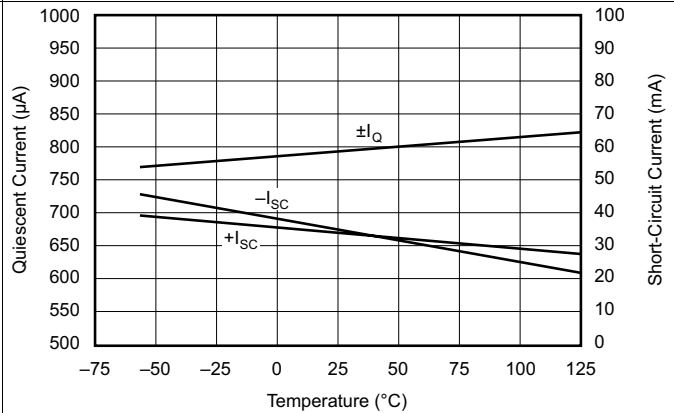

Figure 12. Quiescent Current and Short-Circuit Current vs Temperature

Typical Characteristics (continued)

At $T_A = 25^\circ\text{C}$, $V_S = \pm 15\text{ V}$, and $R_L = 2\text{ k}\Omega$, unless otherwise noted.

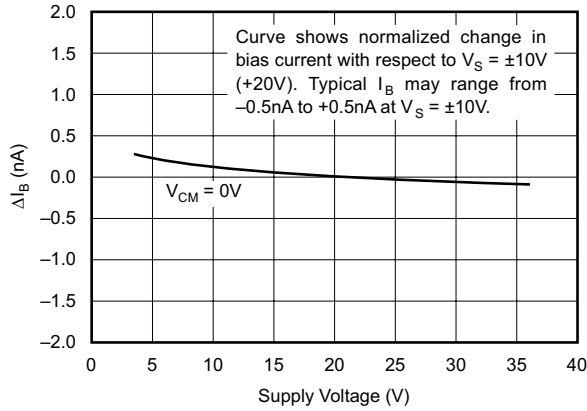

Figure 13. Change in Input Bias Current vs Power Supply Voltage

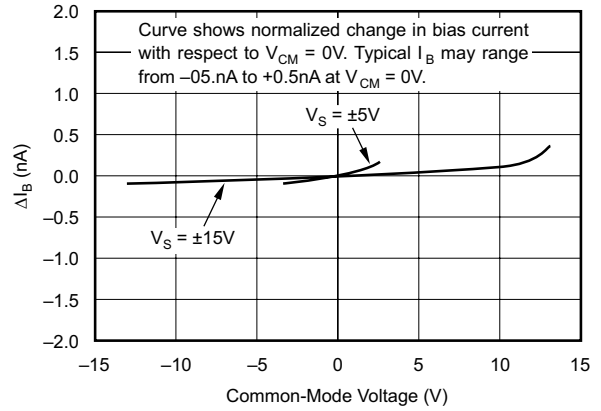

Figure 14. Change in Input Bias Current vs Common-Mode Voltage

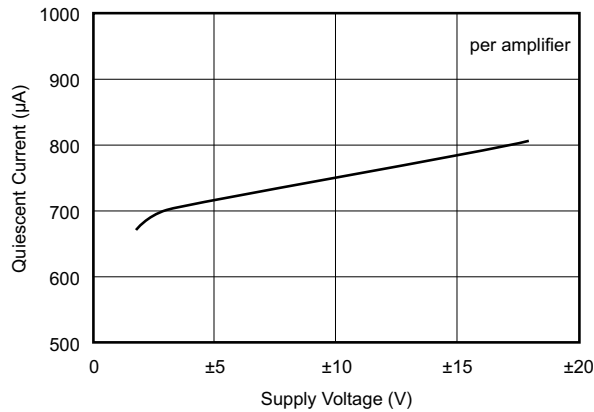

Figure 15. Quiescent Current vs Supply Voltage

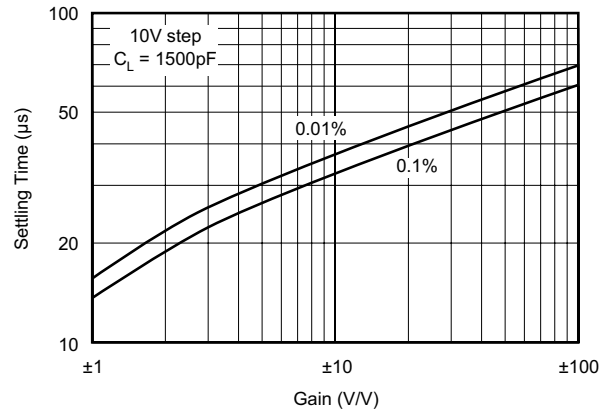

Figure 16. Settling Time vs Closed-Loop Gain

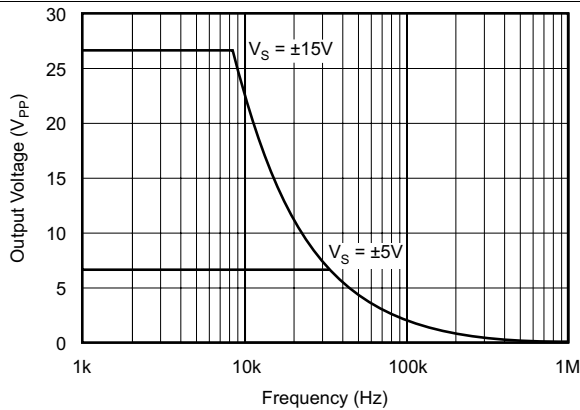

Figure 17. Maximum Output Voltage vs Frequency

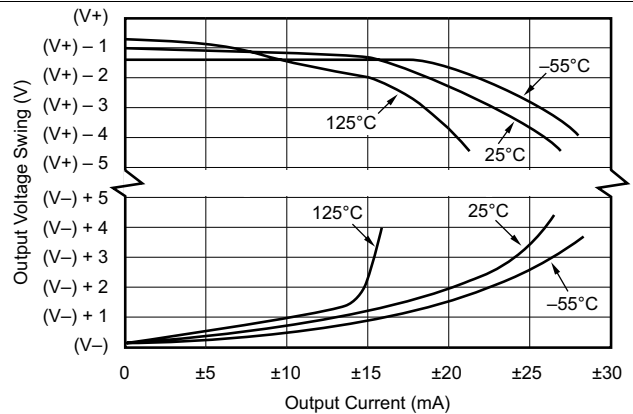

Figure 18. Output Voltage Swing vs Output Current

Typical Characteristics (continued)

At $T_A = 25^\circ\text{C}$, $V_S = \pm 15\text{ V}$, and $R_L = 2\text{ k}\Omega$, unless otherwise noted.

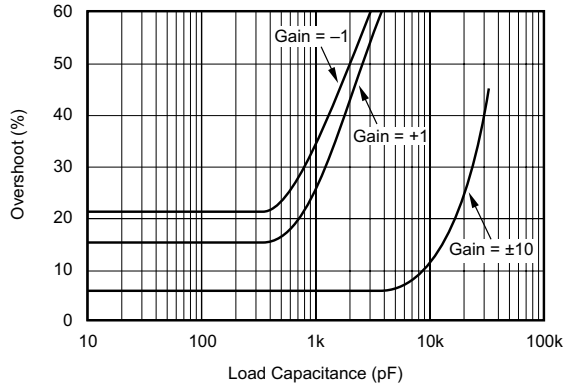

Figure 19. Small-Signal Overshoot vs Load Capacitance

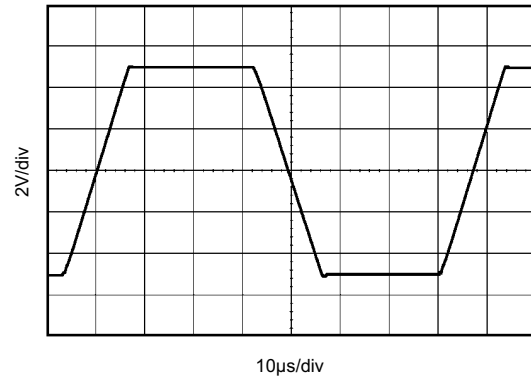

Figure 20. Large-Signal Step Response
 $G = 1$, $C_L = 1500\text{ pF}$, $V_S = \pm 15\text{ V}$

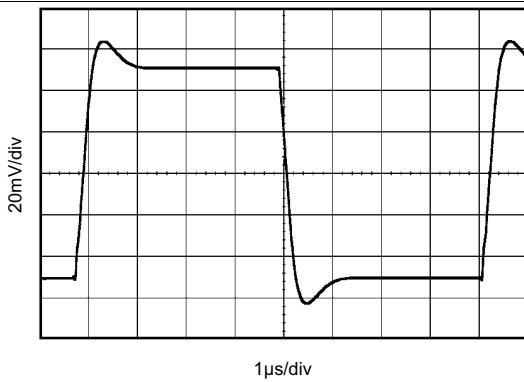

Figure 21. Small-Signal Step Response
 $G = +1$, $C_L = 0$, $V_S = \pm 15\text{ V}$

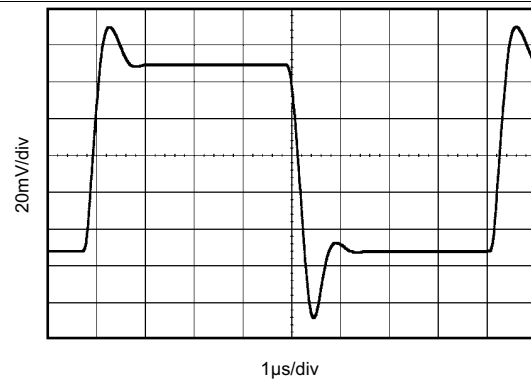

Figure 22. Small-Signal Step Response
 $G = 1$, $C_L = 1500\text{ pF}$, $V_S = \pm 15\text{ V}$

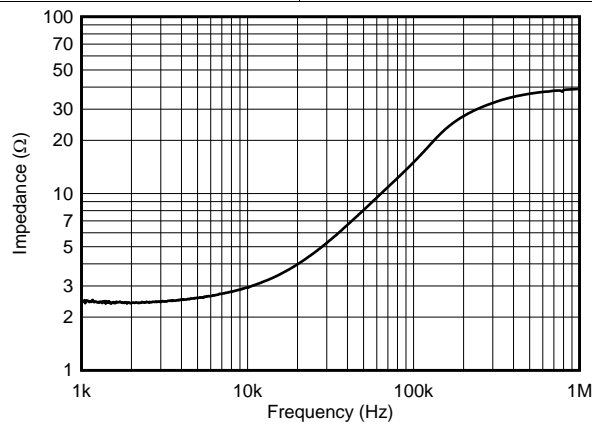

Figure 23. Open-Loop Output Impedance
 $V_S = \pm 15\text{ V}$

7 Detailed Description

7.1 Overview

The OPAx277 series precision operational amplifiers replace the industry standard OPA177. They offer improved noise, wider output voltage swing, and are twice as fast with half the quiescent current. Features include ultralow offset voltage and drift, low bias current, high common-mode rejection, and high power supply rejection. Single, dual, and quad versions have identical specifications, for maximum design flexibility.

7.2 Functional Block Diagram

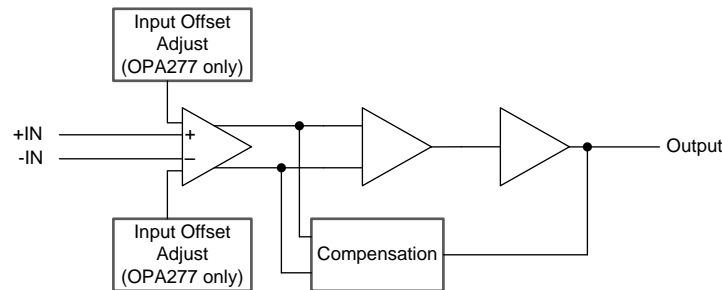

7.3 Feature Description

The OPAx277 series is unity-gain stable and free from unexpected output phase reversal, making it easy to use in a wide range of applications. Applications with noisy or high-impedance power supplies may require decoupling capacitors close to the device pins. In most cases 0.1- μ F capacitors are adequate.

The OPAx277 series has low offset voltage and drift. To achieve highest performance, the circuit layout and mechanical conditions should be optimized. Offset voltage and drift can be degraded by small thermoelectric potentials at the operational amplifier inputs. Connections of dissimilar metals generate thermal potential, which can degrade the ultimate performance of the OPAx277 series. These thermal potentials can be made to cancel by assuring that they are equal in both input terminals.

- Keep the thermal mass of the connections to the two input terminals similar
- Locate heat sources as far as possible from the critical input circuitry
- Shield operational amplifier and input circuitry from air currents, such as cooling fans

7.3.1 Operating Voltage

OPAx277 series operational amplifiers operate from ± 2 -V to ± 18 -V supplies with excellent performance. Unlike most operational amplifiers, which are specified at only one supply voltage, the OPA277 series is specified for real-world applications; a single limit applies over the ± 5 -V to ± 15 -V supply range. This allows a customer operating at $V_S = \pm 10$ V to have the same assured performance as a customer using ± 15 -V supplies. In addition, key parameters are assured over the specified temperature range, -40°C to 85°C . Most behavior remains unchanged through the full operating voltage range (± 2 V to ± 18 V). Parameters which vary significantly with operating voltage or temperature are shown in [Typical Characteristics](#).

7.3.2 Offset Voltage Adjustment

The OPAx277 series is laser-trimmed for low offset voltage and drift, so most circuits do not require external adjustment. However, offset voltage trim connections are provided on pins 1 and 8. Offset voltage can be adjusted by connecting a potentiometer, as shown in [Figure 24](#). Only use this adjustment to null the offset of the operational amplifier. This adjustment should not be used to compensate for offsets created elsewhere in a system, because this can introduce additional temperature drift.

Feature Description (continued)

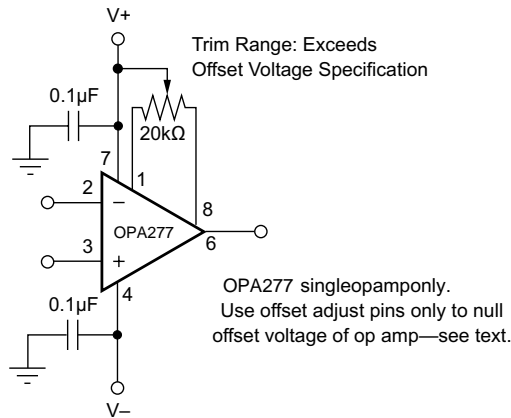

Figure 24. OPA277 Offset Voltage Trim Circuit

7.3.3 Input Protection

The inputs of the OPAx277series are protected with 1-kΩ series input resistors and diode clamps. The inputs can withstand ±30-V differential inputs without damage. The protection diodes conduct current when the inputs are over-driven. This may disturb the slewing behavior of unity-gain follower applications, but will not damage the operational amplifier.

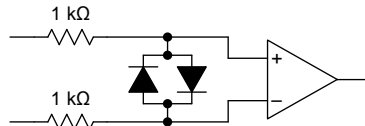

Figure 25. OPAx277 Input Protection

7.3.4 Input Bias Current Cancellation

The input stage base current of the OPAx277series is internally compensated with an equal and opposite cancellation circuit. The resulting input bias current is the difference between the input stage base current and the cancellation current. This residual input bias current can be positive or negative.

When the bias current is canceled in this manner, the input bias current and input offset current are approximately the same magnitude. As a result, it is not necessary to use a bias current cancellation resistor, as is often done with other operational amplifiers (see Figure 26). A resistor added to cancel input bias current errors may actually increase offset voltage and noise.

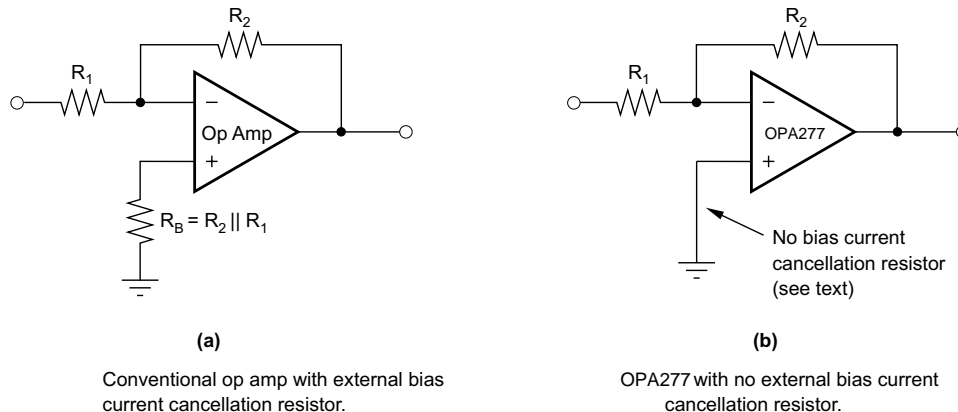

Figure 26. Input Bias Current Cancellation

Feature Description (continued)

7.3.5 EMI Rejection Ratio (EMIRR)

The electromagnetic interference (EMI) rejection ratio, or EMIRR, describes the EMI immunity of operational amplifiers. An adverse effect that is common to many operational amplifiers is a change in the offset voltage as a result of RF signal rectification. An operational amplifier that is more efficient at rejecting this change in offset as a result of EMI has a higher EMIRR and is quantified by a decibel value. Measuring EMIRR can be performed in many ways, but this report provides the EMIRR IN+, which specifically describes the EMIRR performance when the RF signal is applied to the noninverting input pin of the operational amplifier. In general, only the noninverting input is tested for EMIRR for the following three reasons:

1. Operational amplifier input pins are known to be the most sensitive to EMI, and typically rectify RF signals better than the supply or output pins.
2. The noninverting and inverting operational amplifier inputs have symmetrical physical layouts and exhibit nearly matching EMIRR performance.
3. EMIRR is easier to measure on noninverting pins than on other pins because the noninverting input terminal can be isolated on a printed circuit board (PCB). This isolation allows the RF signal to be applied directly to the noninverting input terminal with no complex interactions from other components or connecting PCB traces.

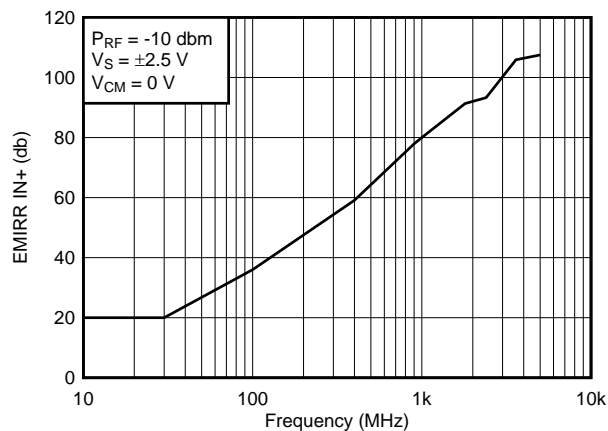

Figure 27. OPA277 EMIRR IN+ vs Frequency

If available, any dual and quad operational amplifier device versions have nearly similar EMIRR IN+ performance. The OPA277 unity-gain bandwidth is 1 MHz. EMIRR performance below this frequency denotes interfering signals that fall within the operational amplifier bandwidth.

Feature Description (continued)

Table 1 shows the EMIRR IN+ values for the OPA277 at particular frequencies commonly encountered in real-world applications. Applications listed in Table 1 may be centered on or operated near the particular frequency shown. This information may be of special interest to designers working with these types of applications, or working in other fields likely to encounter RF interference from broad sources, such as the industrial, scientific, and medical (ISM) radio band.

Table 1. OPA277 EMIRR IN+ for Frequencies of Interest

FREQUENCY	APPLICATION/ALLOCATION	EMIRR IN+
400 MHz	Mobile radio, mobile satellite/space operation, weather, radar, UHF	59.1 dB
900 MHz	GSM, radio com/nav./GPS (to 1.6 GHz), ISM, aeronautical mobile, UHF	77.9 dB
1.8 GHz	GSM, mobile personal comm. broadband, satellite, L-band	91.3 dB
2.4 GHz	802.11b/g/n, Bluetooth™, mobile personal comm., ISM, amateur radio/satellite, S-band	93.3 dB
3.6 GHz	Radiolocation, aero comm./nav., satellite, mobile, S-band	105.9 dB
5.0 GHz	802.11a/n, aero comm./nav., mobile comm., space/satellite operation, C-band	107.5 dB

7.3.5.1 EMIRR IN+ Test Configuration

Figure 28 shows the circuit configuration for testing the EMIRR IN+. An RF source is connected to the operational amplifier noninverting input terminal using a transmission line. The operational amplifier is configured in a unity gain buffer topology with the output connected to a low-pass filter (LPF) and a digital multimeter (DMM). Note that a large impedance mismatch at the operational amplifier input causes a voltage reflection; however, this effect is characterized and accounted for when determining the EMIRR IN+. The resulting dc offset voltage is sampled and measured by the multimeter. The LPF isolates the multimeter from residual RF signals that may interfere with multimeter accuracy. Refer to SBOA128 for more details.

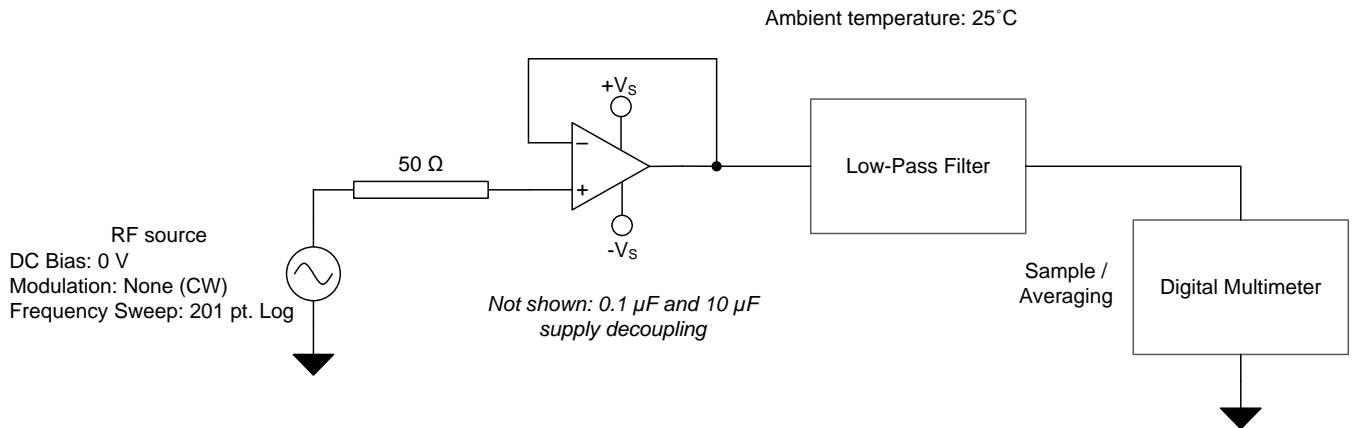

Figure 28. EMIRR IN+ Test Configuration Schematic

7.4 Device Functional Modes

The OPAx277 has a single functional mode and is operational when the power-supply voltage is greater than 4 V (±2 V). The maximum power supply voltage for the OPAx277 is 36 V (±18 V).

Important statement:

Huaguan Semiconductor Co,Ltd. reserves the right to change the products and services provided without notice. Customers should obtain the latest relevant information before ordering, and verify the timeliness and accuracy of this information.

Customers are responsible for complying with safety standards and taking safety measures when using our products for system design and machine manufacturing to avoid potential risks that may result in personal injury or property damage.

Our products are not licensed for applications in life support, military, aerospace, etc., so we do not bear the consequences of the application of these products in these fields.

Our documentation is only permitted to be copied without any tampering with the content, so we do not accept any responsibility or liability for the altered documents.