



Product Name	PHD series	Rev.	A
Part Number.	20004	Date	2009-08-01
CONN TYPE	2.0 mm WTB CONN	Page	1/7

Product Specification

Prepared by : Zhang Wen Jing

Date : 2009.08.01

Checked by : Zhang Ren Chuan

Date : 2009.08.01

Approved by : Ren An De

Date : 2009.08.01

Product Name	PHD series	Rev.	A
Part Number.	20004	Date	2009-08-01
CONN TYPE	2.0 mm WTB CONN	Page	3/7

1. SCOPE: (适用范围)

1.1 This specification covers production and inspection of Model PHD Connector.

本规范内容适用于本公司 PHD 型条形连接器产品的生产与检验。

2. Product Classification: (产品分类)

2.1 Poles: 4~60.

接触件数目: 4~60.

2.2 Catalog Identification:

产品型号示例:

30 female contact Housing: PHD-30Y.

具有 30 个阴接触件的 PHD 型连接器: PHD-30Y.

30 male contact Wafer: PHD-30A.

具有 30 个阳接触件的 PHD 型连接器: PHD-30A.

3. USE CONDITION: (使用条件)

3.1 Ambient temperature Range(环境温度): $-25^{\circ}\text{C} \sim +85^{\circ}\text{C}$.

3.2 Applicable Wire Sizes(适用线规): AWG#28~#22.

Insulation O. D. $\varnothing 0.9$ to 1.5mm.

3.3 Applicable PC board thickness(适用 PC 板厚度): 1.6 mm.

4. Appearance and Dimension: (外观及尺寸)

4.1 Appearance(外观): Product surface without defect: dirt, crack, and mechanical damage, contact without rust, plating not oxidized and not peeled.

产品表面不应有对制品有害的缺陷、污垢、裂痕及机械损伤; 接触件无锈蚀、镀层氧化、脱落等现象。

4.2 Dimension(外形尺寸): According to drawings. 依照附图所示。

4.3 Exchangable(互换性): Exchangable with same specification products.

Product Name	PHD series	Rev.	A
Part Number.	20004	Date	2009-08-01
CONN TYPE	2.0 mm WTB CONN	Page	4/7

相同规格应能互换.

5. Material: (材料)

P/N (零件名称)	Type (类型)	Material (材料)	Finish (表面处理)	Explain (说明)
Terminal	Contact (插簧)	Phosphor bronze (锡青铜 厚 0.2mm)	Tin Plated. 3~4 μ m	RoHS Compliant
Wafer (针座)	Contact (插针)	Brass (黄铜)	Tin Plated over Nickel	
	Plastic (塑壳)	Nylon UL94V-0 (2)	Color: White (颜色: 白色)	
Housing (孔座)	Plastic (塑壳)	Nylon UL94V-0 (2)	Color: White (颜色: 白色)	

6. Electrical Performance: (电气性能)

NO. (序号)	Item (项目)	Requirement (技术要求)
6.1	Voltage Rated (额定电压)	250V AC. DC.
6.2	Current Rated (额定电流)	3A AC. DC.
6.3	Contact Resistance (接触电阻)	≤ 20 m Ω
6.4	Insulation Resistance (绝缘电阻)	≥ 1000 M Ω
6.5	Dielectric Strength (耐压)	≥ 1000 V AC/minute

7. Mechanical Performance: (机械性能)

NO. (序号)	Item (项目)	Requirement (技术要求)
7.1	Male contact Retention force (PIN 针固定力)	≥ 15 N (per pin)

Product Name	PHD series	Rev.	A
Part Number.	20004	Date	2009-08-01
CONN TYPE	2.0 mm WTB CONN	Page	5/7

7.2	Female contact Retention force (端子固定力)	$\geq 15\text{N}$ (per pin)
7.3	Plug-in force (插入力)	$\leq 2.5\text{N}$ (per pin)
7.4	Plug-out force (拔出力)	$\geq 1\text{N}$ (per pin)

8、Endurance Characteristics: (环境性能)

NO. (序号)	Item (项目)	Requirement (技术要求)
8.1	Soldering rest (可焊性)	Time (时间): $2.5 \pm 0.5\text{S}$; Temperature (温度): $260 \pm 5^\circ\text{C}$; Area of Soldering (焊锡面): $\geq 90\%$
8.2	Resistance to Soldering Heat (耐焊接热)	Time (时间): $5 \pm 1\text{S}$; Temperature (温度): $260 \pm 5^\circ\text{C}$; Appearance (外观): No Damage (无损坏)
8.3	Heat test (耐热性)	Time (时间): 96h Temperature (温度): $+85 \pm 3^\circ\text{C}$; Appearance (外观): No Damage (无损坏) Contact resistance (接触电阻): $\leq 40\text{ m}\Omega$
8.4	Cold test (耐冷性)	Time (时间): 48h Temperature (温度): $-25 \pm 3^\circ\text{C}$; Appearance (外观): No Damage (无损坏) Contact resistance (接触电阻): $\leq 40\text{ m}\Omega$

Product Name	PHD series	Rev.	A
Part Number.	20004	Date	2009-08-01
CONN TYPE	2.0 mm WTB CONN	Page	6/7

8.5	Temperature Cycling (温度循环)	<p>Low temperature (低温) : $-25 \pm 3^{\circ}\text{C}$ High temperature (高温) : $-85 \pm 3^{\circ}\text{C}$; For 5 cycles.test after keeping in Normal condition for 30 min. 5次循环后, 放置在正常环境中 30 分钟, 再进行测试</p> <p>Appearance (外观) : No Damage (无损坏) Contact resistance (接触电阻) : $\leq 40 \text{ m}\Omega$</p>
8.6	Invariablenes humidity (恒定湿热)	<p>Temperature (温度) : $60 \pm 2^{\circ}\text{C}$ Relative humidity (相对湿度) : 90%-96% RH; Time (时间) : 96h Appearance (外观) : No Damage (无损坏) Contact resistance (接触电阻) : $\leq 40 \text{ m}\Omega$ Insulation Resistance 绝缘电阻: $\geq 1000 \text{ M}\Omega$</p>
8.7	Salt Spray (盐雾试验)	<p>Salt concentration (浓度) : $5 \pm 1\%$ Temperature (温度) : $35 \pm 2^{\circ}\text{C}$ Testing time (时间) : $16 \pm 2\text{h}$ After salt is removed by running wafer and a drop is removed , it is measured. 把试验样品从试验箱顶悬挂下来, 采用浓度为 $(5 \pm 1)\%$ 的氯化钠溶液, 连续雾化 16h, 试验后用流动的蒸馏水轻轻洗去表面沉积物. 在常温常驻湿条件下恢复 1-2h. 外观无损伤</p> <p>Appearance (外观) : No Damage (无损坏) Contact resistance (接触电阻) : $\leq 40 \text{ m}\Omega$</p>

Product Name	PHD series	Rev.	A
Part Number.	20004	Date	2009-08-01
CONN TYPE	2.0 mm WTB CONN	Page	7/7

9、Packaging Transportation Storage: (包装 运输 贮存)

9.1 Packaging(包装)

- (1) The packing of plastic inner is the plastic bag, the packing of inner terminal is panel mounting attach material packing, marked with product name, specification model, quantity, date in produced.

塑壳内包装为塑料袋，端子内包装为盘装带料包装，装（贴）入合格证，注明产品名称、规格型号、数量生产日期.

- (2) Exterior package is carton, facing the packing list, the packing list marked with product name, specification model, quantity, date of dispatch.

外包装为纸箱，贴装箱单，装箱单上注明产品名称、规格型号、数量、出货日期.

- (3) The product in the box must not rock.

产品在箱内不晃动.

9.2 Transportation (运输)

Allow for any way transportation, can't get wet and mechanical injury.

允许用任何方式运输，勿淋湿及机械性损伤.

9.3 Storage (贮存)

The connector of packing finished should be in the ambient temperature between -10°C to +40°C, relative humidity \leq 80%. To store in storehouse does not have acidic, alkaline air and other corrosive gas in the ambient air.

包装完毕的连接器应在环境温度 $-10^{\circ}\text{C}\sim+40^{\circ}\text{C}$ ，相对湿度 $\leq 80\%$ ，周围空气中没有酸性，碱性及其它腐蚀性气体的库房中贮存.

REV.	REVISION DESCRIPTION	DATE	APPD
	图面尺寸调整	3.31	刘兵

NOTES

Used in Y20004XXXX Series Housing.
 Accepts AWG #28~22 Wire Range.
 0.08 ~ 0.33 mm².
 Insulation 0. D.=0.9~1.5 mm.
 Material : Phosphor Bronze .
 Finish: Tin plated.
 Qty/Reel: 12,000 PCS.
 Thickness: 0.2 mm.

ORDERING INFORMATION

T 20004 X X X X

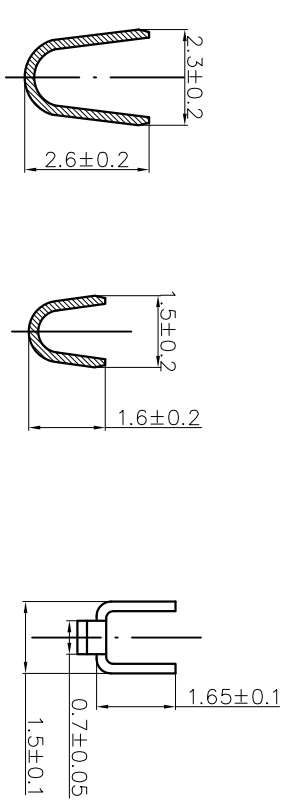
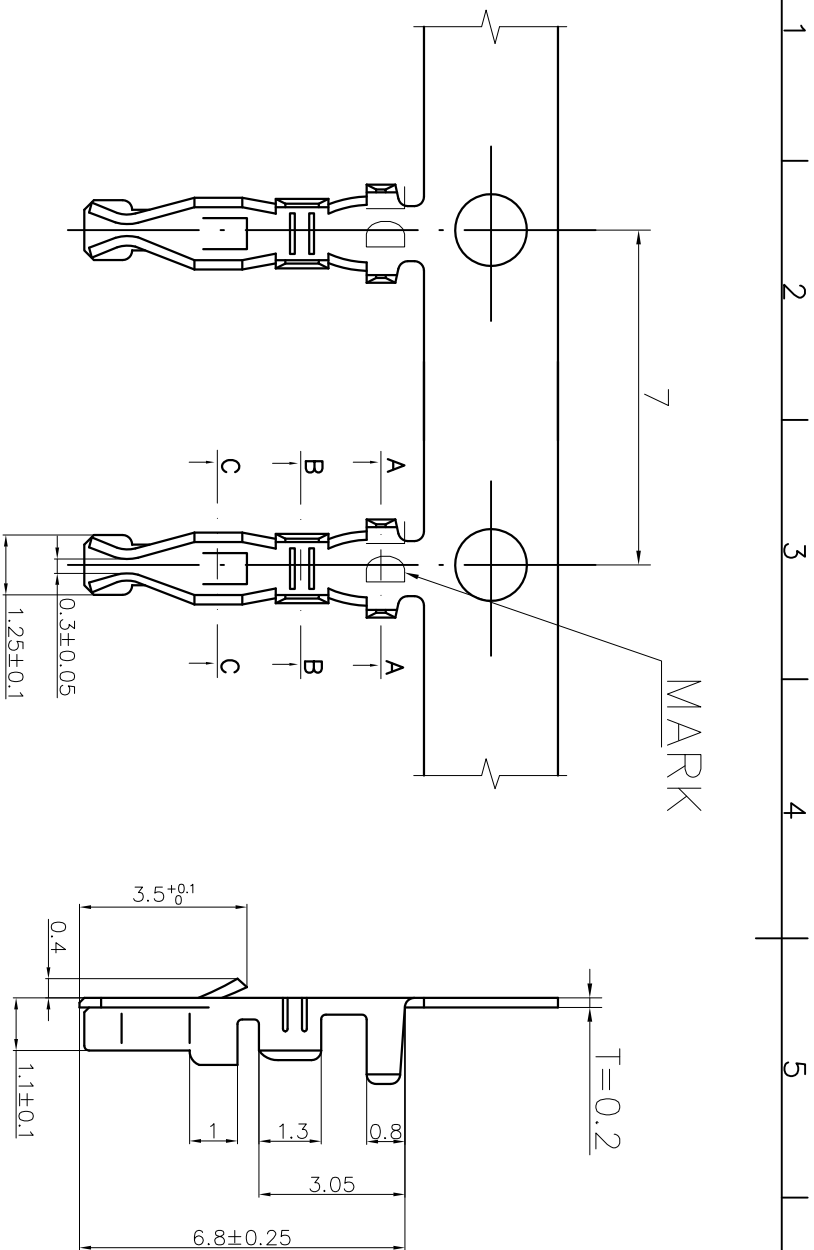
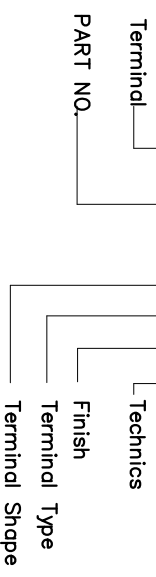

GENERAL TOLERANCES (UNLESS SPECIFIED)

.X: ± 0.25	X': ± 3.0'
.XX: ± 0.15	.X': ± 2.0'
.XXX: ± 0.01	.XX': ± 1.0'

ZHE JIANG DELU CONNECTORS CO.,LTD

PRODUCT NAME: PHD-T	TITLE: 2.00 mm Pitch Wire to Board Crimp
DR: Xiaodiang	DATE: 3.31
CHKD: Liu Bing	DATE: 3.31
APPD: An De	DATE: 3.31
DRAWING NO.: GC-T20004XXXX	PART NO: T20004XXXX
SCALE: N/A	PAGE: 1/1
UNITS: mm	REV: A

REV.	REVISION DESCRIPTION	DATE	APPD

RoHS compliant

NOTES

Available in 04 through 60 Circuits.
 Mates with A20004XXXX or D20004XXXX Series WAFER.
 Material : Nylon 66 UL94-V0(2).
 Accepts T20004XXXX Crimp Terminal.

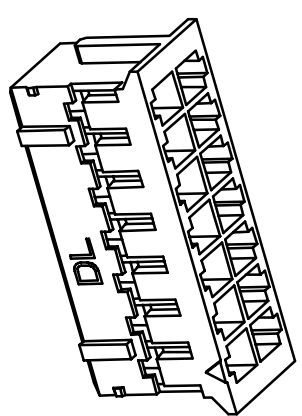
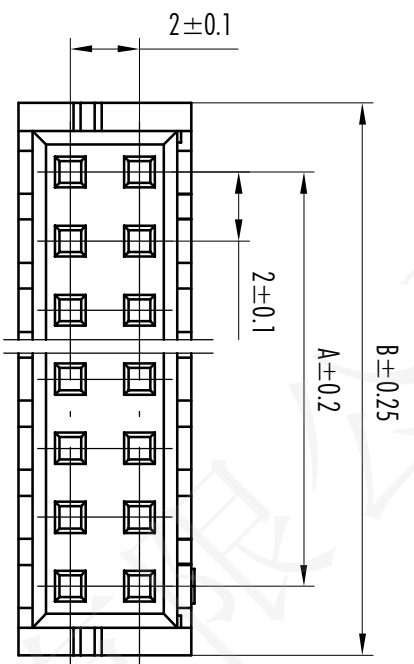

Circuit NO.1

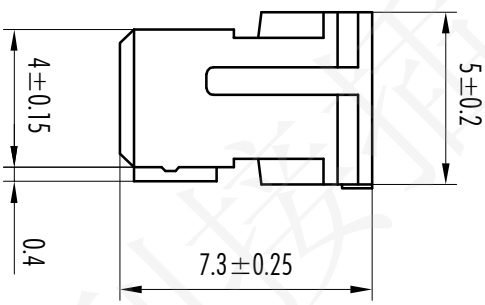
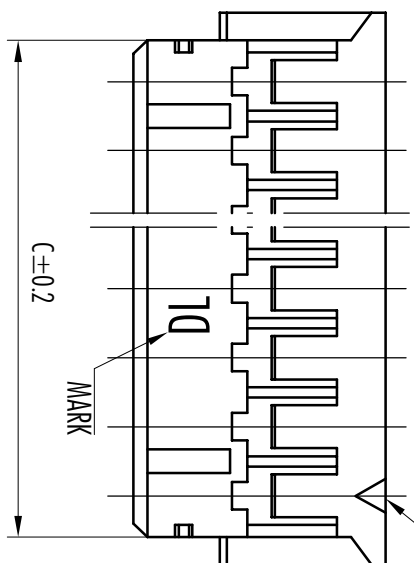

ORDERING INFORMATION

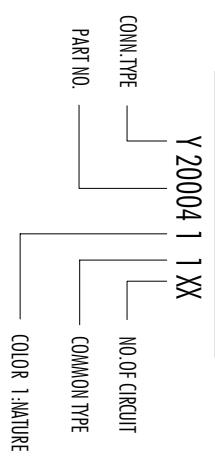

Circuits	Dimension mm			Circuits	Dimension mm			Circuits	Dimension mm		
	A	B	C		A	B	C		A	B	C
2X2	2.00	6.00	4.60	2X10	18.00	22.00	20.60	2X18	34.00	38.00	36.60
2X3	4.00	8.00	6.60	2X11	20.00	24.00	22.60	2X19	36.00	40.00	38.60
2X4	6.00	10.00	8.60	2X12	22.00	26.00	24.60	2X20	38.00	42.00	40.60
2X5	8.00	12.00	10.60	2X13	24.00	28.00	26.60	~	~	~	~
2X6	10.00	14.00	12.60	2X14	26.00	30.00	28.60	2X30	58.00	62.00	60.60
2X7	12.00	16.00	14.60	2X15	28.00	32.00	30.60				
2X8	14.00	18.00	16.60	2X16	30.00	34.00	32.60				
2X9	16.00	20.00	18.60	2X17	32.00	36.00	34.60				

GENERAL TOLERANCES (UNLESS SPECIFIED)

XX	±0.25	Y°	±3.0°
XX	±0.15	Y°	±2.0°
XXX	±0.01	XX°	±1.0°

ZHEJIANG DELI CONNECTORS CO., LTD

PRODUCT NAME	PHD-Y	TITLE	2.00 mm Pitch Wire To Board Housing
DR: Zhong Wen Jing	DATE: 09/08/01	PART NO.	Y20004XXXX
CHKD: Zhong Ren Chun	DATE: 09/08/01	SCALE: N/A	PAGE: 1/1
DRAWING NO: GC-Y20004XXX	APPD: Ren An De	DATE: 09/08/01	UNITS: mm
			REV.: A



REV.	REVISION DESCRIPTION	DATE	APPD

RoHS compliant

NOTES

Available in 04 through 60 Circuits.
 Mates with Y20006XXXX Series Housing.
 Material : Nylon 66 UL94-V0(2).
 0.50mm Square Pin.
 Pin Material : Brass / Tin-Plated.

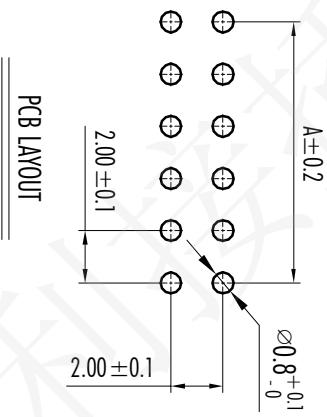
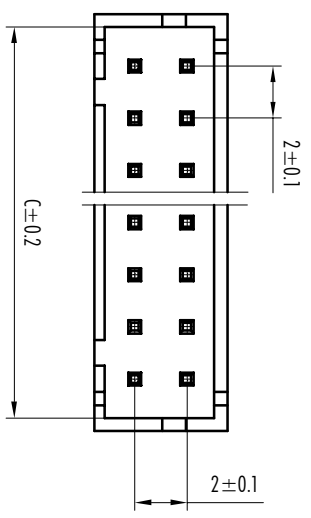
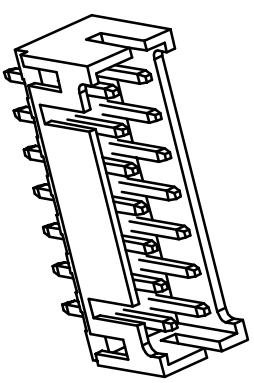
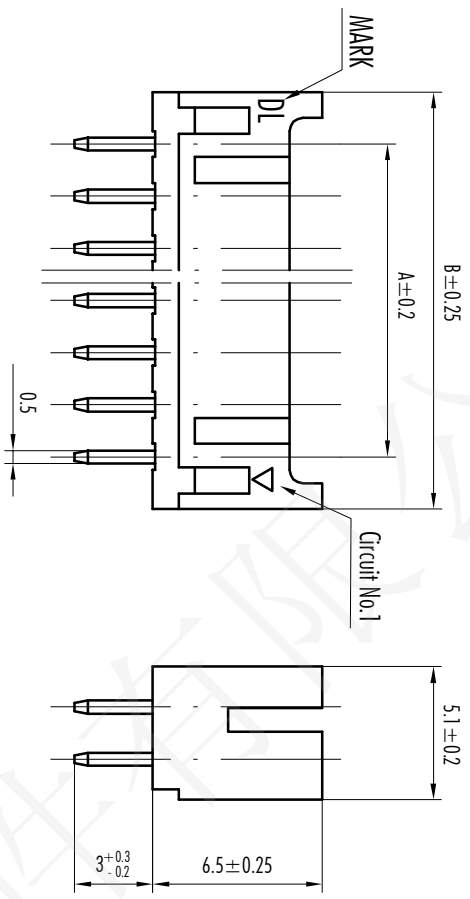

ORDERING INFORMATION

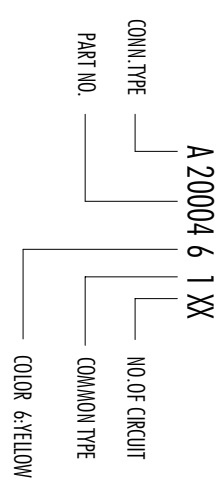

Circuits	Dimension mm			Circuits	Dimension mm			Circuits	Dimension mm		
	A	B	C		A	B	C		A	B	C
2X2	2.00	6.00	5.00	2X10	18.00	22.00	21.00	2X18	34.00	38.00	37.00
2X3	4.00	8.00	7.00	2X11	20.00	24.00	23.00	2X19	36.00	40.00	39.00
2X4	6.00	10.00	9.00	2X12	22.00	26.00	25.00	2X20	38.00	42.00	41.00
2X5	8.00	12.00	11.00	2X13	24.00	28.00	27.00	~	~	~	~
2X6	10.00	14.00	13.00	2X14	26.00	30.00	29.00	2X30	58.00	62.00	61.00
2X7	12.00	16.00	15.00	2X15	28.00	32.00	31.00				
2X8	14.00	18.00	17.00	2X16	30.00	34.00	33.00				
2X9	16.00	20.00	19.00	2X17	32.00	36.00	35.00				

GENERAL TOLERANCES (UNLESS SPECIFIED)

XX	±0.25	Y°	±3.0°
XX	±0.15	Y°	±2.0°
XX	±0.01	XX°	±1.0°

ZHE JIANG DELI CONNECTORS CO., LTD

PRODUCT NAME	PHD-A	TITLE	2.00 mm Pitch Wire To Board Wifer
DR: Zhong Wen Jing	DATE:09/08/01	PART NO:	A20004XXXX
CHKD: Zhong Ren Chun	DATE:09/08/01	SCALE: N/A	PAGE: 1/1
APPD:Ren An De	DATE:09/08/01	UNITS: mm	REV.: A



REV.	REVISION DESCRIPTION	DATE

RoHS compliant

NOTES

Available in 04 through 60 Circuits.
 Mates with Y20006XXXX Series Housing.
 Material : Nylon 66 UL94-V0(2).
 0.50mm Square Pin.
 Pin Material : Brass / Tin-Plated.

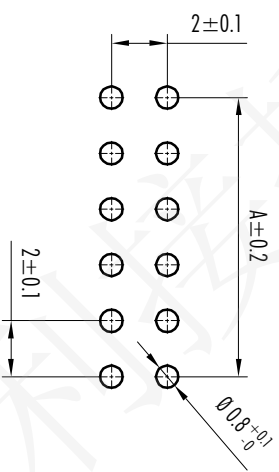
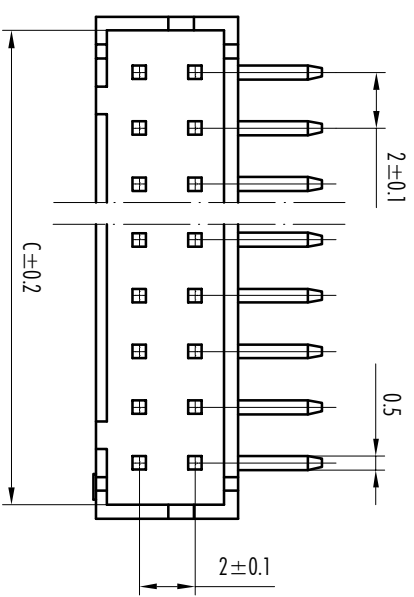
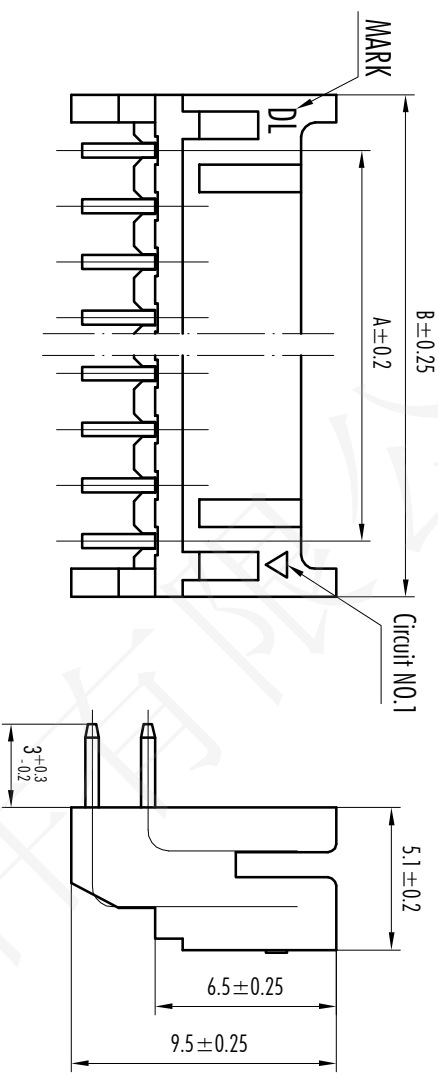
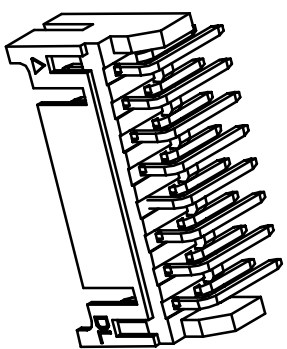

PCB LAYOUT

Circuits	Dimension mm			Circuits	Dimension mm			Circuits	Dimension mm		
	A	B	C		A	B	C		A	B	C
2X2	2.00	6.00	5.00	2X10	18.00	22.00	21.00	2X18	34.00	38.00	37.00
2X3	4.00	8.00	7.00	2X11	20.00	24.00	23.00	2X19	36.00	40.00	39.00
2X4	6.00	10.00	9.00	2X12	22.00	26.00	25.00	2X20	38.00	42.00	41.00
2X5	8.00	12.00	11.00	2X13	24.00	28.00	27.00	~	~	~	~
2X6	10.00	14.00	13.00	2X14	26.00	30.00	29.00	2X30	58.00	62.00	61.00
2X7	12.00	16.00	15.00	2X15	28.00	32.00	31.00				
2X8	14.00	18.00	17.00	2X16	30.00	34.00	33.00				
2X9	16.00	20.00	19.00	2X17	32.00	36.00	35.00				



ORDERING INFORMATION

D 20004 6 1 XX

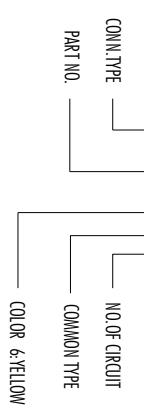

GENERAL TOLERANCES (UNLESS SPECIFIED)

XX	±0.25	XX	±3.0°
XX	±0.15	XX	±2.0°
XXX	±0.01	XX	±1.0°

ZHEJIANG DELI CONNECTORS CO., LTD

PRODUCT NAME	PHD-AWD	TITLE	2.0 mm Pitch Wire To Board Wlder
DR: Zhong Wen Jing	DATE: 09/08/01	PART NO:	D2000461XX
CHKD: Zhong Ren Chun	DATE: 09/08/01	SCALE: N/A	PAGE: 1/1
APP: Ren An De	DATE: 09/08/01	UNITS: mm	REV.: A
DRAWING NO: GC-D2000461XX			

F

E

D

C

B

A

1 2 3 4 5 6 7 8