

● ELECTRICAL PARAMETERS

谐振器产品技术指标		Min	Max	Units
1. Holder Type(型号规格)		SEAM 49S		
2. Mode of Oscillation (振动模式)		Fundamental		
3. Frequency (标称频率)		27.141200		MHz
4. Load Capacitance (CL) (负载电容)		20		pF
5. Drive Level (激励功率)		100		uw
6. Equivalent Resistance (谐振电阻)			40	Ω
7. Shunt Capacitance (Co) (静态电容)		0	7	pF
8. Motional Capacitance (C1) (动态电容)		N/A		fF
9. Frequency Tolerance at 25°C (调整频差)		-20	20	ppm
10. Stability over operation temperature (温度频差)		± 30		ppm
11. Insulation Resistance (at DC 100V) (绝缘电阻)		500		MΩ
12. Operating Temperature Range (工作温度范围)		-20	70	°C
13. Storage Temperature Range (储存温度范围)		-30	85	°C
14. Aging (老化率)		± 5		ppm/year
15. DLD2	N/A		N/A	Ω
16. FLD2			N/A	ppm
17. RLD2			N/A	Ω
18. SPDB			N/A	db
19. Other(其它)		N/A		

OUTLINE DIMENSIONS(UNIT:mm) 外形尺寸 (单位: mm)

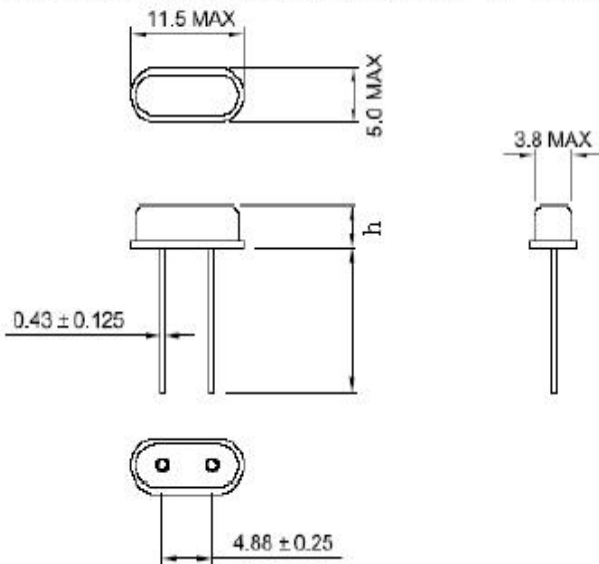

Units:mm

h:	3.3±0.30
H:	13.2±0.5

联络方式: 电邮: taesz@163.com 移动: 138-0255-9153 联络人: 李先生