

## Dual N-Ch 40V Fast Switching MOSFETs

### Description

The HSM4204 is the high cell density trenched N-ch MOSFETs, which provide excellent R<sub>DS(ON)</sub> and gate charge for most of the synchronous buck converter applications.

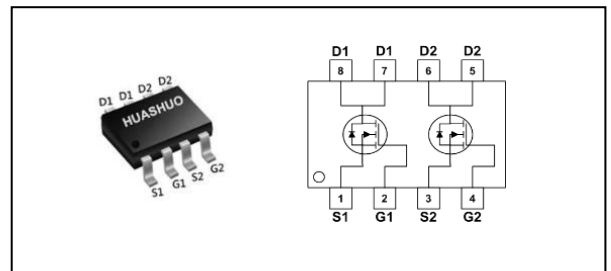
The HSM4204 meet the RoHS and Green Product requirement, 100% EAS guaranteed with full function reliability approved.

- 100% EAS Guaranteed
- Green Device Available
- Super Low Gate Charge
- Excellent CdV/dt effect decline
- Advanced high cell density Trench technology

### Product Summary

V <sub>DS</sub>	40	V
R <sub>DS(ON),typ</sub>	12	mΩ
I <sub>D</sub>	7.5	A

### SOP8 Pin Configuration



### Absolute Maximum Ratings

Symbol	Parameter	Rating	Units
V <sub>DS</sub>	Drain-Source Voltage	40	V
V <sub>GS</sub>	Gate-Source Voltage	±20	V
I <sub>D</sub> @T <sub>A</sub> =25°C	Continuous Drain Current, V <sub>GS</sub> @ 10V <sub>1</sub>	7.5	A
I <sub>D</sub> @T <sub>A</sub> =70°C	Continuous Drain Current, V <sub>GS</sub> @ 10V <sub>1</sub>	6	A
I <sub>DM</sub>	Pulsed Drain Current <sub>2</sub>	30	A
EAS	Single Pulse Avalanche Energy <sub>3</sub>	31	mJ
I <sub>AS</sub>	Avalanche Current	25	A
P <sub>D</sub> @T <sub>A</sub> =25°C	Total Power Dissipation <sub>4</sub>	1.5	W
T <sub>STG</sub>	Storage Temperature Range	-55 to 150	°C
T <sub>J</sub>	Operating Junction Temperature Range	-55 to 150	°C

### Thermal Data

Symbol	Parameter	Typ.	Max.	Unit
R <sub>θJA</sub>	Thermal Resistance Junction-ambient (Steady State) <sub>1</sub>	---	85	°C/W
R <sub>θJC</sub>	Thermal Resistance Junction-Case <sub>1</sub>	---	36	°C/W



**Dual N-Ch 40V Fast Switching MOSFETs**

**Electrical Characteristics (T<sub>J</sub>=25 °C, unless otherwise noted)**

Symbol	Parameter	Conditions	Min.	Typ.	Max.	Unit
BV <sub>DSS</sub>	Drain-Source Breakdown Voltage	V <sub>GS</sub> =0V, I <sub>D</sub> =250uA	40	---	---	V
ΔBV <sub>DSS</sub> /ΔT <sub>J</sub>	BVDSS Temperature Coefficient	Reference to 25°C, I <sub>D</sub> =1mA	---	0.034	---	V/°C
R <sub>DS(ON)</sub>	Static Drain-Source On-Resistance <sup>2</sup>	V <sub>GS</sub> =10V, I <sub>D</sub> =6A	---	12	15	mΩ
		V <sub>GS</sub> =4.5V, I <sub>D</sub> =3A	---	17	20	
V <sub>GS(th)</sub>	Gate Threshold Voltage	V <sub>GS</sub> =V <sub>DS</sub> , I <sub>D</sub> =250uA	1.0	---	2.5	V
ΔV <sub>GS(th)</sub>	V <sub>GS(th)</sub> Temperature Coefficient		---	-5.64	---	mV/°C
I <sub>DSS</sub>	Drain-Source Leakage Current	V <sub>DS</sub> =32V, V <sub>GS</sub> =0V, T <sub>J</sub> =25°C	---	---	1	uA
		V <sub>DS</sub> =32V, V <sub>GS</sub> =0V, T <sub>J</sub> =55°C	---	---	5	
I <sub>GSS</sub>	Gate-Source Leakage Current	V <sub>GS</sub> =±20V, V <sub>DS</sub> =0V	---	---	±100	nA
g <sub>fs</sub>	Forward Transconductance	V <sub>DS</sub> =5V, I <sub>D</sub> =6A	---	31	---	S
R <sub>g</sub>	Gate Resistance	V <sub>DS</sub> =0V, V <sub>GS</sub> =0V, f=1MHz	---	2.1	---	Ω
Q <sub>g</sub>	Total Gate Charge (4.5V)	V <sub>DS</sub> =20V, V <sub>GS</sub> =4.5V, I <sub>D</sub> =6A	---	10.7	---	nC
Q <sub>gs</sub>	Gate-Source Charge		---	3.3	---	
Q <sub>gd</sub>	Gate-Drain Charge		---	4.2	---	
T <sub>d(on)</sub>	Turn-On Delay Time	V <sub>DD</sub> =12V, V <sub>GS</sub> =10V, R <sub>G</sub> =3.3Ω I <sub>D</sub> =6A	---	8.6	---	ns
T <sub>r</sub>	Rise Time		---	3.4	---	
T <sub>d(off)</sub>	Turn-Off Delay Time		---	25	---	
T <sub>f</sub>	Fall Time		---	2.2	---	
C <sub>iss</sub>	Input Capacitance	V <sub>DS</sub> =15V, V <sub>GS</sub> =0V, f=1MHz	---	1314	---	pF
C <sub>oss</sub>	Output Capacitance		---	120	---	
C <sub>rss</sub>	Reverse Transfer Capacitance		---	88	---	

**Diode Characteristics**

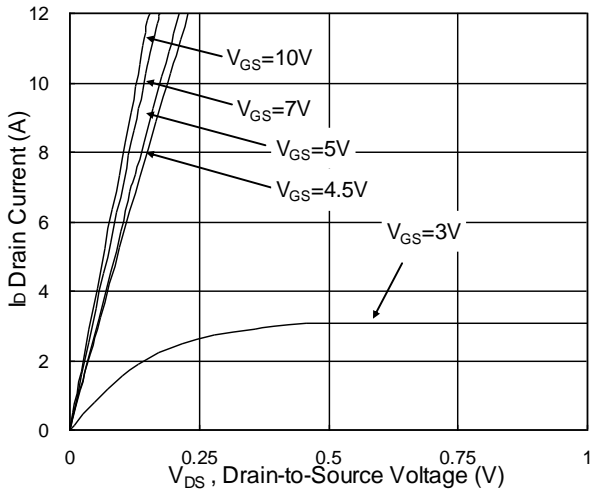
Symbol	Parameter	Conditions	Min.	Typ.	Max.	Unit
I <sub>S</sub>	Continuous Source Current <sup>1,5</sup>	V <sub>G</sub> =V <sub>D</sub> =0V, Force Current	---	---	7.5	A
I <sub>SM</sub>	Pulsed Source Current <sup>2,5</sup>		---	---	30	A
V <sub>SD</sub>	Diode Forward Voltage <sup>2</sup>	V <sub>GS</sub> =0V, I <sub>S</sub> =1A, T <sub>J</sub> =25°C	---	---	1.2	V

Note :

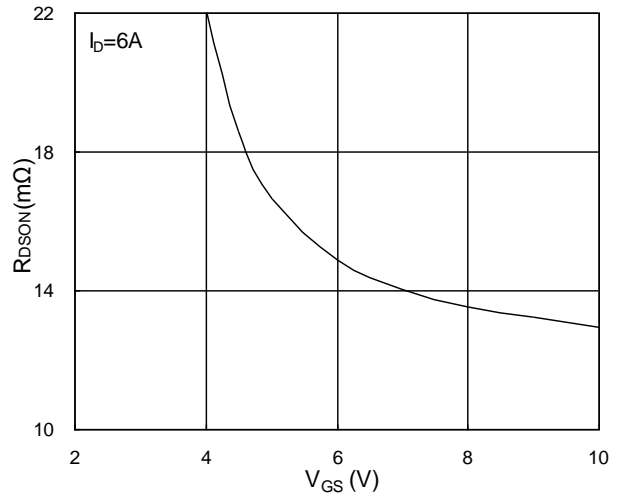
- 1.The data tested by surface mounted on a 1 inch<sup>2</sup> FR-4 board with 2OZ copper.
- 2.The data tested by pulsed , pulse width ≤ 300us , duty cycle ≤ 2%
- 3.The EAS data shows Max. rating . The test condition is V<sub>DD</sub>=25V,V<sub>GS</sub>=10V,L=0.1mH,I<sub>AS</sub>=25A
- 4.The power dissipation is limited by 175°C junction temperature
- 5.The data is theoretically the same as I<sub>D</sub> and I<sub>DM</sub> , in real applications , should be limited by total power dissipation.

## Dual N-Ch 40V Fast Switching MOSFETs

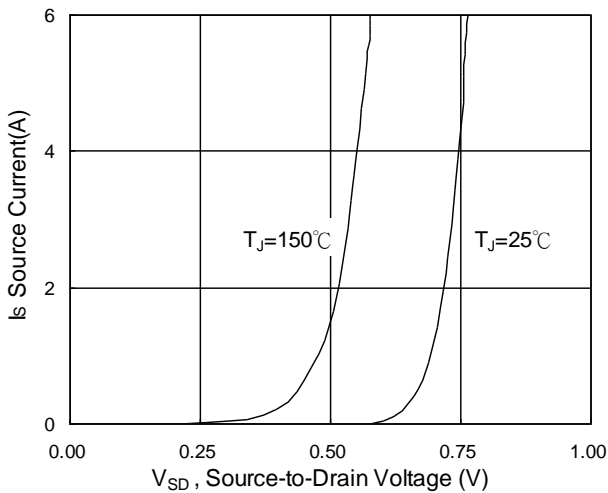
### Typical Characteristics



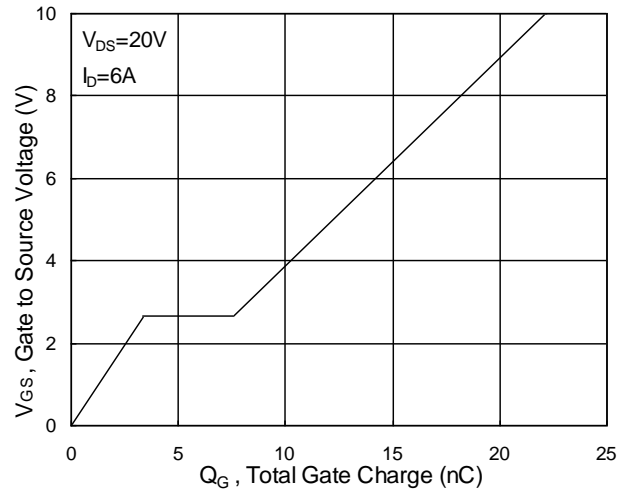
**Fig.1 Typical Output Characteristics**



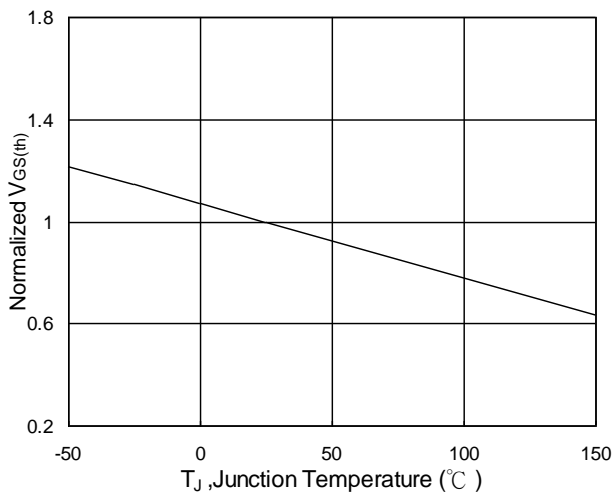
**Fig.2 On-Resistance vs. G-S Voltage**



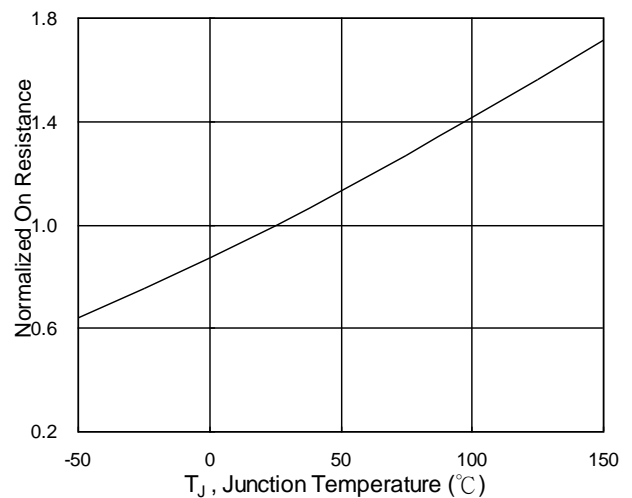
**Fig.3 Forward Characteristics of Reverse**



**Fig.4 Gate-Charge Characteristics**

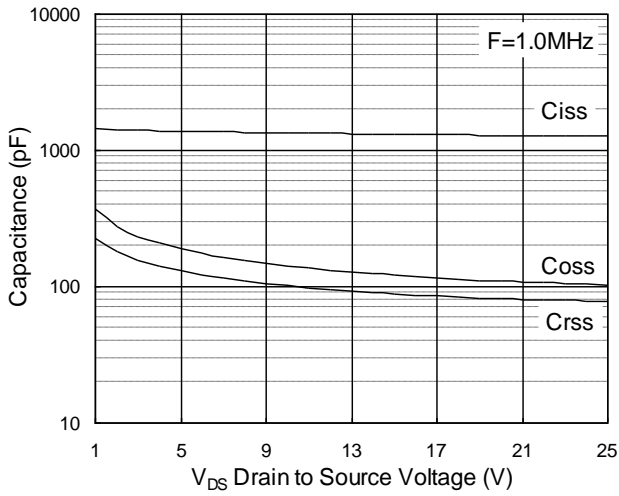


**Fig.5 Normalized  $V_{GS(th)}$  vs.  $T_J$**

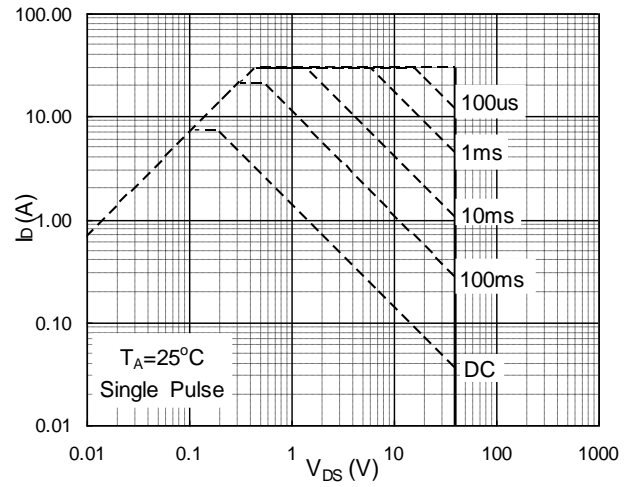


**Fig.6 Normalized  $R_{DS(on)}$  vs.  $T_J$**

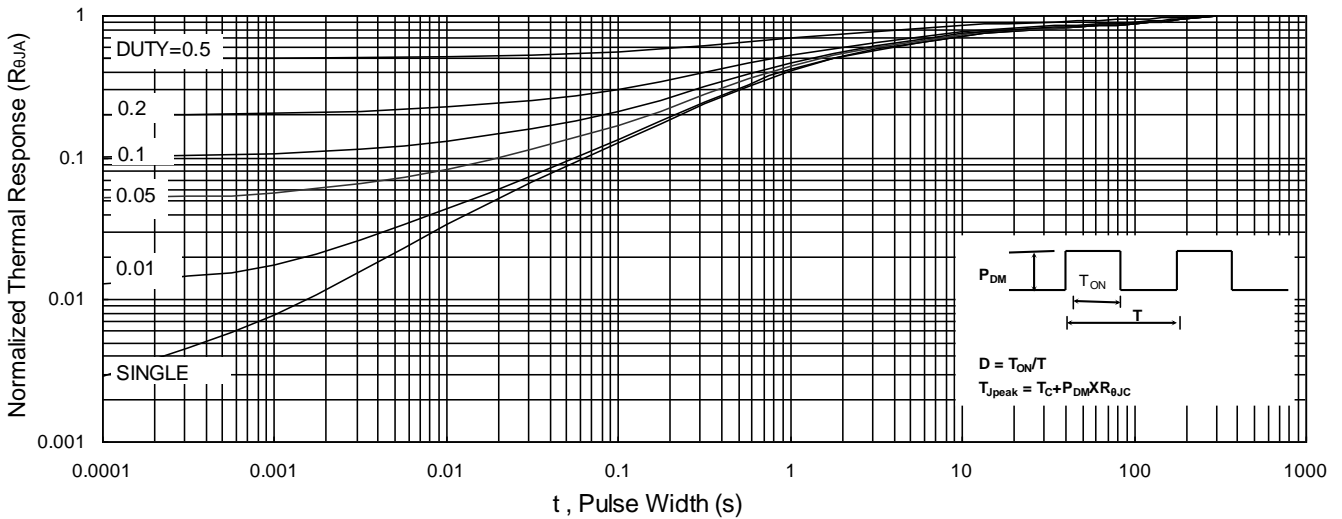
## Dual N-Ch 40V Fast Switching MOSFETs



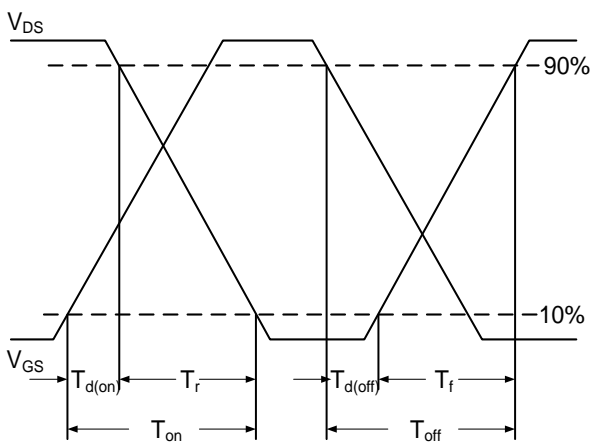
**Fig.7 Capacitance**



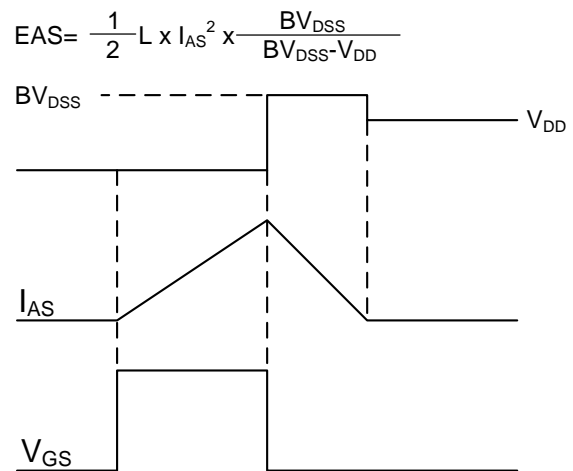
**Fig.8 Safe Operating Area**



**Fig.9 Normalized Maximum Transient Thermal Impedance**



**Fig.10 Switching Time Waveform**



**Fig.11 Unclamped Inductive Switching**

## Ordering Information

Part Number	Package code	Packaging
HSM4204	SOP-8	2500/Tape&Reel

