

N-Ch and P-Ch Fast Switching MOSFETs

Description

The HSM2903 is the high performance complementary N-ch and P-ch MOSFETs with high cell density, which provide excellent RDSON and gate charge for most of the synchronous buck converter applications.

The HSM2903 meet the RoHS and Green Product requirement 100% EAS guaranteed with full function reliability approved.

- 100% EAS Guaranteed
- Green Device Available
- Super Low Gate Charge
- Excellent CdV/dt effect decline
- Advanced high cell density Trench technology

Product Summary

BVDSS	RDSON	ID
20V	14mΩ	10A
-20V	45mΩ	-6.5A

SOP8 Pin Configuration

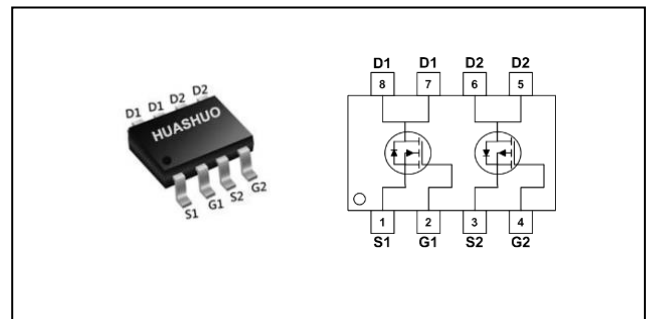

Absolute Maximum Ratings

Symbol	Parameter	Rating		Units
		N-Ch	P-Ch	
V _{DS}	Drain-Source Voltage	20	-20	V
V _{GS}	Gate-Source Voltage	±20	±20	V
I _D @T _A =25°C	Continuous Drain Current, V _{GS} @ 10V ₁	10	-6.5	A
I _D @T _A =70°C	Continuous Drain Current, V _{GS} @ 10V ₁	8	-5.2	A
I _{DM}	Pulsed Drain Current ₂	40	-32	A
EAS	Single Pulse Avalanche Energy ₃	24	50	mJ
P _D @T _A =25°C	Total Power Dissipation ₄	1.5	1.5	W
T _{STG}	Storage Temperature Range	-55 to 150	-55 to 150	°C
T _J	Operating Junction Temperature Range	-55 to 150	-55 to 150	°C

Thermal Data

Symbol	Parameter	Typ.	Max.	Unit
R _{θJA}	Thermal Resistance Junction-Ambient ₁	---	85	°C/W
R _{θJC}	Thermal Resistance Junction-Case ₁	---	25	°C/W



N-Ch and P-Ch Fast Switching MOSFETs

N-Channel Electrical Characteristics (T_J=25 °C, unless otherwise noted)

Symbol	Parameter	Conditions	Min.	Typ.	Max.	Unit
BV _{DSS}	Drain-Source Breakdown Voltage	V _{GS} =0V , I _D =250uA	20	---	---	V
ΔBV _{DSS} /ΔT _J	BVDSS Temperature Coefficient	Reference to 25°C , I _D =1mA	---	0.023	---	V/°C
R _{DS(ON)}	Static Drain-Source On-Resistance ₂	V _{GS} =4.5V , I _D =4A	---	---	14	mΩ
		V _{GS} =2.5V , I _D =3A	---	---	18	
V _{GS(th)}	Gate Threshold Voltage	V _{GS} =V _{DS} , I _D =250uA	0.5	---	1.0	V
ΔV _{GS(th)}	V _{GS(th)} Temperature Coefficient		---	-5.08	---	mV/°C
I _{DSS}	Drain-Source Leakage Current	V _{DS} =16V , V _{GS} =0V , T _J =25°C	---	---	1	uA
		V _{DS} =16V , V _{GS} =0V , T _J =55°C	---	---	5	
I _{GSS}	Gate-Source Leakage Current	V _{GS} =±12V , V _{DS} =0V	---	---	±100	nA
g _{fs}	Forward Transconductance	V _{DS} =5V , I _D =4A	---	24	---	S
Q _g	Total Gate Charge (4.5V)	V _{DS} =15V , V _{GS} =4.5V , I _D =4A	---	11	---	nC
Q _{gs}	Gate-Source Charge		---	1.2	---	
Q _{gd}	Gate-Drain Charge		---	4.2	---	
T _{d(on)}	Turn-On Delay Time	V _{DD} =10V , V _{GS} =4.5V , R _G =3.3Ω I _D =4A	---	5.2	---	ns
T _r	Rise Time		---	34	---	
T _{d(off)}	Turn-Off Delay Time		---	23	---	
T _f	Fall Time		---	9.2	---	
C _{iss}	Input Capacitance	V _{DS} =15V , V _{GS} =0V , f=1MHz	---	750	---	pF
C _{oss}	Output Capacitance		---	85	---	
C _{rss}	Reverse Transfer Capacitance		---	73	---	

Diode Characteristics

Symbol	Parameter	Conditions	Min.	Typ.	Max.	Unit
I _S	Continuous Source Current _{1,5}	V _G =V _D =0V , Force Current	---	---	10	A
I _{SM}	Pulsed Source Current _{2,5}		---	---	40	A
V _{SD}	Diode Forward Voltage ₂	V _{GS} =0V , I _S =1A , T _J =25°C	---	---	1	V

Note :

- 1.The data tested by surface mounted on a 1 inch² FR-4 board with 2OZ copper.
- 2.The data tested by pulsed , pulse width ≤ 300us , duty cycle ≤ 2%
- 3.The power dissipation is limited by 150°C junction temperature
- 4.The data is theoretically the same as I_D and I_{DM} , in real applications , should be limited by total power dissipation.



P-Channel Electrical Characteristics (T_J=25 °C, unless otherwise noted)

Symbol	Parameter	Conditions	Min.	Typ.	Max.	Unit
B _{VDS}	Drain-Source Breakdown Voltage	V _{GS} =0V, I _D =-250uA	-20	---	---	V
ΔB _{VDS} /ΔT _J	B _{VDS} Temperature Coefficient	Reference to 25°C, I _D =-1mA	---	-0.022	---	V/°C
R _{DS(ON)}	Static Drain-Source On-Resistance ²	V _{GS} =-4.5V, I _D =-4.9A	---	40	45	mΩ
		V _{GS} =-2.5V, I _D =-3.4A	---	50	60	
V _{GS(th)}	Gate Threshold Voltage	V _{GS} =V _{DS} , I _D =-250uA	-0.4	---	-1.0	V
ΔV _{GS(th)}	V _{GS(th)} Temperature Coefficient		---	4.6	---	mV/°C
I _{DSS}	Drain-Source Leakage Current	V _{DS} =-16V, V _{GS} =0V, T _J =25°C	---	---	-1	uA
		V _{DS} =-16V, V _{GS} =0V, T _J =55°C	---	---	-5	
I _{GSS}	Gate-Source Leakage Current	V _{GS} =±12V, V _{DS} =0V	---	---	±100	nA
g _{fs}	Forward Transconductance	V _{DS} =-5V, I _D =-3A	---	13	---	S
Q _g	Total Gate Charge (-4.5V)	V _{DS} =-15V, V _{GS} =-4.5V, I _D =-3A	---	10	---	nC
Q _{gs}	Gate-Source Charge		---	1.89	---	
Q _{gd}	Gate-Drain Charge		---	3.1	---	
T _{d(on)}	Turn-On Delay Time	V _{DD} =-10V, V _{GS} =-4.5V, R _G =3.3Ω, I _D =-3A	---	5.6	---	ns
T _r	Rise Time		---	41	---	
T _{d(off)}	Turn-Off Delay Time		---	33	---	
T _f	Fall Time		---	18	---	
C _{iss}	Input Capacitance	V _{DS} =-15V, V _{GS} =0V, f=1MHz	---	857	---	pF
C _{oss}	Output Capacitance		---	114	---	
C _{rss}	Reverse Transfer Capacitance		---	108	---	

Diode Characteristics

Symbol	Parameter	Conditions	Min.	Typ.	Max.	Unit
I _S	Continuous Source Current ^{1,5}	V _G =V _D =0V, Force Current	---	---	-6.5	A
I _{SM}	Pulsed Source Current ^{2,5}		---	---	-32	A
V _{SD}	Diode Forward Voltage ²	V _{GS} =0V, I _S =-1A, T _J =25°C	---	---	-1	V

Note :

- 1.The data tested by surface mounted on a 1 inch² FR-4 board with 2OZ copper.
- 2.The data tested by pulsed , pulse width ≤ 300us , duty cycle ≤ 2%
- 3.The power dissipation is limited by 150°C junction temperature
- 4.The data is theoretically the same as I_D and I_{DM} , in real applications , should be limited by total power dissipation.



N-Ch and P-Ch Fast Switching MOSFETs

N-Channel Typical Characteristics

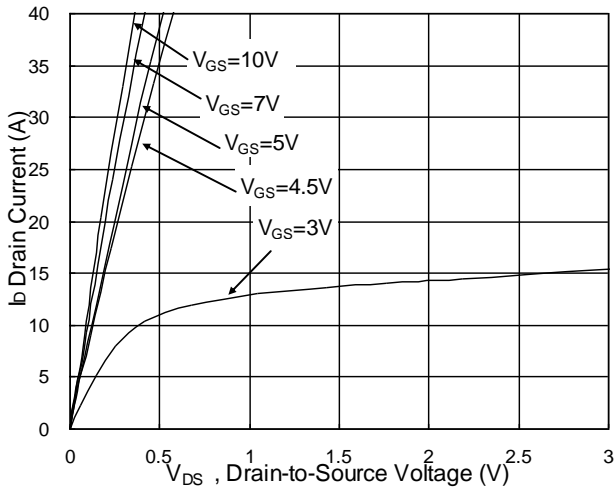

Fig.1 Typical Output Characteristics

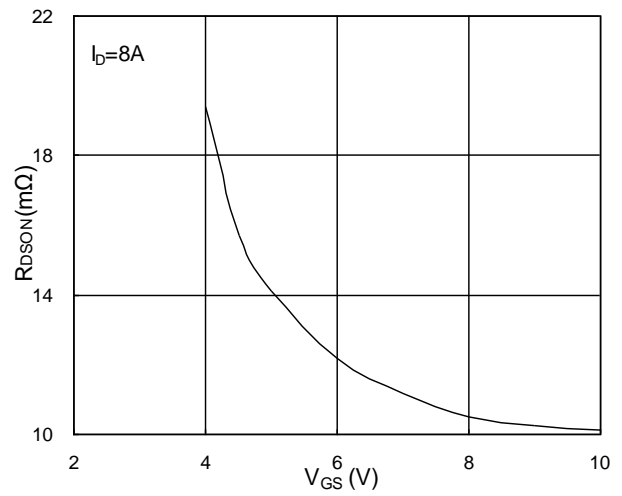

Fig.2 On-Resistance vs. G-S Voltage

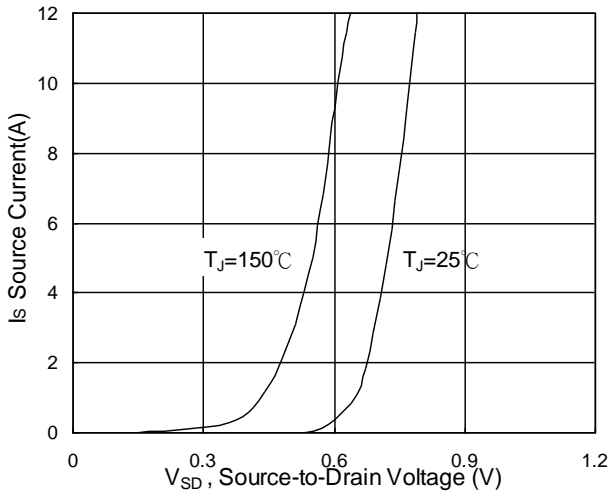

Fig.3 Forward Characteristics of Reverse

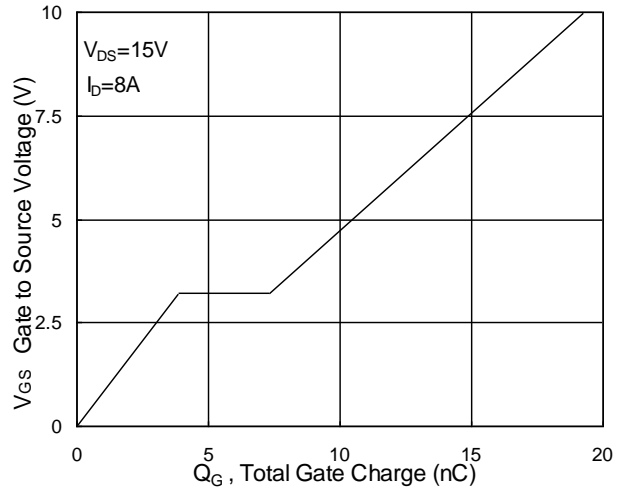

Fig.4 Gate-Charge Characteristics

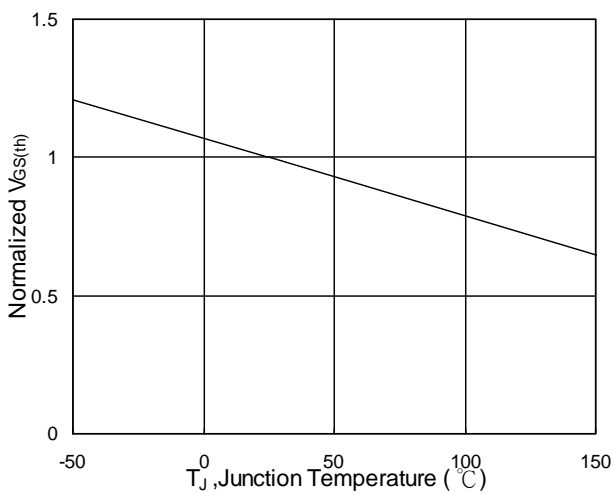

Fig.5 Normalized V_{GS(th)} vs. T_J

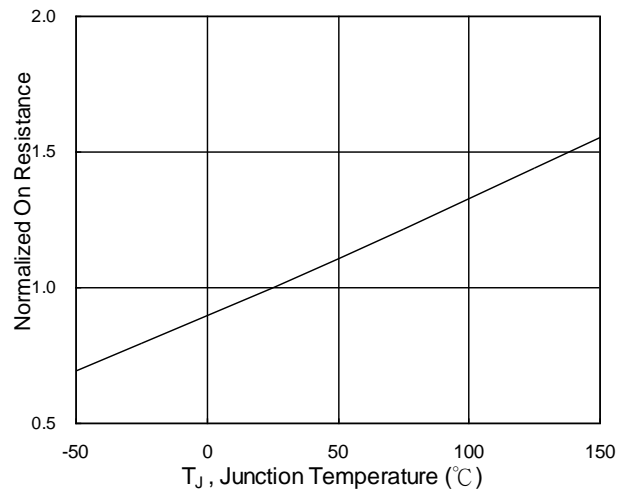

Fig.6 Normalized R_{DS(on)} vs. T_J



N-Ch and P-Ch Fast Switching MOSFETs

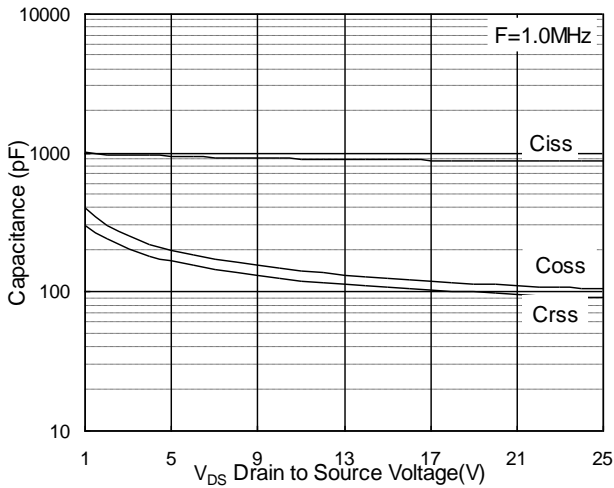

Fig.7 Capacitance

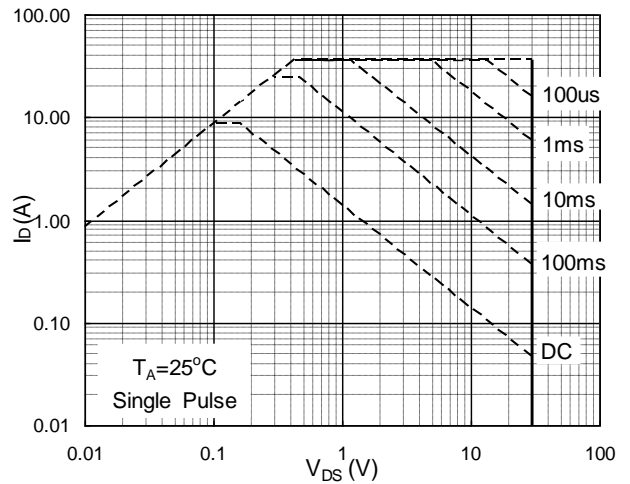

Fig.8 Safe Operating Area

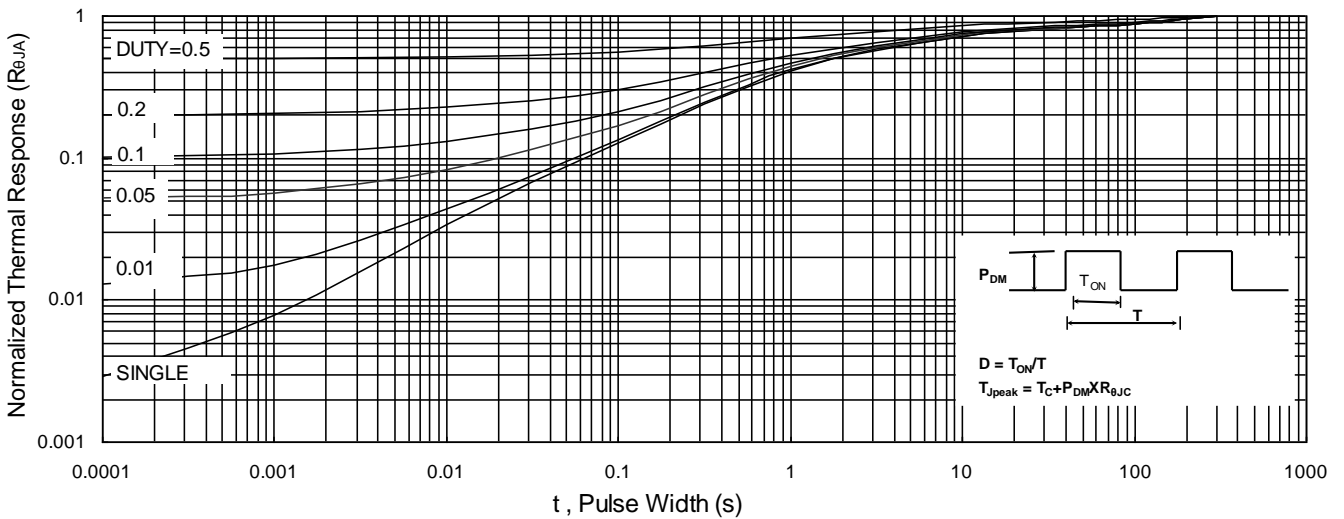

Fig.9 Normalized Maximum Transient Thermal Impedance

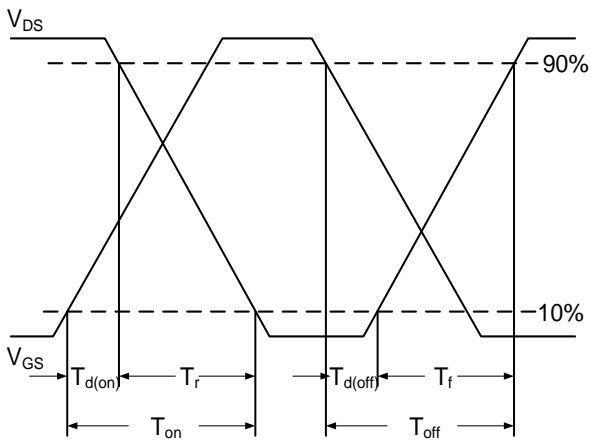

Fig.10 Switching Time Waveform

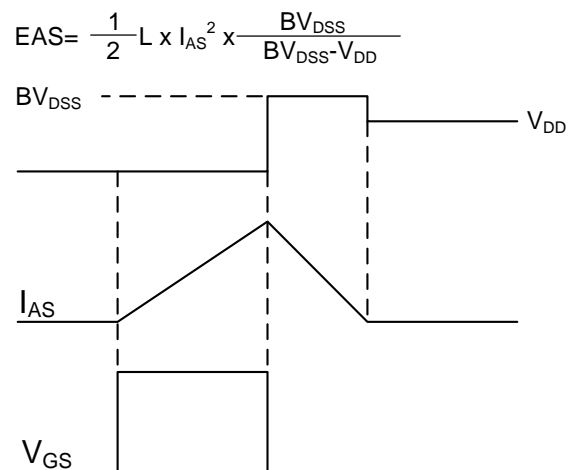

Fig.11 Unclamped Inductive Switching Waveform



N-Ch and P-Ch Fast Switching MOSFETs

P-Channel Typical Characteristics

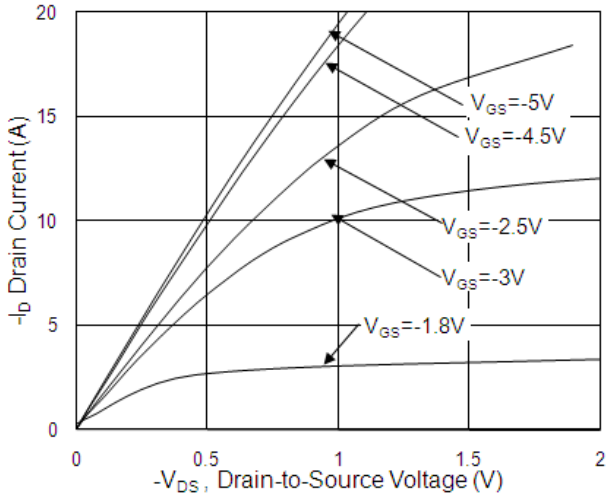

Fig.1 Typical Output Characteristics

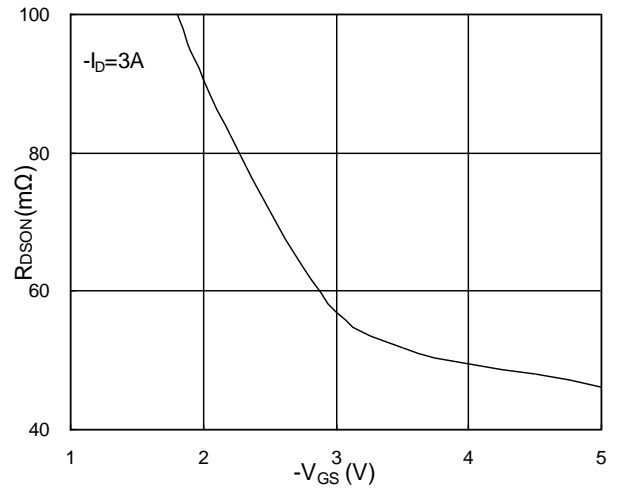

Fig.2 On-Resistance v.s Gate-Source

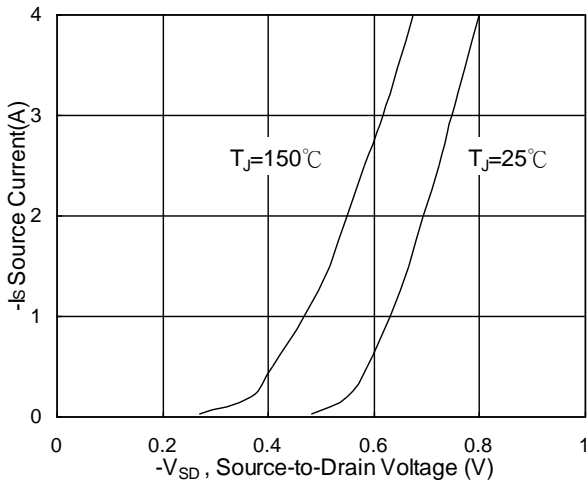

Fig.3 Forward Characteristics of Reverse

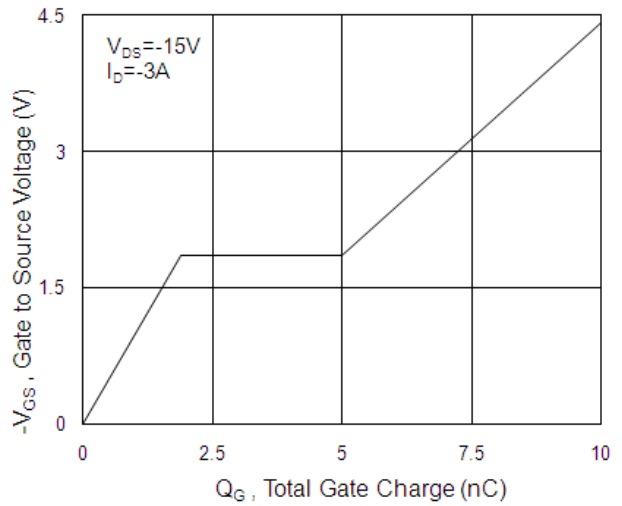

Fig.4 Gate-Charge Characteristics

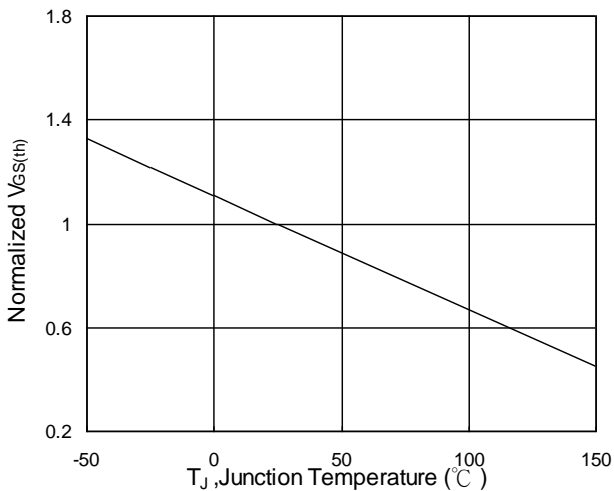

Fig.5 Normalized $V_{GS(th)}$ v.s T_J

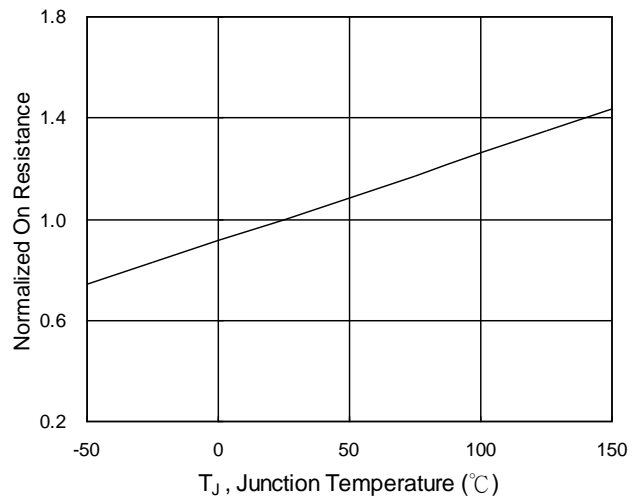

Fig.6 Normalized $R_{DS(on)}$ v.s T_J



N-Ch and P-Ch Fast Switching MOSFETs

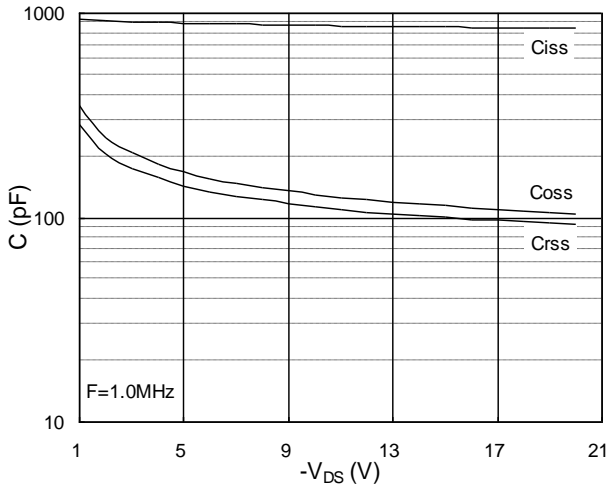

Fig.7 Capacitance

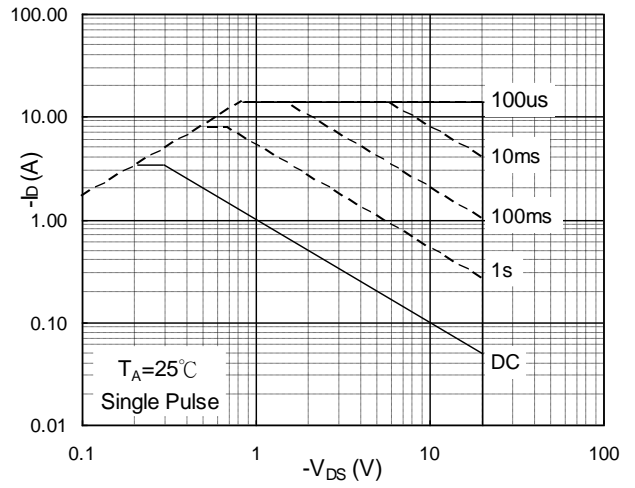

Fig.8 Safe Operating Area

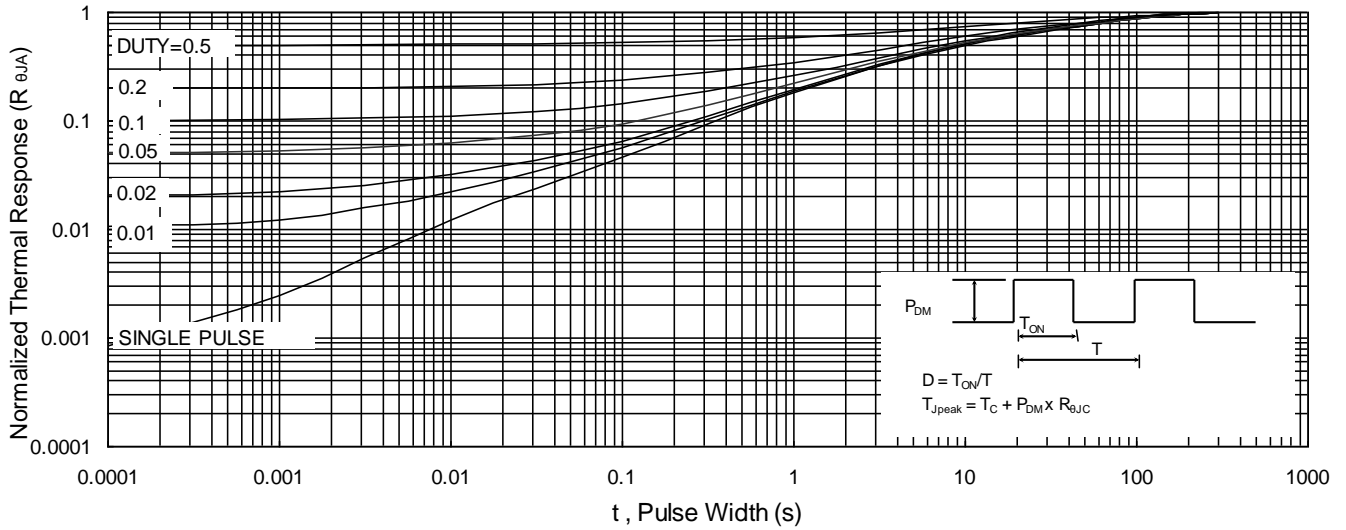

Fig.9 Normalized Maximum Transient Thermal Impedance

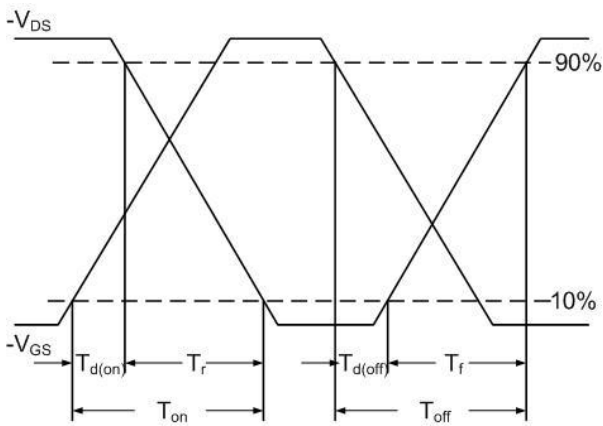

Fig.10 Switching Time Waveform

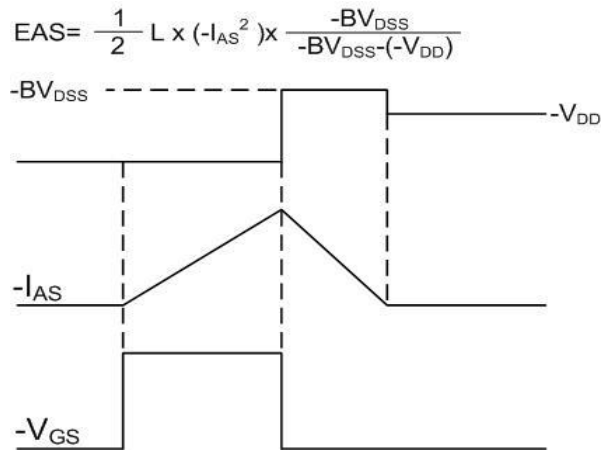

Fig.11 Unclamped Inductive Switching



Ordering Information

Part Number	Package code	Packaging
HSM2903	SOP-8	4000/Tape&Reel

