

Features

- Load Switch for Portable Devices
- DC/DC Converter
- Epoxy Meets UL 94 V-0 Flammability Rating
- Moisture Sensitivity Level 1
- Halogen Free Available Upon Request By Adding Suffix "-HF"
- Lead Free Finish/RoHS Compliant ("P" Suffix Designates RoHS Compliant. See Ordering Information)

Maximum Ratings

- Operating Junction Temperature Range: -55°C to +150°C
- Storage Temperature: -55°C to +150°C
- Thermal Resistance: 120°C/W Junction to Ambient^(Note 1)

Parameter	Symbol	Rating	Unit
Drain -source Voltage	V_{DS}	-20	V
Gate -Source Voltage	V_{GS}	± 8	V
Continuous Drain Current	I_D	-8.2	A
Continuous Source-Drain Diode Current	I_S	-0.95	A
Total Power Dissipation	P_D	1.05	W

Internal Structure

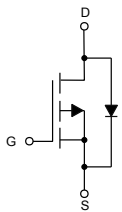

Pin1&5&8----Drain
Pin2&3&6&7----Source
Pin4----Gate

Marking: S5_B

P-Channel MOSFET

TSSOP-8

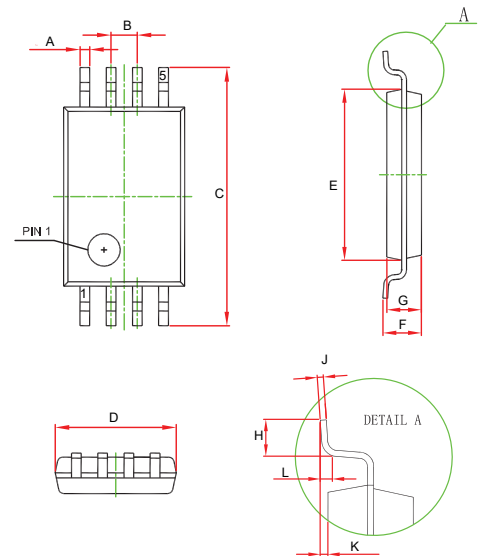

DIM	INCHES		MM		NOTE
	MIN	MAX	MIN	MAX	
A	0.007	.011	0.170	0.270	
B	0.026BSC.		0.650BSC.		
C	0.244	0.260	6.200	6.600	
D	0.112	0.120	2.850	3.050	
E	0.169	0.177	4.300	4.500	
F	0.039	0.047	1.000	1.200	
G	0.035	0.043	0.900	1.100	
H	0.016	0.031	0.400	0.800	
J	0.003	0.008	0.077	0.200	
K	0.001	0.007	0.020	0.180	
L	0.010TYP.		0.250TYP.		

ELECTRICAL CHARACTERISTICS (Ta=25°C unless otherwise specified)

Parameter	Symbol	Test conditions	Min	Typ	Max	Unit
Static Characteristics						
Drain-Source Breakdown Voltage	$V_{(BR)DSS}$	$V_{GS}=0V, I_D=-250\mu A$	-20			V
Gate-Threshold Voltage	$V_{GS(th)}$	$V_{DS}=V_{GS}, I_D=-250\mu A$	-0.55		-0.9	V
Gate-Body Leakage Current	I_{GSS}	$V_{GS}=\pm 8V, V_{DS}=0V$			± 100	nA
Zero Gate Voltage Drain Current	I_{DSS}	$V_{DS}=-20V, V_{GS}=0V$			-1	μA
Drain-Source On-Resistance ^(Note 2)	$R_{DS(on)}$	$V_{GS}=-4.5V, I_D=-4.2A$		7.0	8.5	m Ω
		$V_{GS}=-2.5V, I_D=-3.2A$		8.0	11	
		$V_{GS}=-1.8V, I_D=-2.2A$		10	14	
Forward Transconductance ^(Note 2)	g_{FS}	$V_{DS}=-5V, I_D=-4.1A$	6			S
Dynamic Characteristics						
Input Capacitance ^(Note 1,3)	C_{iss}	$V_{DS}=-10V, V_{GS}=0V, f=1MHz$		1255		pF
Output Capacitance ^(Note 1,3)	C_{oss}			220		
Reverse Transfer Capacitance ^(Note 1,3)	C_{rss}			190		
Total Gate Charge ^(Note 1)	Q_g	$V_{DS}=-10V, V_{GS}=-10V, I_D=-8A$		29		nC
Gate-Source Charge ^(Note 1)	Q_{gs}	$V_{DS}=-10V, V_{GS}=-10V, I_D=-8A$		5.2		
Gate-Drain Charge ^(Note 1)	Q_{gd}			6.3		
Gate Resistance ^(Note 1,3)	R_g	$f=1MHz$		3.6		Ω
Turn-On Delay Time ^(Note 1,3)	$t_{d(on)}$	$V_{DD}=-4V, V_{GEN}=-4.5V, R_L=1.2\Omega, I_D=-3.3A, R_G=1\Omega$		230		ns
Turn-On Rise Time ^(Note 1,3)	t_r			800		
Turn-Off Delay Time ^(Note 1,3)	$t_{d(off)}$			3000		
Turn-Off Fall Time ^(Note 1,3)	t_f			2000		
Drain-Source Body Diode Characteristics						
Continuous Source-Drain Diode Current	I_S	$T_C=25^\circ C$			-8.2	A
Pulse Diode Forward Current ^(Note 2)	I_{SM}				-20	
Body Diode Voltage	V_{SD}	$I_F=-8.2A$		-0.8	-1.2	V

Note:

1. Guaranteed by Design, Not Subject to Production Testing.
2. Pulse Test: Pulse Width $\leq 300\mu s$, Duty Cycle $\leq 2\%$.
3. These Parameters Have No Way to Verify.

Curve Characteristics

Fig. 1 - Typical Output Characteristics

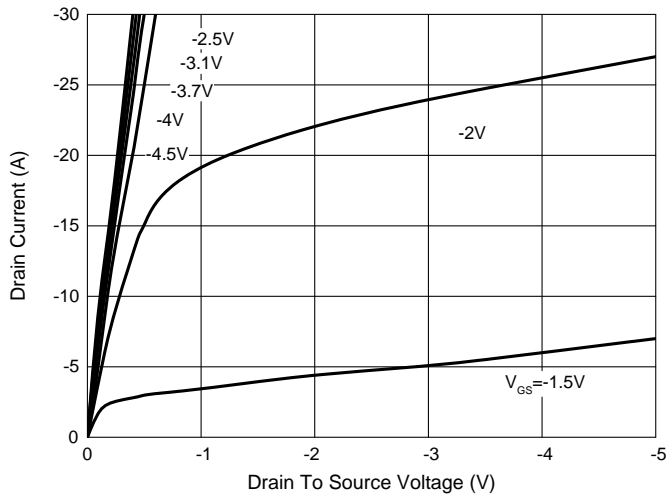

Fig. 2 - Normalized On Resistance Characteristics

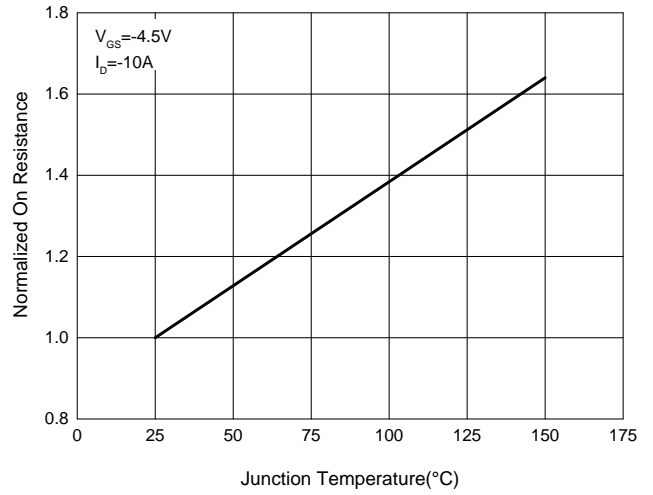

Fig. 3 - Transfer Characteristics

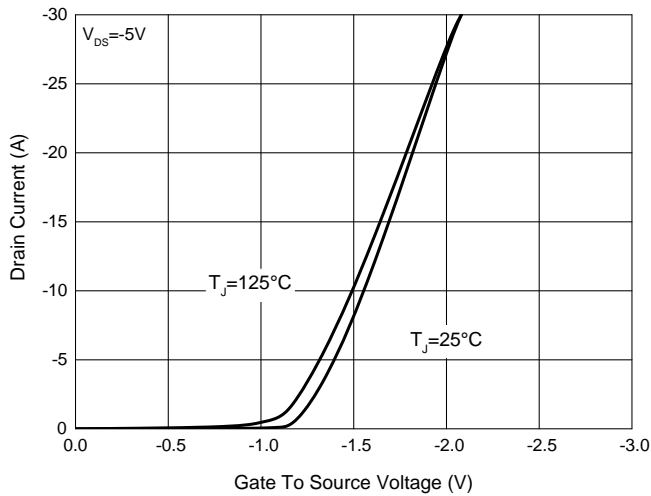

Fig. 4 - Total Gate Charge Characteristics

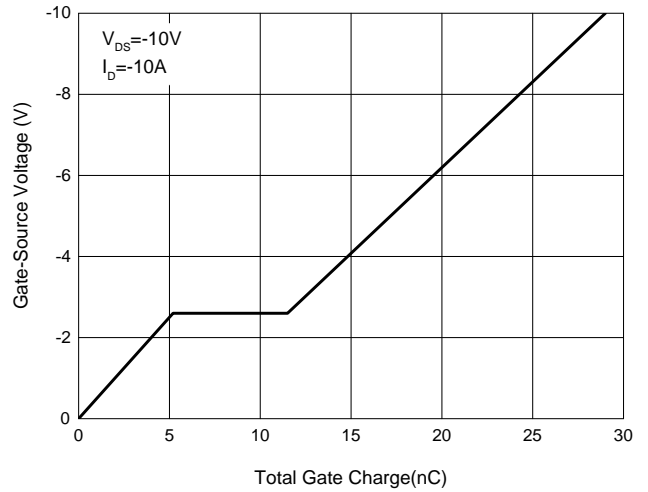

Fig. 5 - $R_{DS(ON)} - I_D$

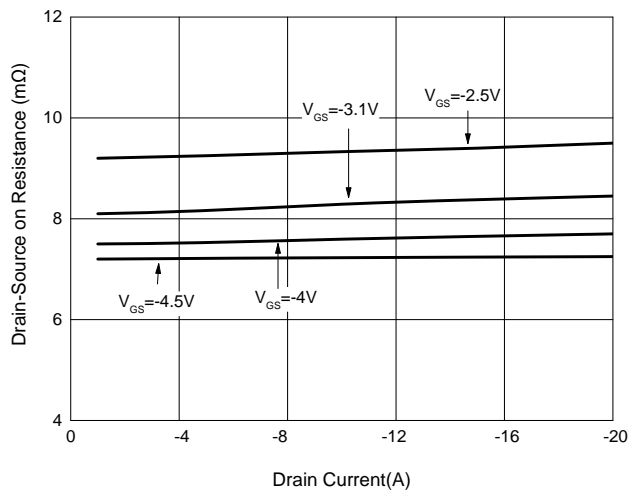
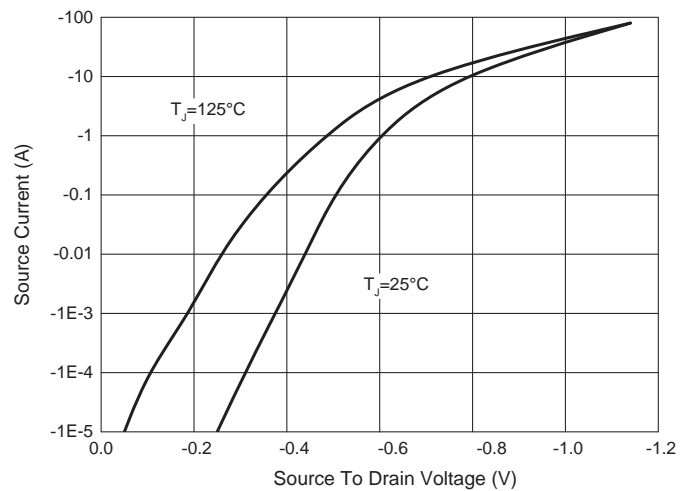

Fig. 6 - $I_S - V_{SD}$



Ordering Information

Device	Packing
Part Number-TP	Tape&Reel:5Kpcs/Reel

Note : Adding "-HF" Suffix For Halogen Free, eg. Part Number-TP-HF

IMPORTANT NOTICE

Micro Commercial Components Corp. reserves the right to make changes without further notice to any product herein to make corrections, modifications , enhancements , improvements , or other changes . **Micro Commercial Components Corp** . does not assume any liability arising out of the application or use of any product described herein; neither does it convey any license under its patent rights ,nor the rights of others . The user of products in such applications shall assume all risks of such use and will agree to hold **Micro Commercial Components Corp** . and all the companies whose products are represented on our website, harmless against all damages.

LIFE SUPPORT

MCC's products are not authorized for use as critical components in life support devices or systems without the express written approval of Micro Commercial Components Corporation.

CUSTOMER AWARENESS

Counterfeiting of semiconductor parts is a growing problem in the industry. Micro Commercial Components (MCC) is taking strong measures to protect ourselves and our customers from the proliferation of counterfeit parts. MCC strongly encourages customers to purchase MCC parts either directly from MCC or from Authorized MCC Distributors who are listed by country on our web page cited below. Products customers buy either from MCC directly or from Authorized MCC Distributors are genuine parts, have full traceability, meet MCC's quality standards for handling and storage. **MCC will not provide any warranty coverage or other assistance for parts bought from Unauthorized Sources.** MCC is committed to combat this global problem and encourage our customers to do their part in stopping this practice by buying direct or from authorized distributors.