

BDCD Series



BDCD Series provides high current in compact package size with magnetically shielded construction. This power inductor is an excellent power solution for space-limited devices.

Features

- RoHS, Halogen Free and REACH Compliance
- Monolithic, magnetically shielded
- Capable for large current

Applications

- Smartphones, tablets and wearable devices
- HDD, SSD and PC peripheral devices
- DSC, camcoders
- PND
- DC/DC converters

Product Identification

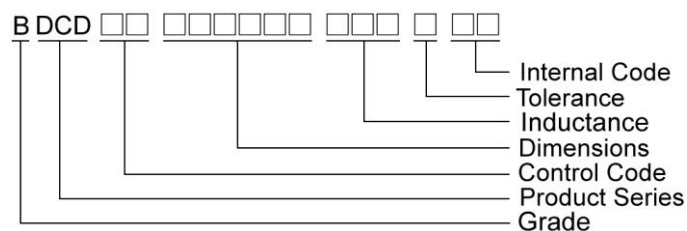

Shape and Dimensions

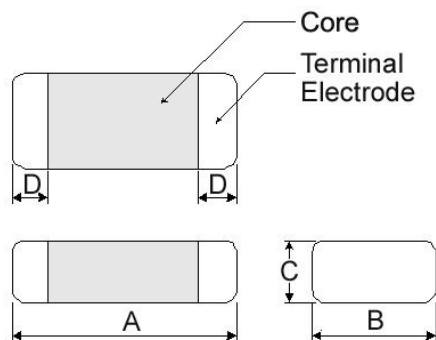

Dimensions in mm

| TYPE | A | B | C | D |
|--------------|---------|---------|--------|---------|
| BDCD00201610 | 2.0±0.2 | 1.6±0.2 | 1.0Max | 0.5±0.3 |
| BDCD00201612 | 2.0±0.2 | 1.6±0.2 | 1.2Max | 0.5±0.3 |
| BDCD00252010 | 2.5±0.2 | 2.0±0.2 | 1.0Max | 0.6±0.3 |
| BDCD00252012 | 2.5±0.2 | 2.0±0.2 | 1.2Max | 0.6±0.3 |
| BDCD00322510 | 3.2±0.3 | 2.5±0.3 | 1.0Max | 0.5±0.3 |
| BDCD00322512 | 3.2±0.3 | 2.5±0.3 | 1.2Max | 0.5±0.3 |

Recommended Pattern

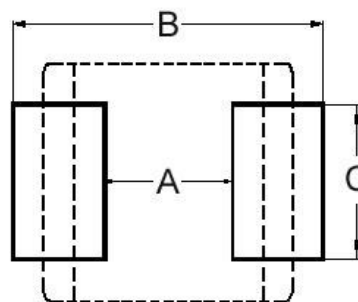

Dimensions in mm

| TYPE | A | B | C |
|--------------|-----|-----|-----|
| BDCD00201610 | 0.7 | 2.3 | 1.8 |
| BDCD00201612 | 0.7 | 2.3 | 1.8 |
| BDCD00252010 | 1.2 | 2.8 | 2.3 |
| BDCD00252012 | 1.2 | 2.8 | 2.3 |
| BDCD00322510 | 1.7 | 3.5 | 2.8 |
| BDCD00322512 | 1.7 | 3.5 | 2.8 |

Molding Power Inductors – BDCD Series

Electrical Characteristics

| Part Number | Inductance (uH) | Tolerance (±%) | Test Frequency (MHz) | RDC(mΩ) Max(Typ.) | Isat(A) Max(Typ.) | Irms(A) Max(Typ.) |
|--------------------|-----------------|----------------|----------------------|-------------------|-------------------|-------------------|
| BDCD00201610R24MS1 | 0.24 | 20 | 2 | 40(28) | 4.2(6.0) | 4.0(4.5) |
| BDCD00201610R33MS1 | 0.33 | 20 | 2 | 48(40) | 4.0(5.5) | 3.5(3.8) |
| BDCD00201610R47MS1 | 0.47 | 20 | 2 | 54(44) | 3.2(5.0) | 3.0(3.6) |
| BDCD00201610R56MS1 | 0.56 | 20 | 2 | 59(46) | 2.8(4.6) | 2.8(3.3) |
| BDCD00201610R68MS1 | 0.68 | 20 | 2 | 72(55) | 2.7(4.2) | 2.4(3.0) |
| BDCD002016101R0MS1 | 1.0 | 20 | 2 | 96(81) | 2.2(3.4) | 2.0(2.3) |
| BDCD002016101R5MS1 | 1.5 | 20 | 2 | 150(122) | 2.1(2.8) | 1.6(2.0) |
| BDCD002016102R2MS1 | 2.2 | 20 | 2 | 204(170) | 2.0(2.4) | 1.3(1.6) |

Note: When ordering, please specify tolerance code. Tolerance: M=±20%

- Operating temperature range - 40°C ~ 125°C(Including self - temperature rise)
- Isat for Inductance drop 30% from its value without current
- I rms for a 40°C temperature rise from 25°C ambient with current
- Rated current : Isat or I rms, whichever is smaller
- Absolute maximum voltage 20VDC
- Measure Equipment :
 L : Agilent E4991/HP4286A+16197A (or equivalent), 2MHz 0.2V
 RDC : CHEN HWA502BC/HP4338B (or equivalent)
 Isat : Agilent E4980A+HP42841A (or equivalent)
 I rms : Agilent 6641 SYSTEM DC POWER SUPPLY (or equivalent)

Test Instruments : E4991A Impedance / Material Analyzer

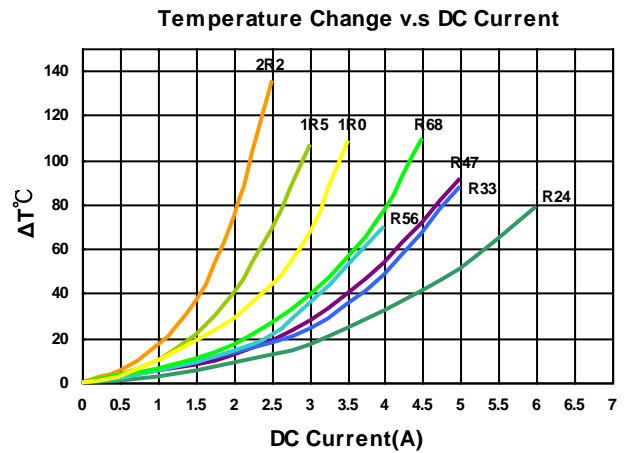
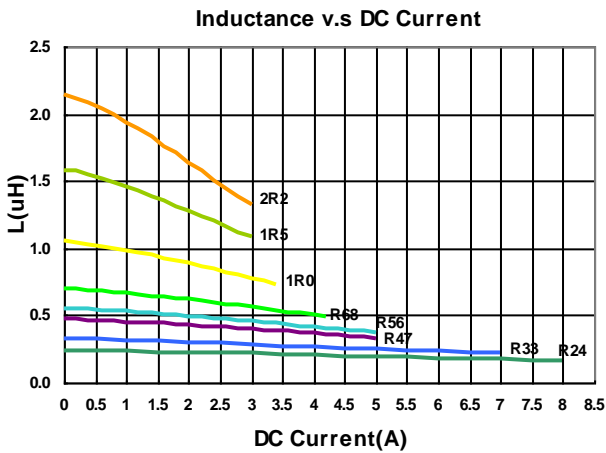

Molding Power Inductors – BDCD Series

Electrical Characteristics

| Part Number | Inductance (uH) | Tolerance (±%) | Test Frequency (MHz) | RDC(mΩ) Max(Typ.) | Isat(A) Max(Typ.) | Irms(A) Max(Typ.) |
|--------------------|-----------------|----------------|----------------------|-------------------|-------------------|-------------------|
| BDCD00201610R24ML1 | 0.24 | 20 | 2 | 30(23) | 5.0(6.0) | 3.8(4.4) |
| BDCD00201610R33ML1 | 0.33 | 20 | 2 | 35(27) | 4.5(5.0) | 3.4(3.8) |
| BDCD00201610R47ML1 | 0.47 | 20 | 2 | 41(34) | 4.0(4.5) | 2.9(3.3) |
| BDCD00201610R68ML1 | 0.68 | 20 | 2 | 53(44) | 3.3(3.6) | 2.5(2.9) |
| BDCD002016101R0ML1 | 1.0 | 20 | 2 | 72(60) | 2.8(3.2) | 2.2(2.5) |
| BDCD002016101R5ML1 | 1.5 | 20 | 2 | 110(92) | 2.2(2.8) | 1.8(2.1) |
| BDCD002016102R2ML1 | 2.2 | 20 | 2 | 170(142) | 1.8(2.1) | 1.5(1.7) |

Note: When ordering, please specify tolerance code. Tolerance: M=±20%

- Operating temperature range - 40°C ~ 125°C(Including self - temperature rise)
- Isat for Inductance drop 30% from its value without current
- Irms for a 40°C temperature rise from 25°C ambient with current
- Rated current : Isat or Irms, whichever is smaller
- Absolute maximum voltage 20VDC
- Measure Equipment :
 - L : Agilent E4991/HP4286A+16197A (or equivalent), 2MHz 0.2V
 - RDC : CHEN HWA502BC/HP4338B (or equivalent)
 - Isat : Agilent E4980A+HP42841A (or equivalent)
 - Irms : Agilent 6641 SYSTEM DC POWER SUPPLY (or equivalent)

Test Instruments : E4991A Impedance / Material Analyzer

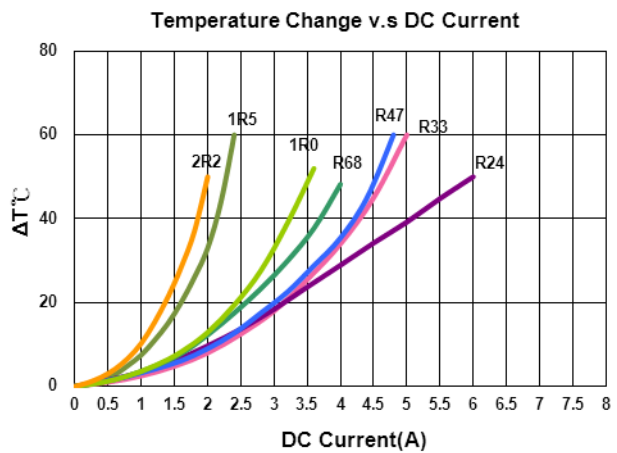
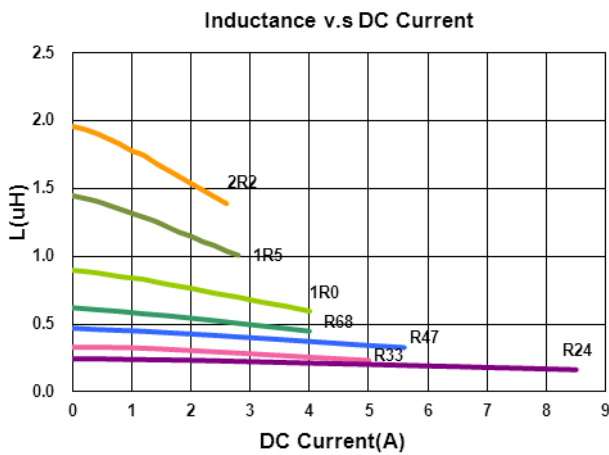

Molding Power Inductors – BDCD Series

Electrical Characteristics

| Part Number | Inductance (uH) | Tolerance (±%) | Test Frequency (MHz) | RDC(mΩ) Max(Typ.) | Isat(A) Max(Typ.) | Irms(A) Max(Typ.) |
|--------------------|-----------------|----------------|----------------------|-------------------|-------------------|-------------------|
| BDCD00201612R24MS1 | 0.24 | 20 | 2 | 35(25) | 5.5(6.5) | 4.2(4.8) |
| BDCD00201612R47MS1 | 0.47 | 20 | 2 | 52(40) | 3.8(5.1) | 3.2(3.8) |
| BDCD00201612R68MS1 | 0.68 | 20 | 2 | 70(53) | 3.3(4.8) | 2.6(3.2) |
| BDCD002016121R0MS1 | 1.0 | 20 | 2 | 82(67) | 3.1(3.9) | 2.3(2.7) |
| BDCD002016121R5MS1 | 1.5 | 20 | 2 | 120(95) | 2.6(3.2) | 2.2(2.6) |
| BDCD002016122R2MS1 | 2.2 | 20 | 2 | 195(165) | 2.0(2.6) | 1.3(1.7) |

Note: When ordering, please specify tolerance code. Tolerance: M=±20%

- Operating temperature range - 40°C ~ 125°C(Including self - temperature rise)
- Isat for Inductance drop 30% from its value without current
- I rms for a 40°C temperature rise from 25°C ambient with current
- Rated current : Isat or I rms, whichever is smaller
- Absolute maximum voltage 20VDC
- Measure Equipment :
 L : Agilent E4991/HP4286A+16197A (or equivalent), 2MHz 0.2V
 RDC : CHEN HWA502BC/HP4338B (or equivalent)
 Isat : Agilent E4980A+HP42841A (or equivalent)
 I rms : Agilent 6641 SYSTEM DC POWER SUPPLY (or equivalent)

Test Instruments : E4991A Impedance / Material Analyzer

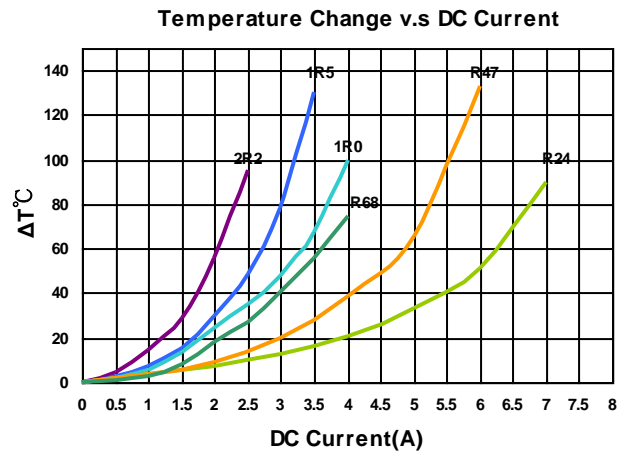
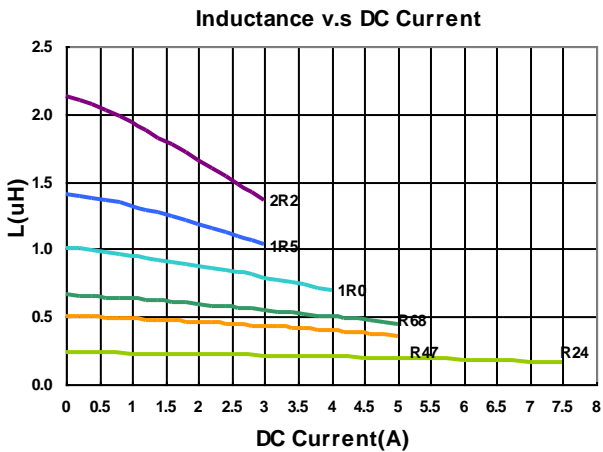

Molding Power Inductors – BDCD Series

Electrical Characteristics

| Part Number | Inductance (uH) | Tolerance (±%) | Test Frequency (MHz) | RDC(mΩ) Max(Typ.) | Isat(A) Max(Typ.) | Irms(A) Max(Typ.) |
|--------------------|-----------------|----------------|----------------------|-------------------|-------------------|-------------------|
| BDCD00252010R24MS1 | 0.24 | 20 | 2 | 40(24) | 7.5(9.5) | 4.5(5.0) |
| BDCD00252010R47MS1 | 0.47 | 20 | 2 | 46(36) | 5.2(6.5) | 3.1(3.6) |
| BDCD00252010R68MS1 | 0.68 | 20 | 2 | 65(49) | 3.8(5.0) | 2.9(3.3) |
| BDCD002520101R0MS1 | 1.0 | 20 | 2 | 78(60) | 3.4(4.3) | 2.5(3.0) |
| BDCD002520101R5MS1 | 1.5 | 20 | 2 | 105(82) | 3.2(4.0) | 2.2(2.9) |
| BDCD002520102R2MS1 | 2.2 | 20 | 2 | 156(130) | 2.6(3.2) | 1.4(1.8) |

Note: When ordering, please specify tolerance code. Tolerance: M=±20%

- Operating temperature range - 40°C ~ 125°C(Including self - temperature rise)
- Isat for Inductance drop 30% from its value without current
- Irms for a 40°C temperature rise from 25°C ambient with current
- Rated current : Isat or Irms, whichever is smaller
- Absolute maximum voltage 20VDC
- Measure Equipment :
 L : Agilent E4991/HP4286A+16197A (or equivalent), 2MHz 0.2V
 RDC : CHEN HWA502BC/HP4338B (or equivalent)
 Isat : Agilent E4980A+HP42841A (or equivalent)
 Irms : Agilent 6641 SYSTEM DC POWER SUPPLY (or equivalent)

Test Instruments : E4991A Impedance / Material Analyzer

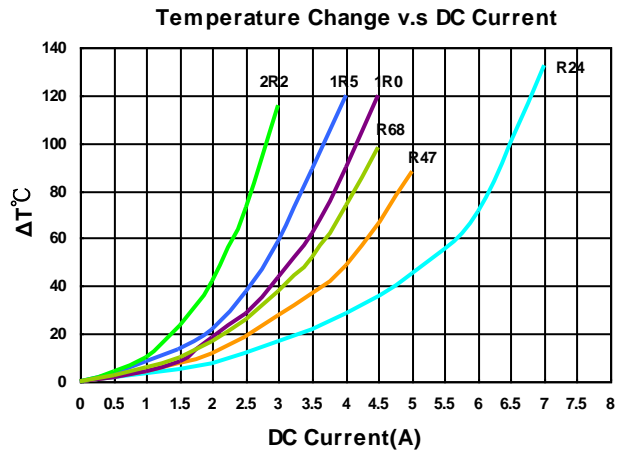
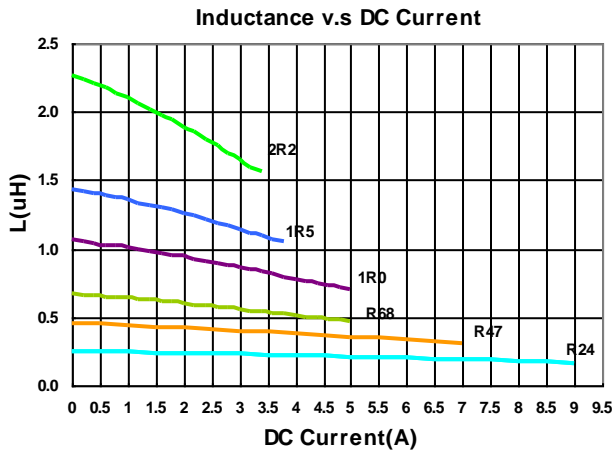

Molding Power Inductors – BDCD Series

Electrical Characteristics

| Part Number | Inductance (uH) | Tolerance (±%) | Test Frequency (MHz) | RDC(mΩ) Max(Typ.) | Isat(A) Max(Typ.) | Irms(A) Max(Typ.) |
|--------------------|-----------------|----------------|----------------------|-------------------|-------------------|-------------------|
| BDCD00252010R33ML1 | 0.33 | 20 | 2 | 31(25) | 5.0(6.0) | 3.8(4.4) |
| BDCD00252010R47ML1 | 0.47 | 20 | 2 | 35(29) | 4.2(4.7) | 3.4(3.9) |
| BDCD00252010R68ML1 | 0.68 | 20 | 2 | 48(40) | 3.7(4.0) | 3.0(3.5) |
| BDCD002520101R0ML1 | 1.0 | 20 | 2 | 65(54) | 3.2(3.6) | 2.6(3.0) |
| BDCD002520101R5ML1 | 1.5 | 20 | 2 | 94(78) | 2.9(3.3) | 2.1(2.4) |
| BDCD002520102R2ML1 | 2.2 | 20 | 2 | 120(100) | 2.3(2.7) | 1.8(2.1) |

Note: When ordering, please specify tolerance code. Tolerance: M=±20%

- Operating temperature range - 40°C ~ 125°C(Including self - temperature rise)
- Isat for Inductance drop 30% from its value without current
- I rms for a 40°C temperature rise from 25°C ambient with current
- Rated current : Isat or I rms, whichever is smaller
- Absolute maximum voltage 20VDC
- Measure Equipment :
 - L : Agilent E4991/HP4286A+16197A (or equivalent), 2MHz 0.2V
 - RDC : CHEN HWA502BC/HP4338B (or equivalent)
 - Isat : Agilent E4980A+HP42841A (or equivalent)
 - I rms : Agilent 6641 SYSTEM DC POWER SUPPLY (or equivalent)

Test Instruments : E4991A Impedance / Material Analyzer

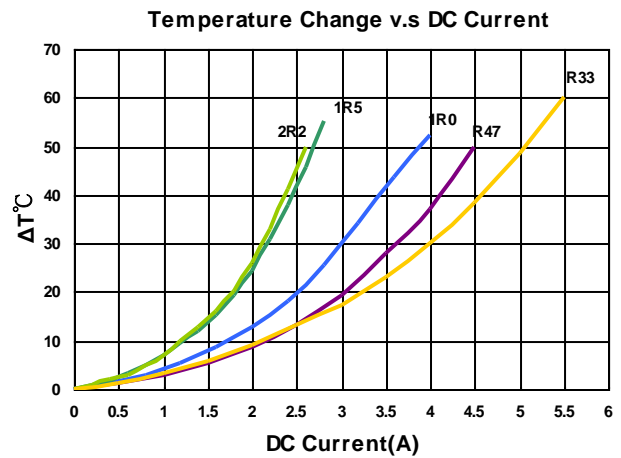
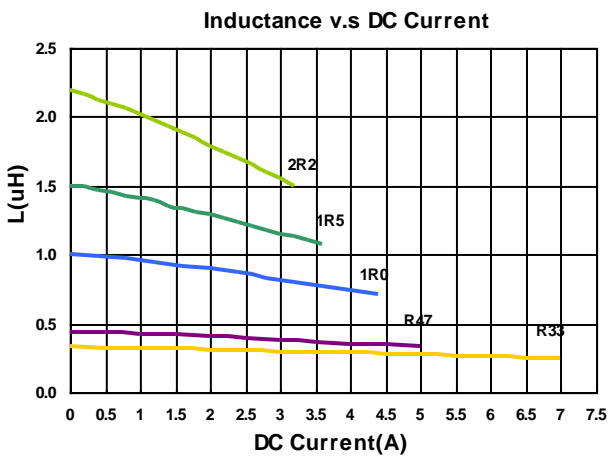

Molding Power Inductors – BDCD Series

Electrical Characteristics

| Part Number | Inductance (uH) | Tolerance (±%) | Test Frequency (MHz) | RDC(mΩ) Max(Typ.) | Isat(A) Max(Typ.) | Irms(A) Max(Typ.) |
|--------------------|-----------------|----------------|----------------------|-------------------|-------------------|-------------------|
| BDCD00252012R33MS1 | 0.33 | 20 | 2 | 35(27) | 6.8(8.5) | 4.0(4.6) |
| BDCD00252012R47MS1 | 0.47 | 20 | 2 | 39(29) | 6.2(7.8) | 3.7(4.4) |
| BDCD00252012R68MS1 | 0.68 | 20 | 2 | 46(40) | 5.5(6.5) | 3.3(3.7) |
| BDCD002520121R0MS1 | 1.0 | 20 | 2 | 59(45) | 4.0(5.0) | 3.0(3.5) |
| BDCD002520121R5MS1 | 1.5 | 20 | 2 | 70(62) | 3.4(4.0) | 2.5(2.7) |
| BDCD002520122R2MS1 | 2.2 | 20 | 2 | 115(102) | 3.3(3.8) | 2.0(2.3) |

Note: When ordering, please specify tolerance code. Tolerance: M=±20%

- Operating temperature range - 40°C ~ 125°C(Including self - temperature rise)
- Isat for Inductance drop 30% from its value without current
- I rms for a 40°C temperature rise from 25°C ambient with current
- Rated current : Isat or I rms, whichever is smaller
- Absolute maximum voltage 20VDC
- Measure Equipment :
 - L : Agilent E4991/HP4286A+16197A (or equivalent), 2MHz 0.2V
 - RDC : CHEN HWA502BC/HP4338B (or equivalent)
 - Isat : Agilent E4980A+HP42841A (or equivalent)
 - I rms : Agilent 6641 SYSTEM DC POWER SUPPLY (or equivalent)

Test Instruments : E4991A Impedance / Material Analyzer

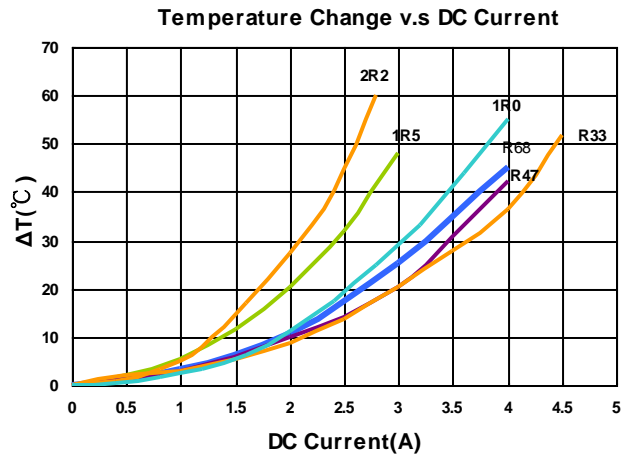
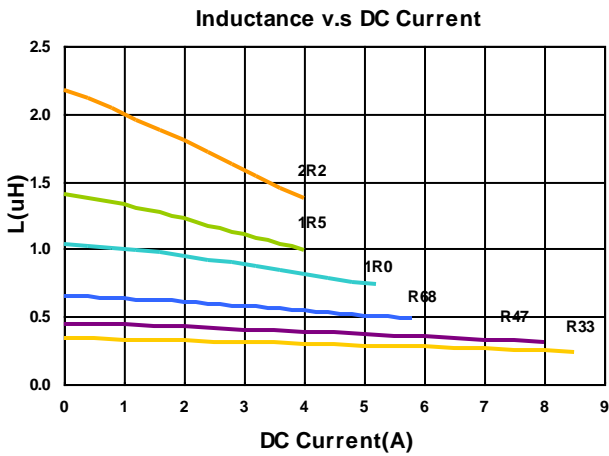

Molding Power Inductors – BDCD Series

Electrical Characteristics

| Part Number | Inductance (uH) | Tolerance (±%) | Test Frequency (MHz) | RDC(mΩ) Max(Typ.) | Isat(A) Max(Typ.) | Irms(A) Max(Typ.) |
|--------------------|-----------------|----------------|----------------------|-------------------|-------------------|-------------------|
| BDCD00252012R47ML1 | 0.47 | 20 | 2 | 34(30) | 5.2(6.0) | 4.1(4.7) |
| BDCD002520121R0ML1 | 1.0 | 20 | 2 | 56(45) | 3.6(4.5) | 3.2(3.7) |
| BDCD002520122R2ML1 | 2.2 | 20 | 2 | 102(80) | 2.5(3.0) | 2.2(2.6) |

Note: When ordering, please specify tolerance code. Tolerance: M=±20%

- Operating temperature range - 40°C ~ 125°C(Including self - temperature rise)
- Isat for Inductance drop 30% from its value without current
- I rms for a 40°C temperature rise from 25°C ambient with current
- Rated current : Isat or I rms, whichever is smaller
- Absolute maximum voltage 20VDC
- Measure Equipment :
 L : Agilent E4991/HP4286A+16197A (or equivalent), 2MHz 0.2V
 RDC : CHEN HWA502BC/HP4338B (or equivalent)
 Isat : Agilent E4980A+HP42841A (or equivalent)
 I rms : Agilent 6641 SYSTEM DC POWER SUPPLY (or equivalent)

Test Instruments : E4991A Impedance / Material Analyzer

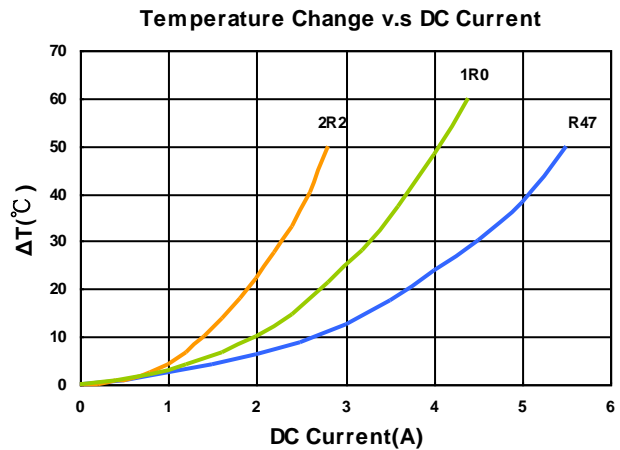
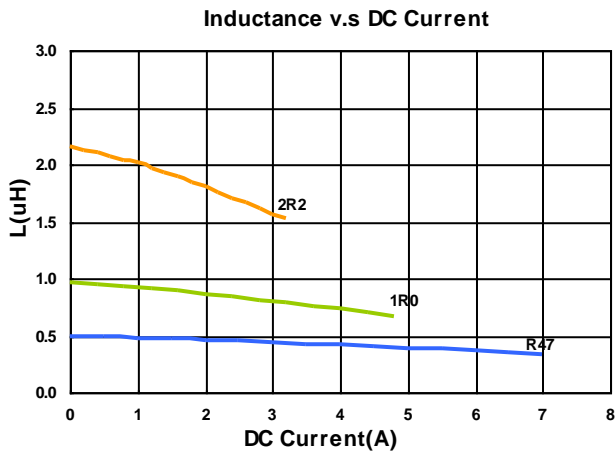

Molding Power Inductors – BDCD Series

Electrical Characteristics

| Part Number | Inductance (uH) | Tolerance (±%) | Test Frequency (MHz) | RDC(mΩ) Max(Typ.) | Isat(A) Max(Typ.) | Irms(A) Max(Typ.) |
|--------------------|-----------------|----------------|----------------------|-------------------|-------------------|-------------------|
| BDCD00322510R47MS1 | 0.47 | 20 | 2 | 37(30) | 5.8(6.6) | 3.6(4.2) |
| BDCD003225101R0MS1 | 1.0 | 20 | 2 | 56(49) | 4.0(4.6) | 3.0(3.3) |
| BDCD003225101R5MS1 | 1.5 | 20 | 2 | 75(66) | 3.4(4.0) | 2.6(3.0) |
| BDCD003225102R2MS1 | 2.2 | 20 | 2 | 108(95) | 2.7(3.2) | 2.2(2.5) |

Note: When ordering, please specify tolerance code. Tolerance: M=±20%

- Operating temperature range - 40°C ~ 125°C(Including self - temperature rise)
- Isat for Inductance drop 30% from its value without current
- I rms for a 40°C temperature rise from 25°C ambient with current
- Rated current : Isat or I rms, whichever is smaller
- Absolute maximum voltage 20VDC
- Measure Equipment :
 L : Agilent E4991/HP4286A+16197A (or equivalent), 2MHz 0.2V
 RDC : CHEN HWA502BC/HP4338B (or equivalent)
 Isat : Agilent E4980A+HP42841A (or equivalent)
 I rms : Agilent 6641 SYSTEM DC POWER SUPPLY (or equivalent)

Test Instruments : E4991A Impedance / Material Analyzer

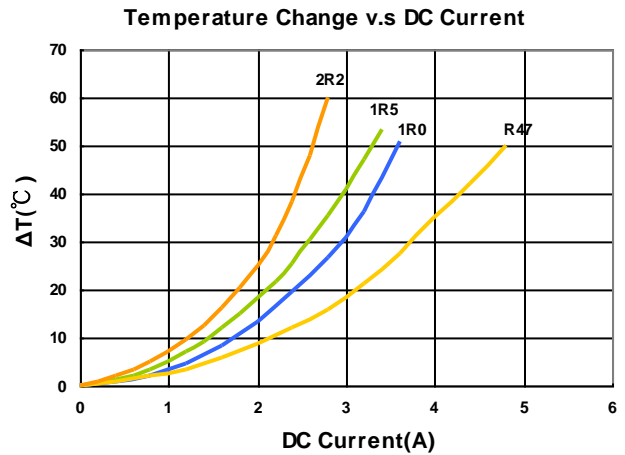
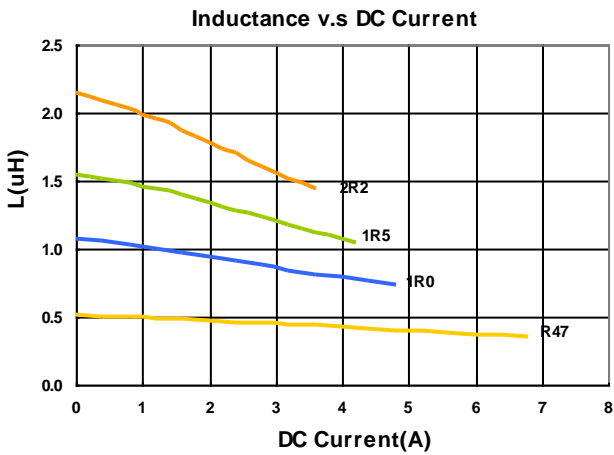

Molding Power Inductors – BDCD Series

Electrical Characteristics

| Part Number | Inductance (uH) | Tolerance (±%) | Test Frequency (MHz) | RDC(mΩ) Max(Typ.) | Isat(A) Max(Typ.) | Irms(A) Max(Typ.) |
|--------------------|-----------------|----------------|----------------------|-------------------|-------------------|-------------------|
| BDCD00322512R47MS1 | 0.47 | 20 | 2 | 27(21) | 8.0(9.0) | 5.0(5.8) |
| BDCD00322512R68MS1 | 0.68 | 20 | 2 | 34(26) | 6.3(7.5) | 4.0(4.6) |
| BDCD003225121R0MS1 | 1.0 | 20 | 2 | 42(34) | 5.8(6.3) | 3.8(4.2) |
| BDCD003225121R5MS1 | 1.5 | 20 | 2 | 68(58) | 4.0(4.5) | 2.8(3.2) |
| BDCD003225122R2MS1 | 2.2 | 20 | 2 | 85(75) | 3.6(4.0) | 2.4(2.7) |

Note: When ordering, please specify tolerance code. Tolerance: M=±20%

- Operating temperature range - 40°C ~ 125°C(Including self - temperature rise)
- Isat for Inductance drop 30% from its value without current
- I rms for a 40°C temperature rise from 25°C ambient with current
- Rated current : Isat or I rms, whichever is smaller
- Absolute maximum voltage 20VDC
- Measure Equipment :
 L : Agilent E4991/HP4286A+16197A (or equivalent), 2MHz 0.2V
 RDC : CHEN HWA502BC/HP4338B (or equivalent)
 Isat : Agilent E4980A+HP42841A (or equivalent)
 I rms : Agilent 6641 SYSTEM DC POWER SUPPLY (or equivalent)

Test Instruments : E4991A Impedance / Material Analyzer

Inductance v.s DC Current

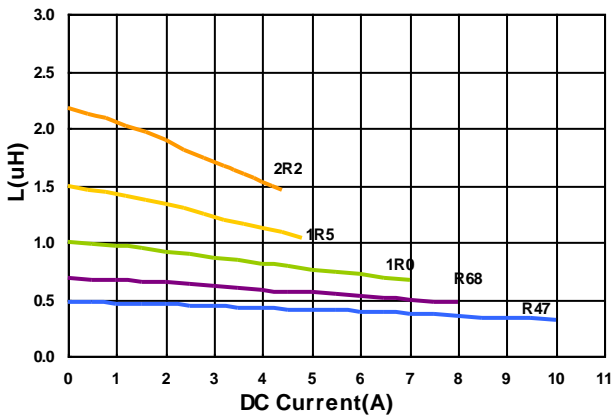

Temperature Change v.s DC Current

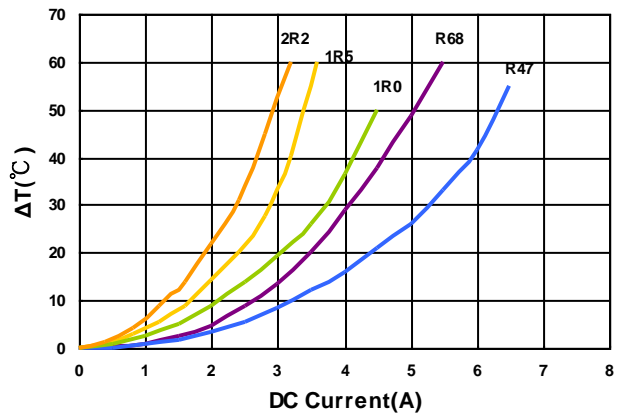

Packaging Specifications

Tape Dimensions

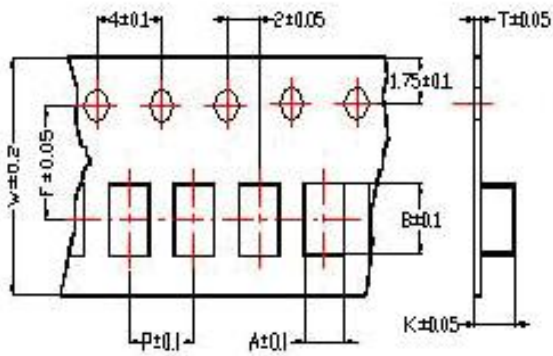

Tape Material

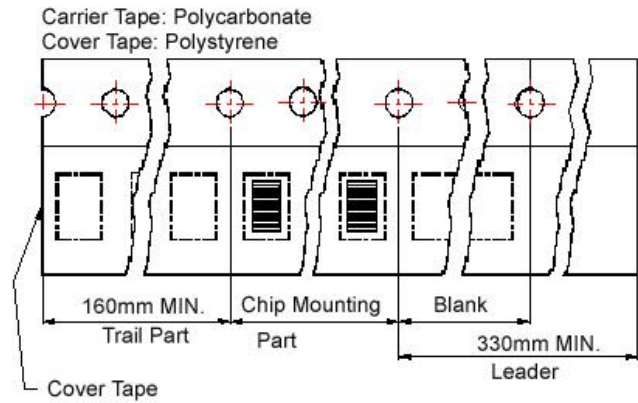

Reel Dimensions

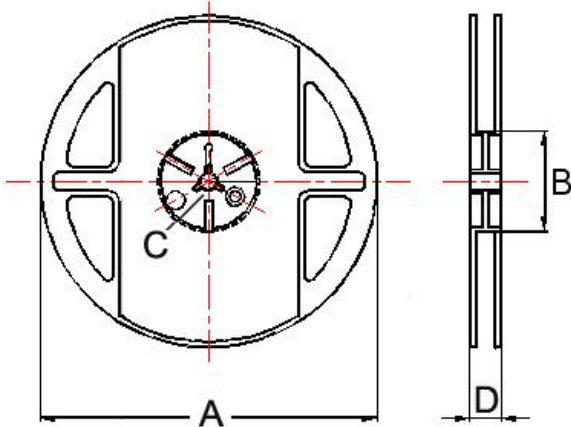

Dimensions in mm

| TYPE | Tape Dimensions | | | | | | | Reel Dimensions | | | | Quantity PCS / REEL |
|--------------|-----------------|------|------|---|---|-----|------|-----------------|----|----|-----|------------------------|
| | A | B | T | W | P | F | K | A | B | C | D | |
| BDCD00201610 | 1.80 | 2.20 | 0.22 | 8 | 4 | 3.5 | 1.15 | 178 | 60 | 12 | 1.5 | 3000 |
| BDCD00201612 | 1.80 | 2.20 | 0.22 | 8 | 4 | 3.5 | 1.15 | 178 | 60 | 12 | 1.5 | 3000 |
| BDCD00252010 | 2.25 | 2.80 | 0.22 | 8 | 4 | 3.5 | 1.15 | 178 | 60 | 12 | 1.5 | 3000 |
| BDCD00252012 | 2.25 | 2.80 | 0.22 | 8 | 4 | 3.5 | 1.35 | 178 | 60 | 12 | 1.5 | 3000 |
| BDCD00322510 | 2.80 | 3.55 | 0.23 | 8 | 4 | 3.5 | 1.20 | 178 | 60 | 12 | 1.5 | 3000 |
| BDCD00322512 | 2.80 | 3.50 | 0.23 | 8 | 4 | 3.5 | 1.34 | 178 | 60 | 12 | 1.5 | 3000 |