

1 Features

- Single-Supply or Dual Supplies
- Wide Range of Supply Voltage
 - Maximum Rating: 2 V to 36 V
 - Tested to 30 V: Non-V Devices
 - Tested to 32 V: V-Suffix Devices
- Low Supply-Current Drain Independent of Supply Voltage: 0.4 mA (Typical) Per Comparator
- Low Input Bias Current: 25 nA (Typical)
- Low Input Offset Current: 3 nA (Typical) (XL193)
- Low Input Offset Voltage: 2 mV (Typical)
- Common-Mode Input Voltage Range Includes Ground
- Differential Input Voltage Range Equal to Maximum-Rated Supply Voltage: ± 36 V
- Low Output Saturation Voltage
- Output Compatible With TTL, MOS, and CMOS
- On Products Compliant to MIL-PRF-38535, All Parameters Are Tested Unless Otherwise Noted. On All Other Products, Production Processing Does Not Necessarily Include Testing of All Parameters.

2 Applications

- Chemical or Gas Sensor
- Desktop PC
- Motor Control: AC Induction
- Weigh Scale

3 Description

These devices consist of two independent voltage comparators that are designed to operate from a single power supply over a wide range of voltages. Operation from dual supplies also is possible as long as the difference between the two supplies is 2 V to 36 V, and V_{CC} is at least 1.5 V more positive than the input common-mode voltage. Current drain is independent of the supply voltage. The outputs can be connected to other open-collector outputs to achieve wired-AND relationships.

The XL193 device is characterized for operation from -55°C to 125°C . The XL293D-8 and XD293 devices are characterized for operation from -25°C to 85°C . The XL393 and XD393 devices are characterized for operation from 0°C to 70°C . The XL2903 device is characterized for operation from -40°C to 125°C .

4 Device Information⁽¹⁾

PART NUMBER	PACKAGE	BODY SIZE (NOM)
XL193 XL293D-8 XL393 XL2903	SOIC (8)	4.90 mm x 6.00 mm
XL293K XL393K XL2903K	VSSOP (8)	3.00 mm x 5.00 mm
XD293 XD393 XD2903	PDIP (8)	9.50 mm x 6.30 mm
XL393W XL2903W	SO (8)	6.20 mm x 7.90 mm
XL393W XL2903W	TSSOP (8)	6.40 mm x 3.00 mm
XD193CD	GDIP (8)	10.00 mm x 7.00 mm
XK193K	CQCC (8)	9.00 mm x 9.00 mm

(1) For all available packages, see the orderable addendum at the end of the data sheet.

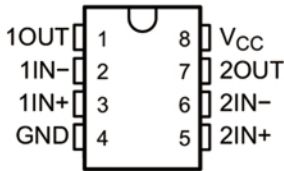
Simplified Schematic



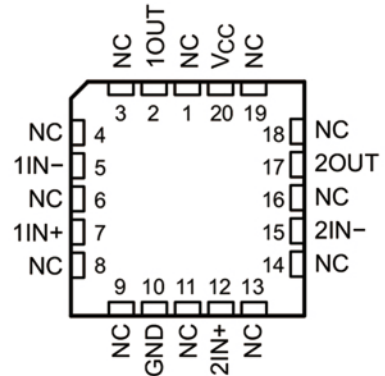
XL193 SOP8/XL293D-8/XL393 SOP8/XL2903 SOP8 XD293 DIP8/XD393 DIP8 XD2903 DIP8

5 Pin Configuration and Functions

D, DGK, JG, P, PS, or PW
8-Pin SOIC, VSSOP, GDIP, PDIP, SO, or TSSOP
Top View



FK Package
20-Pin CQCC
Top View



NC – No internal connection

Pin Functions

PIN			I/O	DESCRIPTION
NAME	SOIC, VSSOP, GDIP, PDIP, SO, or TSSOP	LCCC		
1OUT	1	2	Output	Output pin of comparator 1
1IN-	2	5	Input	Negative input pin of comparator 1
1IN+	3	7	Input	Positive input pin of comparator 1
GND	4	10	Input	Ground
2IN+	5	12	Input	Positive input pin of comparator 2
2IN-	6	15	Input	Negative input pin of comparator 2
2OUT	7	17	Output	Output pin of comparator 2
V _{CC}	8	20	Input	Supply Pin
NC	—	1	N/A	No Connect (No Internal Connection)
		3		
		4		
		6		
		8		
		9		
		11		
		13		
		14		
		16		
18				
19				

XL193 SOP8/XL293D-8/XL393 SOP8/XL2903 SOP8 XD293 DIP8/XD393 DIP8 XD2903 DIP8

6 Specifications

6.1 Absolute Maximum Ratings

over operating free-air temperature range (unless otherwise noted)⁽¹⁾

	MIN	MAX	UNIT
V _{CC} Supply voltage ⁽²⁾		36	V
V _{ID} Differential input voltage ⁽³⁾		±36	V
V _I Input voltage (either input)	-0.3	36	V
V _O Output voltage		36	V
I _O Output current		20	mA
Duration of output short circuit to ground ⁽⁴⁾	Unlimited		
T _J Operating virtual-junction temperature		150	°C
Case temperature for 60 s	FK package	260	°C
Lead temperature 1,6 mm (1/16 in) from case for 60 s	J package	300	°C
T _{stg} Storage temperature	-65	150	°C

- (1) Stresses beyond those listed under *Absolute Maximum Ratings* may cause permanent damage to the device. These are stress ratings only, and functional operation of the device at these or any other conditions beyond those indicated under *Recommended Operating Conditions* is not implied. Exposure to absolute-maximum-rated conditions for extended periods may affect device reliability.
- (2) All voltage values, except differential voltages, are with respect to network ground.
- (3) Differential voltages are at IN+ with respect to IN-.
- (4) Short circuits from outputs to V_{CC} can cause excessive heating and eventual destruction.

6.2 ESD Ratings

	VALUE	UNIT
V _(ESD) Electrostatic discharge	Human body model (HBM), per ANSI/ESDA/JEDEC JS-001 ⁽¹⁾	1000
	Charged-device model (CDM), per JEDEC specification JESD22-C101 ⁽²⁾	750

- (1) JEDEC document JEP155 states that 500-V HBM allows safe manufacturing with a standard ESD control process.
- (2) JEDEC document JEP157 states that 250-V CDM allows safe manufacturing with a standard ESD control process.

6.3 Recommended Operating Conditions

over operating free-air temperature range (unless otherwise noted)

	MIN	MAX	UNIT
V _{CC} (non-V devices)	2	30	V
V _{CC} (V devices)	2	32	V
T _J Junction Temperature	-40	125	°C

6.4 Thermal Information

THERMAL METRIC ⁽¹⁾	XLx93, XL2903							UNIT
	D (SOIC)	DGK (VSSOP)	P (PDIP)	PS (SO)	PW (TSSOP)	JG (GDIP)	FK (LCCC)	
	8 PINS	8 PINS	8 PINS	8 PINS	8 PINS	8 PINS	20 PINS	
R _{θJA} Junction-to-ambient thermal resistance	97	172	85	95	149	—	—	°C/W
R _{θJC(top)} Junction-to-case (top) thermal resistance	—	—	—	—	—	14.5	5.61	°C/W

- (1) For more information about traditional and new thermal metrics, see the *Semiconductor and IC Package Thermal Metrics* application report, [SPRA953](#).

XL193 SOP8/XL293D-8/XL393 SOP8/XL2903 SOP8 XD293 DIP8/XD393 DIP8 XD2903 DIP8

6.5 Electrical Characteristics for XL193/XL293/XL393

at specified free-air temperature, $V_{CC} = 5\text{ V}$ (unless otherwise noted)

PARAMETER	TEST CONDITIONS	$T_A^{(1)}$	XL193			XL293 XL393			UNIT	
			MIN	TYP	MAX	MIN	TYP	MAX		
V_{IO} Input offset voltage	$V_{CC} = 5\text{ V to }30\text{ V}$, $V_{IC} = V_{ICR}\text{ min}$, $V_O = 1.4\text{ V}$	25°C		2	5		2	5	mV	
		Full range			9			9		
I_{IO} Input offset current	$V_O = 1.4\text{ V}$	25°C		3	25		5	50	nA	
		Full range			100			250		
I_{IB} Input bias current	$V_O = 1.4\text{ V}$	25°C		-25	-100		-25	-250	nA	
		Full range			-300			-400		
V_{ICR} Common-mode input-voltage range ⁽²⁾		25°C		0 to $V_{CC} - 1.5$		0 to $V_{CC} - 1.5$			V	
		Full range		0 to $V_{CC} - 2$		0 to $V_{CC} - 2$				
A_{VD} Large-signal differential-voltage amplification	$V_{CC} = 15\text{ V}$, $V_O = 1.4\text{ V to }11.4\text{ V}$, $R_L \geq 15\text{ k}\Omega\text{ to }V_{CC}$	25°C		50	200		50	200	V/mV	
I_{OH} High-level output current	$V_{OH} = 5\text{ V}$	$V_{ID} = 1\text{ V}$	25°C		0.1		0.1	50	nA	
	$V_{OH} = 30\text{ V}$	$V_{ID} = 1\text{ V}$	Full range					1	μA	
V_{OL} Low-level output voltage	$I_{OL} = 4\text{ mA}$, $V_{ID} = -1\text{ V}$	25°C		150	400		150	400	mV	
		Full range			700			700		
I_{OL} Low-level output current	$V_{OL} = 1.5\text{ V}$, $V_{ID} = -1\text{ V}$	25°C		6			6		mA	
I_{CC} Supply current	$R_L = \infty$	$V_{CC} = 5\text{ V}$	25°C		0.8	1		0.8	1	mA
		$V_{CC} = 30\text{ V}$	Full range			2.5			2.5	

- (1) Full range (minimum or maximum) for XL193 is -55°C to 125°C , for XL293 is 25°C to 85°C , and for XL393 is 0°C to 70°C . All characteristics are measured with zero common-mode input voltage, unless otherwise specified.
- (2) The voltage at either input or common-mode should not be allowed to go negative by more than 0.3 V . The upper end of the common-mode voltage range is $V_{CC+} - 1.5\text{ V}$ for the inverting input (-), and the non-inverting input (+) can exceed the V_{CC} level; the comparator provides a proper output state. Either or both inputs can go to 30 V without damage.

XL193 SOP8/XL293D-8/XL393 SOP8/XL2903 SOP8 XD293 DIP8/XD393 DIP8 XD2903 DIP8

6.6 Electrical Characteristics for XL193/XL293/XL393

at specified free-air temperature, $V_{CC} = 5\text{ V}$ (unless otherwise noted)

PARAMETER	TEST CONDITIONS	T_A ⁽¹⁾	XL293 XL393			UNIT
			MIN	TYP	MAX	
V_{IO} Input offset voltage	$V_{CC} = 5\text{ V to } 30\text{ V}, V_O = 1.4\text{ V}$ $V_{IC} = V_{ICR(min)}$	25°C		1	2	mV
		Full range			4	
I_{IO} Input offset current	$V_O = 1.4\text{ V}$	25°C		5	50	nA
		Full range			150	
I_{IB} Input bias current	$V_O = 1.4\text{ V}$	25°C		-25	-250	nA
		Full range			-400	
V_{ICR} Common-mode input-voltage range ⁽²⁾		25°C		0 to $V_{CC} - 1.5$		V
		Full range		0 to $V_{CC} - 2$		
A_{VD} Large-signal differential-voltage amplification	$V_{CC} = 15\text{ V}, V_O = 1.4\text{ V to } 11.4\text{ V},$ $R_L \geq 15\text{ k}\Omega\text{ to } V_{CC}$	25°C		50	200	V/mV
I_{OH} High-level output current	$V_{OH} = 5\text{ V}, V_{ID} = 1\text{ V}$	25°C		0.1	50	nA
	$V_{OH} = 30\text{ V}, V_{ID} = 1\text{ V}$	Full range			1	μA
V_{OL} Low-level output voltage	$I_{OL} = 4\text{ mA}, V_{ID} = -1\text{ V}$	25°C		150	400	mV
		Full range			700	
I_{OL} Low-level output current	$V_{OL} = 1.5\text{ V}, V_{ID} = -1\text{ V},$	25°C		6		mA
I_{CC} Supply current (four comparators)	$R_L = \infty$	25°C		0.8	1	mA
		Full range			2.5	

- (1) Full range (minimum or maximum) for XL293 is 25°C to 85°C, and for XL393 is 0°C to 70°C. All characteristics are measured with zero common-mode input voltage, unless otherwise specified.
- (2) The voltage at either input or common-mode should not be allowed to go negative by more than 0.3 V. The upper end of the common-mode voltage range is $V_{CC+} - 1.5\text{ V}$, but either or both inputs can go to 30 V without damage.

XL193 SOP8/XL293D-8/XL393 SOP8/XL2903 SOP8 XD293 DIP8/XD393 DIP8 XD2903 DIP8

6.7 Electrical Characteristics for XL2903 and XL2903K

at specified free-air temperature, $V_{CC} = 5\text{ V}$ (unless otherwise noted)

PARAMETER	TEST CONDITIONS	T_A ⁽¹⁾	XL2903			XL2903K			UNIT	
			MIN	TYP	MAX	MIN	TYP	MAX		
V_{IO} Input offset voltage	$V_{CC} = 5\text{ V to MAX}^{(2)}$, $V_O = 1.4\text{ V}$, $V_{IC} = V_{ICR(min)}$	25°C		2	7		1	2	mV	
		Full range			15			4		
I_{IO} Input offset current	$V_O = 1.4\text{ V}$	25°C		5	50		5	50	nA	
		Full range			200			200		
I_{IB} Input bias current	$V_O = 1.4\text{ V}$	25°C		-25	-250		-25	-250	nA	
		Full range			-500			-500		
V_{ICR} Common-mode input-voltage range ⁽³⁾		25°C		0 to $V_{CC} - 1.5$			0 to $V_{CC} - 1.5$		V	
		Full range		0 to $V_{CC} - 2$			0 to $V_{CC} - 2$			
A_{VD} Large-signal differential-voltage amplification	$V_{CC} = 15\text{ V}$, $V_O = 1.4\text{ V to } 11.4\text{ V}$, $R_L \geq 15\text{ k}\Omega\text{ to } V_{CC}$	25°C		25	100		25	100	V/mV	
I_{OH} High-level output current	$V_{OH} = 5\text{ V}$, $V_{ID} = 1\text{ V}$	25°C			0.1	50		0.1	50	nA
	$V_{OH} = V_{CC}\text{ MAX}^{(2)}$, $V_{ID} = 1\text{ V}$	Full range				1			1	μA
V_{OL} Low-level output voltage	$I_{OL} = 4\text{ mA}$, $V_{ID} = -1\text{ V}$	25°C			150	400		150	400	mV
		Full range				700			700	
I_{OL} Low-level output current	$V_{OL} = 1.5\text{ V}$, $V_{ID} = -1\text{ V}$	25°C		6			6		mA	
I_{CC} Supply current	$R_L = \infty$	$V_{CC} = 5\text{ V}$	25°C		0.8	1		0.8	1	mA
		$V_{CC} = \text{MAX}$	Full range			2.5			2.5	

- (1) Full range (minimum or maximum) for XL2903 is -40°C to 125°C . All characteristics are measured with zero common-mode input voltage, unless otherwise specified.
- (2) $V_{CC}\text{ MAX} = 30\text{ V}$ for non-V devices and 32 V for V-suffix devices.
- (3) The voltage at either input or common-mode should not be allowed to go negative by more than 0.3 V . The upper end of the common-mode voltage range is $V_{CC+} - 1.5\text{ V}$, but either or both inputs can go to 30 V (32 V for V-suffix devices) without damage.

6.8 Switching Characteristics

$V_{CC} = 5\text{ V}$, $T_A = 25^\circ\text{C}$

PARAMETER	TEST CONDITIONS	XL2903, XL293, XL393		UNIT
		TYP		
Response time	R_L connected to 5 V through $5.1\text{ k}\Omega$, $C_L = 15\text{ pF}^{(1)(2)}$	100-mV input step with 5-mV overdrive		1.3
		TTL-level input step		0.3

- (1) C_L includes probe and jig capacitance.
- (2) The response time specified is the interval between the input step function and the instant when the output crosses 1.4 V .

XL193 SOP8/XL293D-8/XL393 SOP8/XL2903 SOP8 XD293 DIP8/XD393 DIP8 XD2903 DIP8

6.9 Typical Characteristics

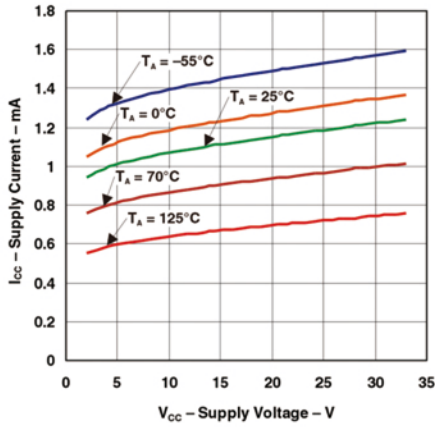


Figure 1. Supply Current vs Supply Voltage

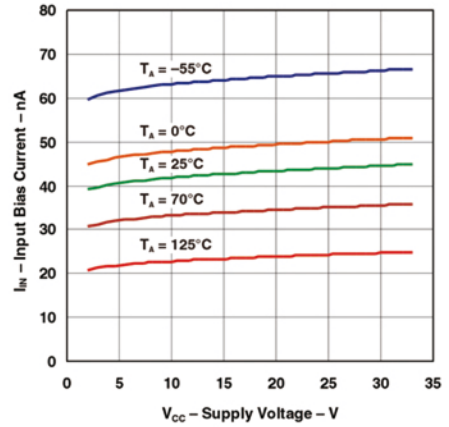


Figure 2. Input Bias Current vs Supply Voltage

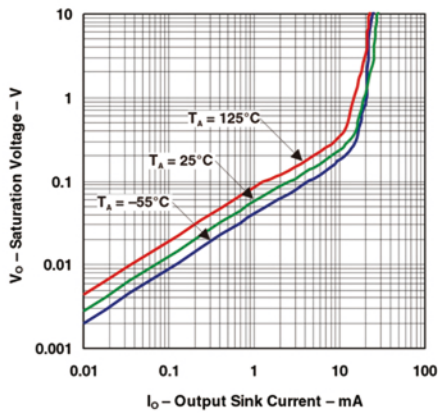


Figure 3. Output Saturation Voltage

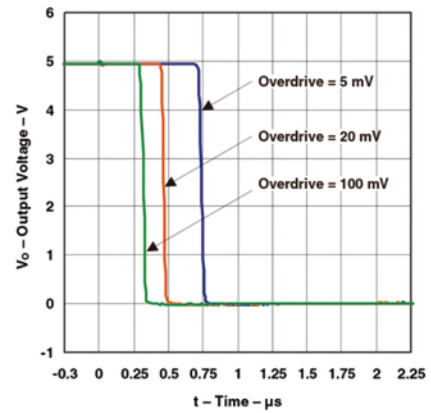


Figure 4. Response Time for Various Overdrives Negative Transition

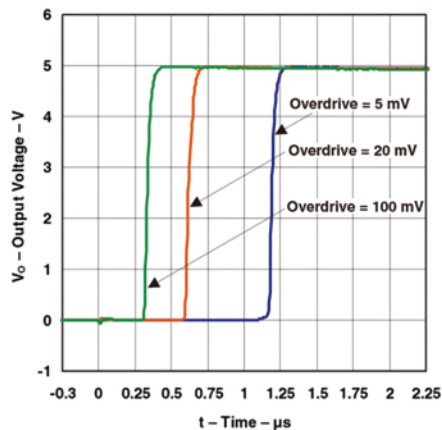


Figure 5. Response Time for Various Overdrives Positive Transition

XL193 SOP8/XL293D-8/XL393 SOP8/XL2903 SOP8 XD293 DIP8/XD393 DIP8 XD2903 DIP8

7 Detailed Description

7.1 Overview

The XL2903 is a dual comparator with the ability to operate up to 36 V on the supply pin. This standard device has proven ubiquity and versatility across a wide range of applications. This is due to very wide supply voltages range (2 V to 36 V), low I_q and fast response of the devices.

The open-drain output allows the user to configure the output's logic low voltage (V_{OL}) and can be used to enable the comparator to be used in AND functionality.

7.2 Functional Block Diagram

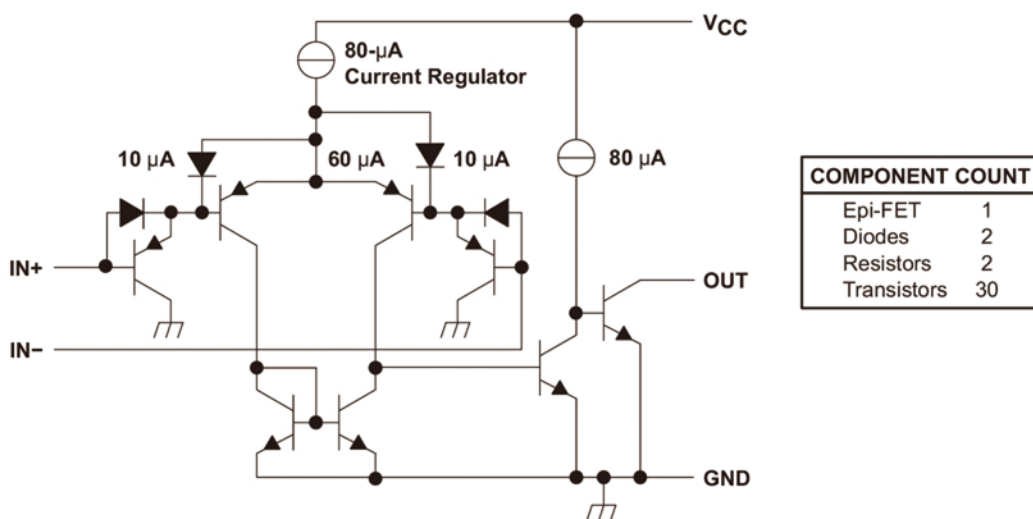


Figure 6. Schematic (Each Comparator)

7.3 Feature Description

XL2903 consists of a PNP darlington pair input, allowing the device to operate with very high gain and fast response with minimal input bias current. The input Darlington pair creates a limit on the input common mode voltage capability, allowing XL2903 to accurately function from ground to $V_{CC}-1.5V$ differential input. This enables much head room for modern day supplies of 3.3 V and 5 V.

The output consists of an open drain NPN (pull-down or low side) transistor. The output NPN will sink current when the positive input voltage is higher than the negative input voltage and the offset voltage. The V_{OL} is resistive and will scale with the output current. See Figure 3 for V_{OL} values with respect to the output current.

7.4 Device Functional Modes

7.4.1 Voltage Comparison

The XL2903 operates solely as a voltage comparator, comparing the differential voltage between the positive and negative pins and outputting a logic low or high impedance (logic high with pullup) based on the input differential polarity.

8 Application and Implementation

8.1 Application Information

XL2903 will typically be used to compare a single signal to a reference or two signals against each other. Many users take advantage of the open drain output to drive the comparison logic output to a logic voltage level to an MCU or logic device. The wide supply range and high voltage capability makes LM2903 optimal for level shifting to a higher or lower voltage.

8.2 Typical Application

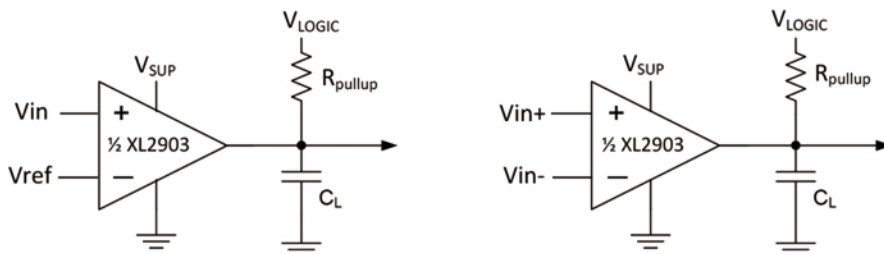


Figure 7. Single-Ended and Differential Comparator Configurations

8.2.1 Design Requirements

For this design example, use the parameters listed in [Table 1](#) as the input parameters.

Table 1. Design Parameters

DESIGN PARAMETER	EXAMPLE VALUE
Input Voltage Range	0 V to $V_{sup}-1.5$ V
Supply Voltage	2 V to 36 V
Logic Supply Voltage	2 V to 36 V
Output Current (R_{PULLUP})	1 μ A to 20 mA
Input Overdrive Voltage	100 mV
Reference Voltage	2.5 V
Load Capacitance (C_L)	15 pF

8.2.2 Detailed Design Procedure

When using XL2903 in a general comparator application, determine the following:

- Input Voltage Range
- Minimum Overdrive Voltage
- Output and Drive Current
- Response Time

8.2.2.1 Input Voltage Range

When choosing the input voltage range, the input common mode voltage range (V_{ICR}) must be taken in to account. If temperature operation is above or below 25°C the V_{ICR} can range from 0 V to $V_{CC}-2.0$ V. This limits the input voltage range to as high as $V_{CC}-2.0$ V and as low as 0 V. Operation outside of this range can yield incorrect comparisons.

Below is a list of input voltage situation and their outcomes:

1. When both IN- and IN+ are both within the common-mode range:
 - (a) If IN- is higher than IN+ and the offset voltage, the output is low and the output transistor is sinking current
 - (b) If IN- is lower than IN+ and the offset voltage, the output is high impedance and the output transistor is not conducting
2. When IN- is higher than common-mode and IN+ is within common-mode, the output is low and the output transistor is sinking current
3. When IN+ is higher than common-mode and IN- is within common-mode, the output is high impedance and the output transistor is not conducting
4. When IN- and IN+ are both higher than common-mode, the output is low and the output transistor is sinking current

8.2.2.2 Minimum Overdrive Voltage

Overdrive Voltage is the differential voltage produced between the positive and negative inputs of the comparator over the offset voltage (V_{IO}). In order to make an accurate comparison the Overdrive Voltage (V_{OD}) should be higher than the input offset voltage (V_{IO}). Overdrive voltage can also determine the response time of the comparator, with the response time decreasing with increasing overdrive. Figure 8 and Figure 9 show positive and negative response times with respect to overdrive voltage.

8.2.2.3 Output and Drive Current

Output current is determined by the load/pull-up resistance and logic/pullup voltage. The output current will produce a output low voltage (V_{OL}) from the comparator. In which V_{OL} is proportional to the output current. Use [Typical Characteristics](#) to determine V_{OL} based on the output current.

The output current can also effect the transient response. See [Response Time](#) for more information.

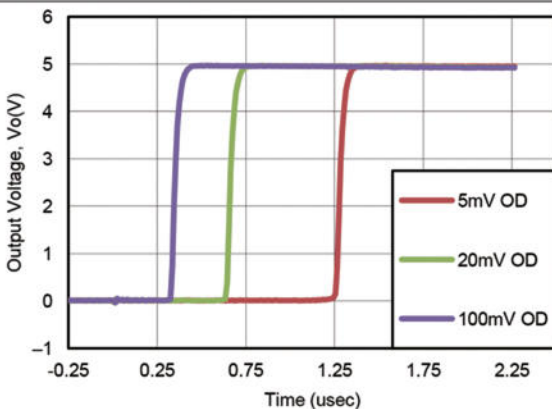
8.2.2.4 Response Time

The transient response can be determined by the load capacitance (C_L), load/pullup resistance (R_{PULLUP}) and equivalent collector-emitter resistance (R_{CE}).

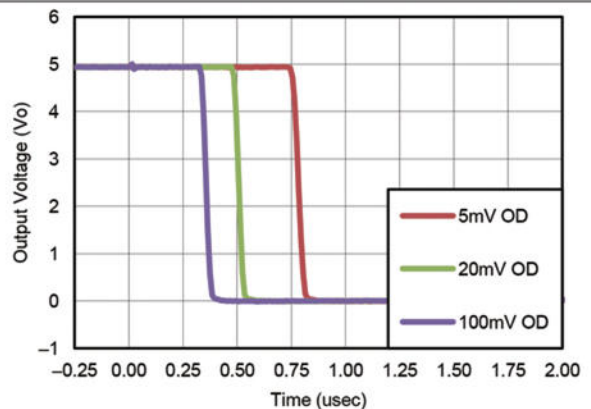
- The positive response time (τ_P) is approximately $\tau_P \sim R_{PULLUP} \times C_L$
- The negative response time (τ_N) is approximately $\tau_N \sim R_{CE} \times C_L$
 - R_{CE} can be determine by taking the slope of [Typical Characteristics](#) in it's linear region at the desired temperature, or by dividing the V_{OL} by I_{out}

8.2.3 Application Curves

The following curves were generated with 5 V on V_{CC} and V_{Logic} , $R_{PULLUP} = 5.1 \text{ k}\Omega$, and 50 pF scope probe.

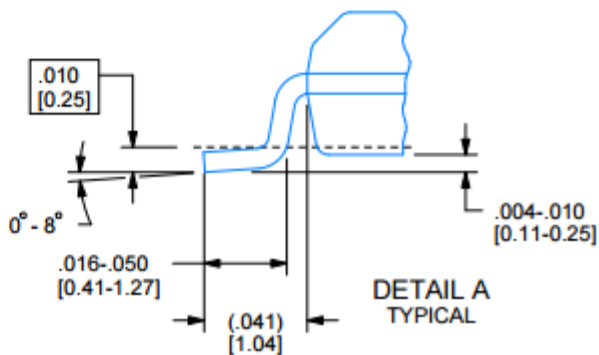
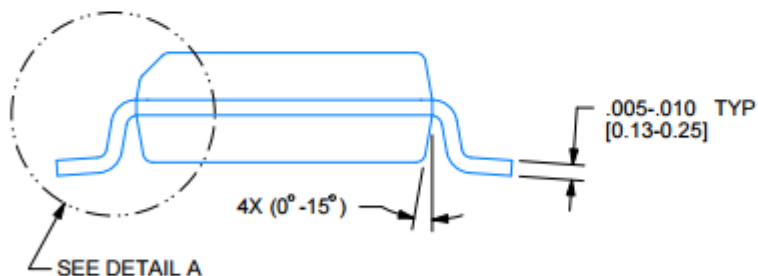
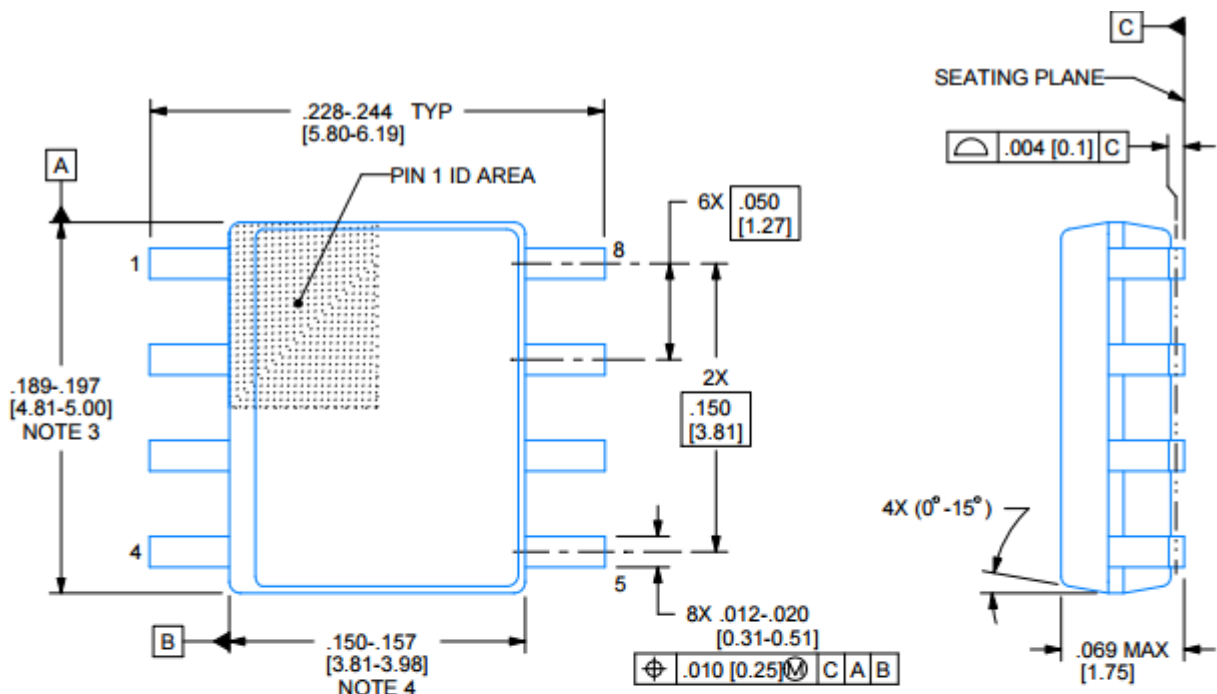


**Figure 8. Response Time for Various Overdrives
(Positive Transition)**

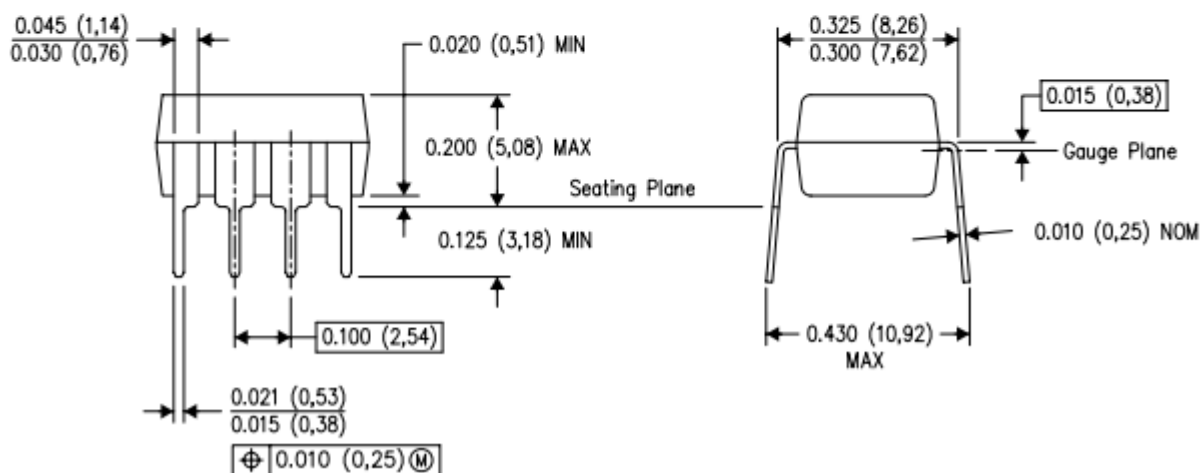
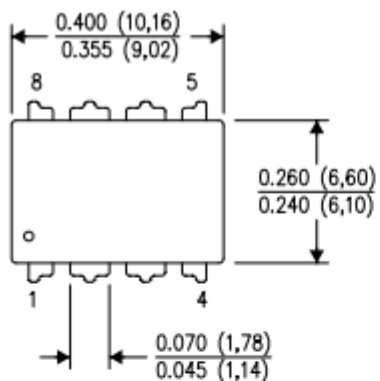


**Figure 9. Response Time for Various Overdrives
(Negative Transition)**

**XL193 SOP8/XL293D-8/XL393 SOP8/XL2903 SOP8
XD293 DIP8/XD393 DIP8 XD2903 DIP8**



**XL193 SOP8/XL293D-8/XL393 SOP8/XL2903 SOP8
XD293 DIP8/XD393 DIP8 XD2903 DIP8**



以上信息仅供参考. 如需帮助联系客服人员. 谢谢 XINLU DA