

ITEM P/N	PSPMAA0603-4R7M-ANF	TEST INSTRUMENT	Zentech-3305 / Zentech502BC
PRODUCT	SMD Inductor	TEST FREQUENCY	100 kHz / 1.0V

**CUSTOMER :****CUSTOMER P/N :****DESCRIPTION :** SMD INDUCTOR**P/N :** PSPMAA0603-4R7M-ANF**REVISION NO. :** Version: 2.0**DATE :** 2017/4/19**NOTES :** STANDARD

DOCUMENTED	
APPROVED	Kevin
CHECKED	Peter
PREPARED	Ben

**CUSTOMER APPROVAL**

company seals

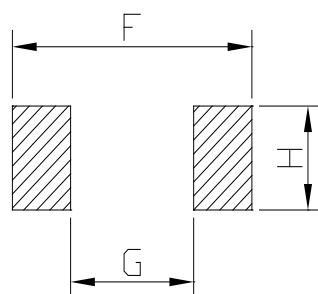
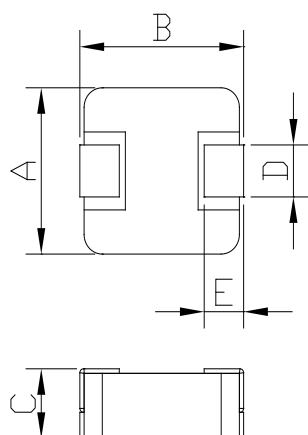

ITEM P/N	PSPMAA0603-4R7M-ANF	TEST INSTRUMENT	Zentech-3305 / Zentech502BC
PRODUCT	SMD Inductor	TEST FREQUENCY	100 kHz / 1.0V

**PACKING DIMENSIONS (mm)**RECOMMANED  
LAND PATTERN

0603	Dimensions
A	6.6 ± 0.3
B	7.1 ± 0.3
C	3.0 MAX
D	3.0 ± 0.3
E	1.6 ± 0.5
F	7.4 Typ
G	3.7 Typ
H	3.5 Typ

**EXPLANATION OF PART NUMBERS**

<b>P S P M A A</b>	<b>0 6 0 3</b>	-	<b>4 R 7 M</b>	-	<b>A N F</b>
<u>Serial Codes</u>	<u>Size</u>		<u>Inductance</u>		<u>Description</u>

**ELECTRICAL CHARACTERISTICS**

ITEM P/N	@ 26 °C Ambient Temperture				DCR mΩ @ 25°C Typical	DCR mΩ @ 25°C MAX
	INDUCTANCE		Typical Heat Rating DC Current (A) (I <sub>dc</sub> )	Typical Saturation DC Current (A) (I <sub>sat</sub> )		
	Lo (μH)	TOLERANCE				
PSPMAA060 3-4R7M-ANF	4.7	±20%	5.5	10	37	40

- ⊙ All test Data is referenced to 25°C ambient
- ⊙ Typical Heat Rating DC Current would cause an approximately ΔT of 40°C
- ⊙ Typical Saturation DC Current would cause Lo to drop approximately 35%
- ⊙ Operation Temperature Range : -55°C ~ 125°C
- ⊙ The Part temperature (ambient + ΔT) should not exceed 125°C under worst case operating conditions.
- ⊙ Circuit design, component placement, PWB trace size and thickness, airflow and other cooling provisions all effect the part temperature. Part temperature should be verified in the end application.

ITEM P/N	PSPMAA0603-4R7M-ANF	TEST INSTRUMENT	Zentech-3305 / Zentech502BC
PRODUCT	SMD Inductor	TEST FREQUENCY	100 kHz / 1.0V

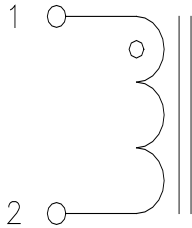
**CONNECTIONS****MARKING**

- ⊙ Inductor Contents ONE (1) Set(s) of Coil
- ⊙ DC/AC Current Shall Be Introduced By Any One of Two Pads

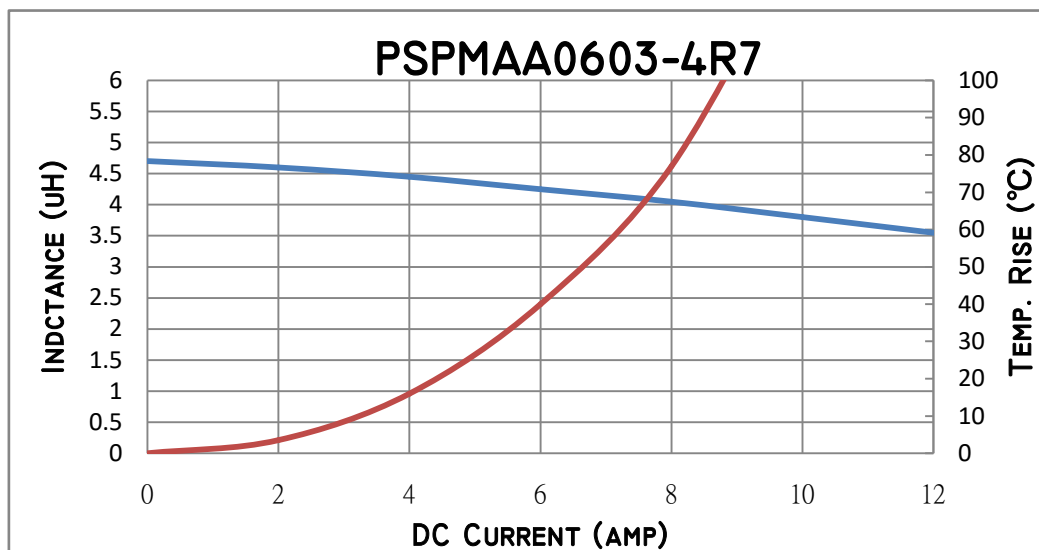
**PERFORMANCE CURVES****RECOMMENDED SOLDERING TEMP. GRAPH**

TEMPERATURE (°C)

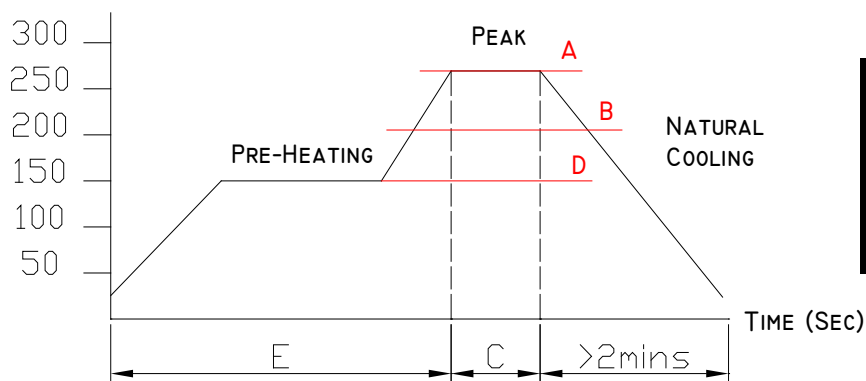

Page: 2

ITEM P/N	PSPMAA0603-4R7M-ANF	TEST INSTRUMENT	Zentech-3305 / Zentech502BC
PRODUCT	SMD Inductor	TEST FREQUENCY	100 kHz / 1.0V

**MECHANICAL RELIABILITY**

TEST	Specification & Requirement	Method Used
Solderability	The surface of terminal/pin tested shall be covered with new solder by 95%	Solder heat proof: Preheating: 180 ±10°C 90 seconds Soldering: 255 ±5°C for 3 ±1 sec
Shock	Inductance change within ± 5% Without mechanical damage	Drop down with 981m/s <sup>2</sup> (100G) shock Attitude upon a rubber block method shock testing machinem, 3 tests.
Vibration	Inductance change within ± 5% Without mechanical damage	Vibration frequency: 10Hz to 55Hz to 10Hz 60 seconds cycle Vibration time: 2 hours

**ENDURANCE RELIABILITY**

TEST	Specification & Requirement	Method Used
Thermal Shock	Inductance change within ± 5% Without mechanical damage	-25°C, (30 mins) -> room temp. (5 mins) -> 125°C, (30 mins) -> room temp. (5 mins) 100 cycles
Heat Resistance	Inductance change within ± 5% Without mechanical damage	Apply IDC current @ 85°C ambient Duration: 1000 hrs
Humidity Resistance	Inductance change within ± 5% Without mechanical damage	Apply IDC current @ 60°C ambient Humidity: 90~95% Duration: 1000 hrs
Low Temp. Storing	Inductance change within ± 5% Without mechanical damage	Storing Temp. -25 ±2 °C for total 1,000 +4/-0 hours
High Temp. Storing	Inductance change within ± 5% Without mechanical damage	Storing Temp. 125 ±2 °C for total 1,000 +4/-0 hours

# PACKING FOR SMD

**RoHS  
COMPLIANT**

ITEM P/N	PSPMAA0603-4R7M-ANF	TEST INSTRUMENT	Zentech-3305 / Zentech502BC
PRODUCT	SMD Inductor	TEST FREQUENCY	100 kHz / 1.0V

**CARRIERTAPEING REEL & CARRIER MATERIALS (PAPER PLASTICS) UNIT : (mm)**

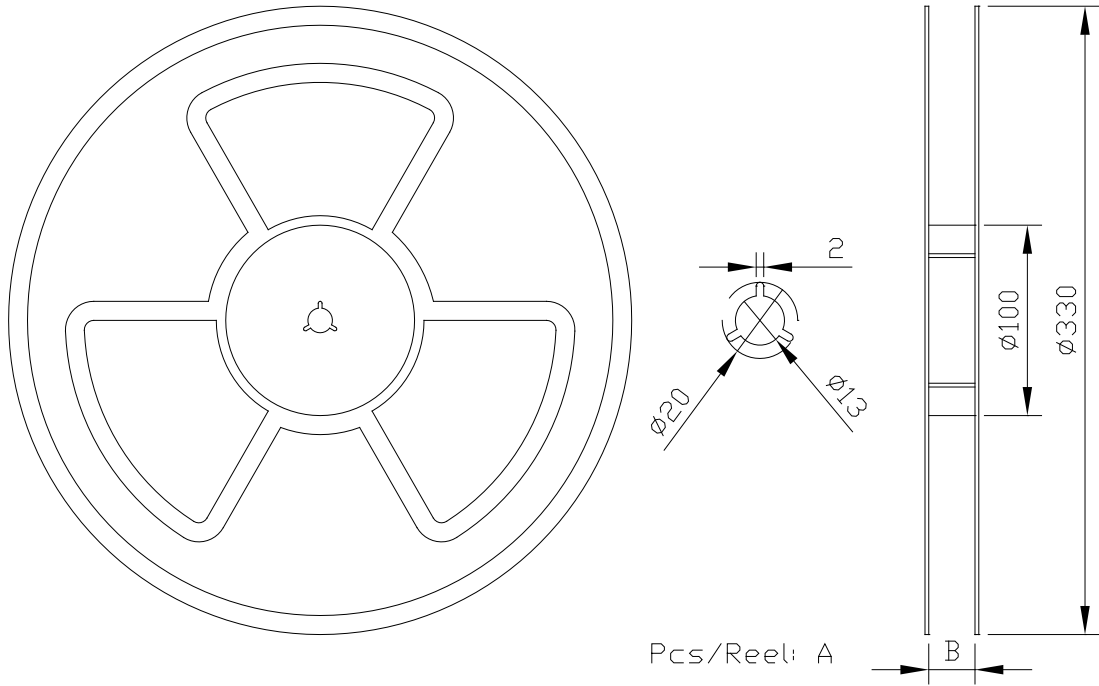

A	B	Ao	Bo	Ko
1000	17	6.9 ± 0.1	7.6 ± 0.1	3.4 ± 0.1

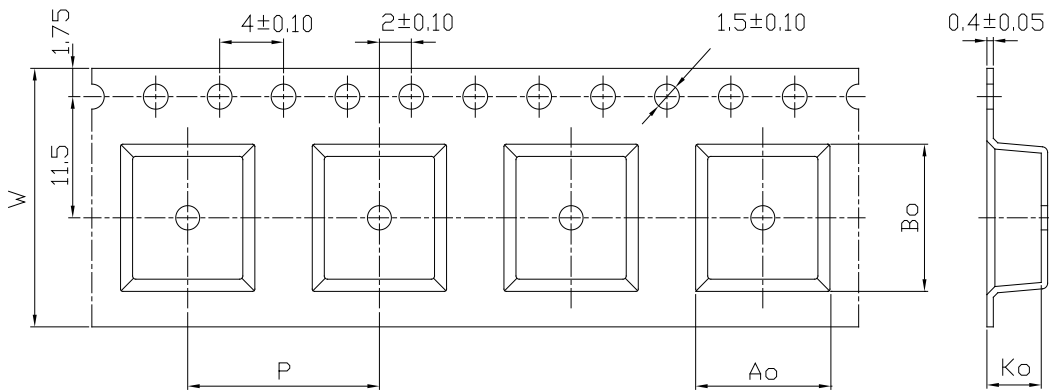

W	P
16	12

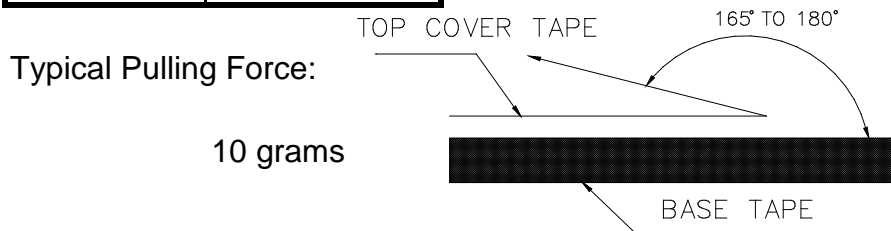

ITEM P/N	PSPMAA0603-4R7M-ANF	TEST INSTRUMENT	Zentech-3305 / Zentech502BC
PRODUCT	SMD Inductor	TEST FREQUENCY	100 kHz / 1.0V

**TEST DATA**

SPEC No.	A (mm)	B (mm)	C (mm)	D (mm)	E (mm)			DCR	INDUCTANCE	
	6.6 ± 0.3	7.1 ± 0.3	3.0 MAX	3.0 ± 0.3	1.6 ± 0.5			Max( mΩ )	L(0) ± 20%	10 A
								40	4.70	≈ 65% L(0)
1	6.72	7.25	2.95	2.95	1.88			38.1	4.47	PASS
2	6.75	7.28	2.88	2.94	1.84			38.5	4.52	PASS
3	6.73	7.22	2.97	2.95	1.86			38.6	4.81	PASS
4	6.72	7.26	2.86	2.95	1.85			38.6	4.66	PASS
5	6.73	7.28	2.88	2.94	1.85			38.5	4.45	PASS
6	6.76	7.25	2.84	2.95	1.85			38.6	4.61	PASS
7	6.71	7.22	2.93	2.95	1.84			38.8	4.65	PASS
8	6.75	7.21	2.92	2.95	1.86			39.1	4.88	PASS
9	6.78	7.25	2.87	2.94	1.86			38.7	4.92	PASS
10	6.73	7.31	2.84	2.94	1.84			39.2	4.71	PASS
$\bar{X}$	6.74	7.25	2.89	2.95	1.85	0.00		38.67	4.67	
R	0.07	0.10	0.13	0.01	0.04	0.00		1.10	0.47	

© All test Data is referenced to 25°C ambient



# ANNOUNCEMENTS

## 产品注意事项

使用本产品时，请注意以下事项

- ◎ 产品保存期限为12个月，保存条件：温度5~40℃，湿度10~80%RH以内，超过保存期限可能会使产品端子电极发生氧化。
- ◎ 请勿在极端环境下使用和保存（高盐，强酸，强碱，强辐射等）。
- ◎ 产品焊接前，请进行预热；预热温度与焊接温度之间温差建议控制在150℃以内。
- ◎ 产品焊接后需重新拆卸焊接修正时，请遵循规格书规定的条件范围；过高的加热温度以及反复的拆卸可能会导致产品失效。
- ◎ 产品焊接到线路板后，请注意不可因线路板整体变形或局部变形而施加给电感剩余应力，这可能会导致电感发生破裂，脱落，以致失效。
- ◎ 产品请勿接触清洗剂，酒精等液体，这会侵蚀产品本体，从而导致产品失效。
- ◎ 产品通电后温度会随电流的增大而上升，设计时请务必考虑留有余量。
- ◎ 过高的静电会对产品产生永久性损害，请注意静电防护。
- ◎ 产品通电过程请勿触摸产品任何部位，防止触电。
- ◎ 本产品作为磁性产品，设计时请务必考虑周边元器件与本产品可能产生的相互影响。
- ◎ 本产品适用于一般电子设备，如：AV设备，通信设备，家电产品，娱乐设备，计算机设备，个人设备，办公设备，计测设备，工业机器人等。且该一般电子设备需在常规的操作和使用方法环境下使用。对于需要高度安全性和可靠性的，或者因本产品失效造成设备故障，误操作，运转不良等危及到人的生命身体及财产安全，以及对社会产生较大不良影响的特殊用途，设计使用前务必同本公司沟通，设计使用者如在未取得我司书面同意状况下使用造成任何后果，我司不予承担。特殊用途包含但不限于如下清单：

- |                       |                  |
|-----------------------|------------------|
| 1 军用设备                | 8 关系到国防安全的设备     |
| 2 运输设备（汽车，轨道交通产品，船舶等） | 9 防灾赈灾设备         |
| 3 航空，航天设备             | 10 各种安规设备        |
| 4 发电控制设备              | 11 紧急救护设备        |
| 5 核动力相关设备             | 12 其他被认定为特殊用途的设备 |
| 6 爆炸引燃控制设备            |                  |
| 7 交通控制设备              |                  |

Page: 6



PROD TECHNOLOGY CO., LTD.



E-LIVEN TECHNOLOGY CO., LTD.  
NO. 28 HO-CHENG RD, BADE CITY, TAOYUAN, TAIWAN