

GBD-C171TBKT-DZ

0805 贴片式发光二极管

0805 Chip Light Emitting Diode

技术数据表 Technical Data Sheet

本产品主要作为信号指示及照明的电子元件广泛应用于各类使用表面贴装结构的电子产品中,如家用电器的开关指示灯、手机键盘灯、汽车仪表盘照明等。本产品也广泛用作液晶显示屏(LCD)的背光源。

This product is generally used as indicator and illumination for electronic equipment such as household appliance, communication equipment, and dashboard. And it can also be used as flat backlight for Liquid Crystal Display (LCD).

特性:

Features:

- 管芯材料: InGaN
Material: InGaN
- 发光颜色: 蓝色
Emitting Color: Blue
- 光强度高, 功耗低
High Luminous Intensity and Low Power Dissipation
- 可靠性高, 寿命长
Good Reliability and Long Life
- 符合欧盟公布的 RoHS 指令要求
Complied With RoHS Directive

目录

Catalogue

电性参数	
Electrical Characteristics	2
典型特性曲线	
Typical Characteristic Curves	3
可靠性实验	
Reliability Test Items And Conditions.....	4
外形尺寸	
Outline Dimensions	5
包装	
Packaging	6
焊接指导	
Guideline for Soldering.....	8
使用注意事项	
Precautions	10

电性参数

Electrical Characteristics

◇ 极限参数 (温度=25℃):
Absolute Maximum Ratings (Temperature=25°C):

参数名称 Parameter	符号 Symbol	数值 Rating	单位 Unit
正向电流 Forward Current	I_F	25	mA
正向脉冲电流* Pulse Forward Current*	I_{FP}	80	mA
反向电压 Reverse Voltage	V_R	5	V
工作温度 Operating Temperature	T_{OPR}	-40 ~ +85	℃
贮存温度 Storage Temperature	T_{stg}	-40 ~ +85	℃
功耗 Power Dissipation	P_D	85	mW

* 注: 脉冲宽度 $\leq 0.1ms$, 占空比 $\leq 1/10$
 * Note: Pulse width $\leq 0.1ms$, Duty $\leq 1/10$

◇ 光电参数 (温度=25℃):
Electro-Optical Characteristics (Temperature=25°C):

参数名称 Parameter	符号 Symbol	条件 Condition	最小值 Min.	典型值 Typ.	最大值 Max.	单位 Unit
反向电流 Reverse Current	I_R	$V_R=5V$	-	-	10	μA
正向电压 Forward Voltage	V_F	$I_F=20mA$	2.7	3.0	3.4	V
主波长 Dominant Wavelength	λ_D		465	470	475	nm
半波宽度 Spectrum Radiation Bandwidth	$\Delta\lambda$		-	25	-	nm
光强 Luminous Intensity	I_V		70	110	180	mcd
视角 View Angle	$2\theta_{1/2}$		-	130	-	deg.

典型特性曲线

Typical Characteristics Curves

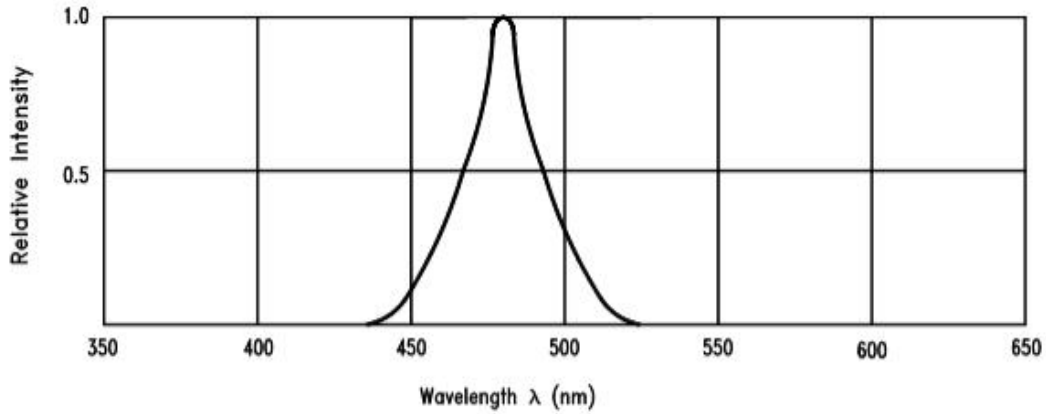

Fig.1 Relative Intensity vs. Wavelength

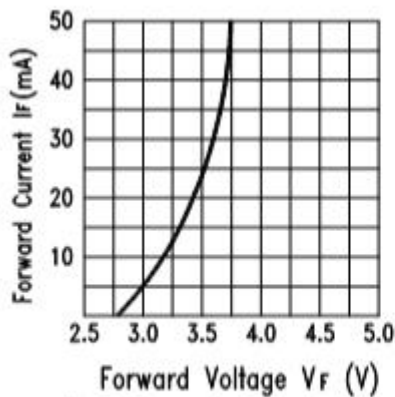

Fig.2 Forward Current vs. Forward Voltage

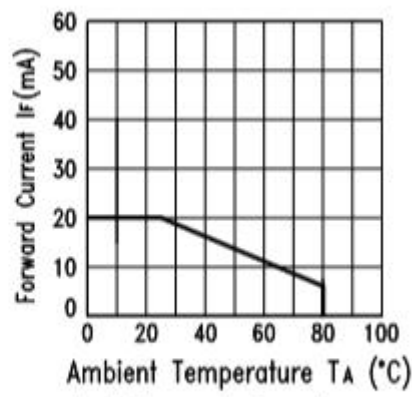

Fig.3 Forward Current Derating Curve

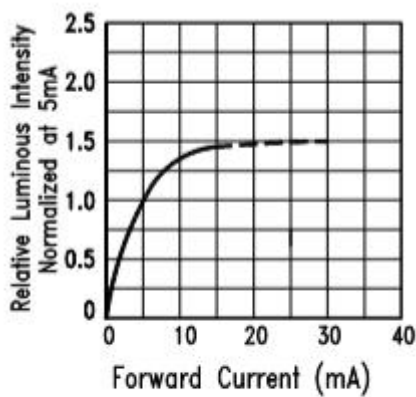

Fig.4 Relative Luminous Intensity vs. Forward Current

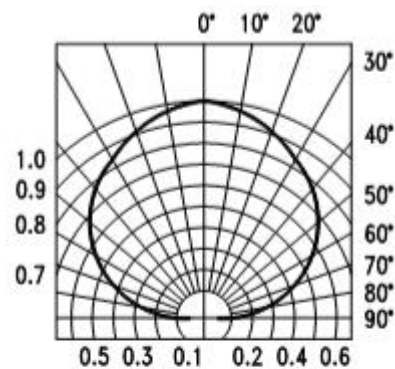



Fig.6 Spatial Distribution

可靠性试验

Reliability Test Items And Conditions

试验项目 Test Items	试验条件 Test Conditions	试验数量 Quantity	判断标准 Judging Criteria
可焊性试验 Solderability	焊接温度 (Solder Temperature): 300°C 焊接时间 (Solder Duration): (3.5±0.5) sec.	15	湿润良好 上锡面积在 95%以上 Solderable Area Over 95%
温度快速变化继之以 循环湿热 Thermal Shock Followed by High Temperature And High Humidity Cyclic	<p style="text-align: center;">-40°C → 10 min.</p> <p style="text-align: center;">5 次循环  转移 (2~3) min.</p> <p style="text-align: center;">5 Cycles Shift</p> <p style="text-align: center;">100°C → 10 min.</p> <p style="text-align: center;">↓</p> <p style="text-align: center;">25°C~55°C (90%~95%) RH 2 次循环 48 hrs., 恢复 2 hrs. 2 Cycles for 48 hrs., Recover for 2 hrs.</p>	11	C=0 & I**
耐焊接热试验 Resistance For Soldering Heat	红外回流焊法 Reflow Soldering	15	C=0 & I**
电耐久性试验 DC Operating Life	1000 hrs. 正向电流: 20mA Forward Current: 20mA	22	C=0 & I*
高温贮存试验 High Temperature Storage	100°C → 1000 hrs.	15	C=0 & I*
循环湿热 High Temperature And High Humidity Cyclic	25°C~55°C (90%~95%) RH 6 次循环 144 hrs., 恢复 2 hrs. 6 Cycles for 144 hrs., Recover for 2 hrs.	11	C=0 & I*

*1 失效判断标准 Criteria For Judging Damage

测试项目 Items	符号 Symbol	测试条件 Test Conditions	失效判断标准 I* Criteria For Judging Damage I*	失效判断标准 I** Criteria For Judging Damage I**
正向电压 Forward Voltage	V _F	I _F =20mA	≥USL×1.2	≥USL
反向电流 Reverse Current	I _R	V _R =5V	≥USL×2.0	≥USL
光强 Luminous Intensity	I _V	I _F =20mA	≤LSL×0.5	≤LSL

* USL: 标准值上限值, LSL: 标准值下限值

* USL: Upper Standard Level, LSL: Lower Standard Level

外形尺寸

Outline Dimension

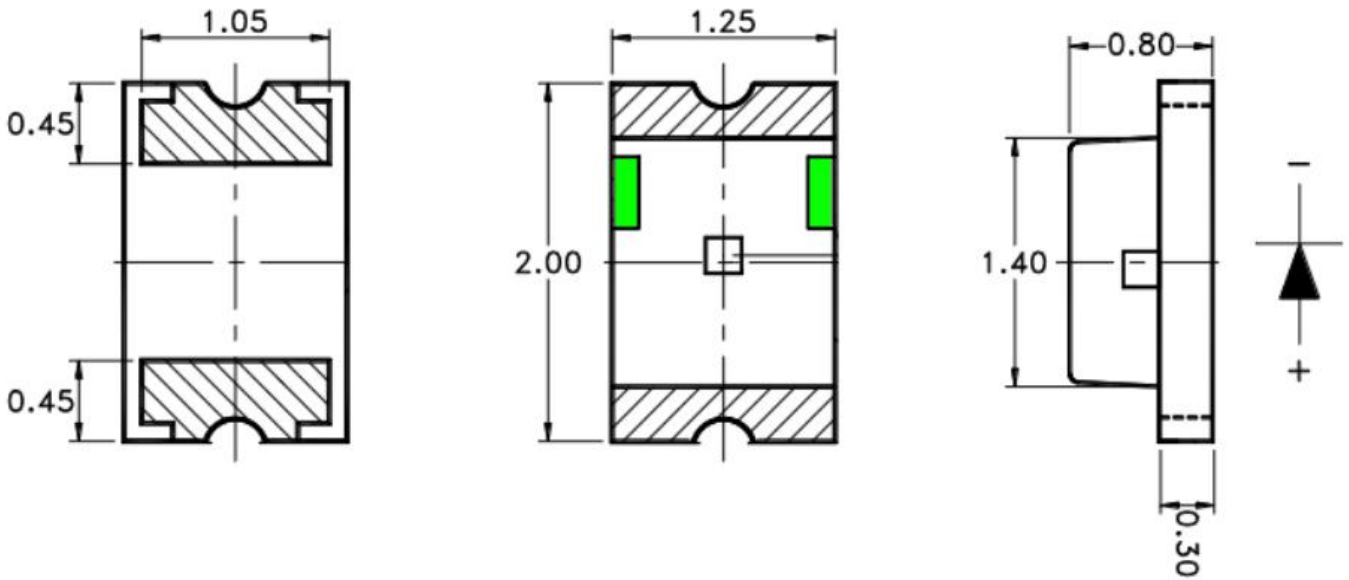

推荐焊盘图:

Suggest Soldering Pad Dimensions:

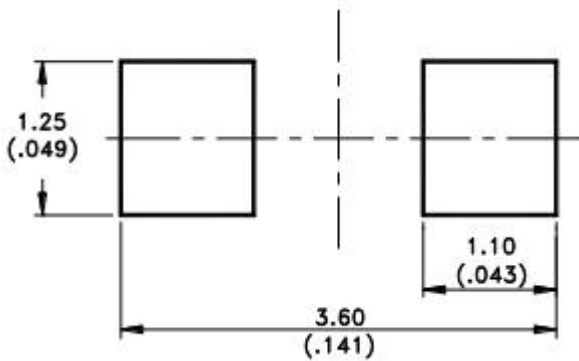

敷铜区域:	
Copper Area:	
阻焊丝印区域:	
Solder Resist:	
*无特别规定时, 公差为 $\pm 0.1\text{mm}$, 单位为 mm *	
* The Tolerances Unless Mentioned is $\pm 0.1\text{mm}$. Unit= mm *	

包装 (2)

Packaging (2)

◇ 防潮防静电包装 Moisture Proof and Anti-Electrostatic Foil Bag

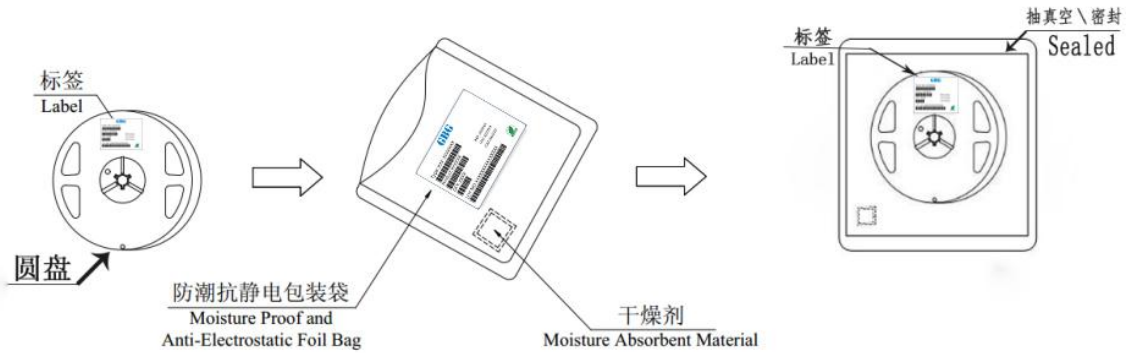

◇ 外包装箱 Cardboard Box

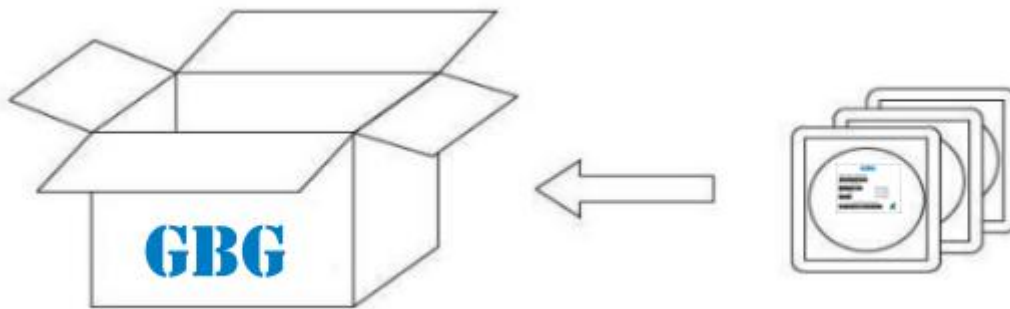

◇ 标签说明 Label Explanation

- Type: 产品型号
- LOT NO: 批号 Lot Number
- QTY: 数量 Quantity
- REF: 正向电压范围 Forward Voltage Range
- HUE: 波长范围 Wavelength Range
- CAT: 光强范围 Luminous Intensity Range



焊接指导 (1)

Guideline for Soldering (1)

1. 使用烙铁人手焊接

Hand Soldering

推荐使用功率低于 20W 的烙铁，焊接时烙铁的温度必须保持在 300℃ 以下，且每个电极只能进行一次焊接，每次焊接的持续时间不得超过 3 秒。

人手焊接过程中的不慎操作易引起 LED 产品的损坏，应当小心谨慎。

A soldering iron of less than 20W is recommended to be used in Hand Soldering. Please keep the temperature of the soldering iron under 300℃ while soldering. Each terminal of the LED is to go for less than 3 second and for one time only.

Be careful because the damage of the product is often started at the time of the hand soldering.

2. 回流焊接：推荐使用以下无铅回流焊接温度图进行。

Reflow Soldering: Use the conditions shown in the under Figure of Pb-Free Reflow Soldering.

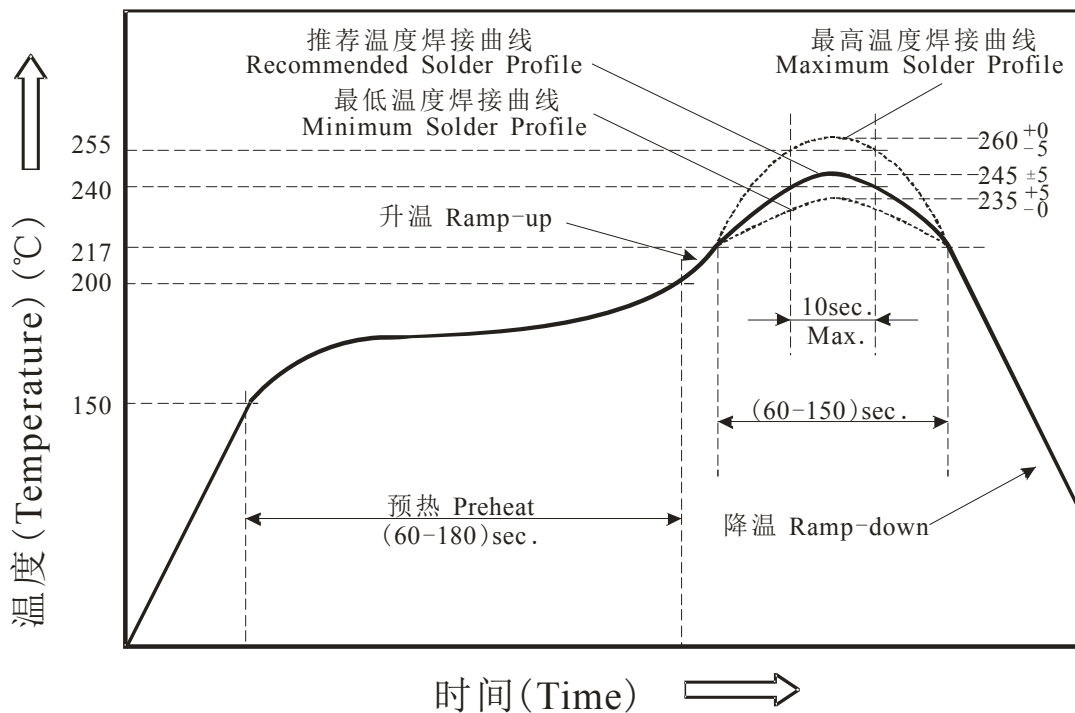

- 回流焊接最多只能进行两次。

Reflow soldering should not be done more than two times.

- 在回流焊接升温过程中，请不要对 LED 施加任何压力。

Stress on the LEDs should be avoided during heating in soldering process.

- 在焊接完成后，待产品温度下降到室温之后，再进行其他处理。

After soldering, do not deal with the product before its temperature drop down to room temperature.

焊接指导 (2)

Guideline for Soldering (2)

3. 清洗:

Cleaning

在焊接后推荐使用酒精进行清洗，在温度不高于 30°C 的条件下持续 3 分钟，不高于 50°C 的条件下持续 30 秒。使用其他类似溶剂清洗前，请先确认使用的溶剂不会对 LED 的封装和环氧树脂部分造成损伤。

超声波清洗也是有效的方法，一般最大功率不应超过 300W，否则可能对 LED 造成损伤。请根据具体的情况预先测试清洗条件是否会对 LED 造成损伤。

It is recommended that alcohol be used as a solvent for cleaning after soldering. Cleaning is to go under 30°C for 3 minutes or 50°C for 30 seconds. When using other solvents, it should be confirmed beforehand whether the solvents will dissolve the package and the resin or not.

Ultrasonic cleaning is also an effective way for cleaning. But the influence of Ultrasonic cleaning on LED depends on factors such as ultrasonic power. Generally, the ultrasonic power should not be higher than 300W. Before cleaning, a pre-test should be done to confirm whether any damage to LEDs will occur.

- * **注意:** 此一般指导原则并不适用于所有 PCB 设计和焊接设备的配置。具体工艺受到诸多因素的影响，请根据特定的PCB设计和焊接设备来确定焊接方案。
- * **Note:** This general guideline may not apply to all PCB designs and configurations of all soldering equipment. The technics in practise is influenced by many factors, it should be specialized base on the PCB designs and configurations of the soldering equipment..

使用注意事项 (1)

Precautions (1)

1. 贮存:

Storage

- 本产品使用密封防潮抗静电袋包装，并附有干燥剂，未开封的产品有一年的保存时间。

Moisture proof and anti-electrostatic package with moisture absorbent material is used, to keep moisture to a minimum.

- 开封前，产品须存放在温度不高于 30℃，湿度不高于 60%RH 的环境中。

Before opening the package, the product should be kept at 30℃ or less and humidity less than 60% RH, and be used within a year.

- 开封后，产品须存放在温度不高于 30℃，湿度不高于 10%RH 的环境中，且应该在 168 小时（7 天）内使用完。建议工作环境为温度不高于 30℃，湿度不高于 60%RH。

After opening the package, the product should be stored at 30℃ or less and humidity less than 10%RH, and be soldered within 168 hours (7 days). It is recommended that the product be operated at the workshop condition of 30℃ or less and humidity less than 60%RH.

- 对于尚未焊接的 LED，如果吸湿剂或包装失效，或者产品没有符合以上有效存储条件，烘焙可以起到一定的性能恢复效果。烘焙条件：(60±5)℃，持续 24 小时。

If the moisture absorbent material has fade away or the LEDs have exceeded the storage time, baking treatment should be performed based on the following condition: (60±5)℃ for 24 hours.

2. 静电:

Static Electricity

静电和电涌会导致产品特性发生改变，例如正向电压降低等，如果情况严重甚至会损毁产品。所以在使用时必须采取有效的防静电措施。

所有相关的设备和机器都应该正确接地，同时必须采取其他防止静电和电涌的措施。

使用防静电手环，防静电垫子，防静电工作服、工作鞋、手套，防静电容器，都是有效的防止静电和电涌的措施。

Static electricity or surge voltage damages the LEDs. Damaged LEDs will show some unusual characteristic such as the forward voltage becomes lower, or the LEDs do not light at the low current. even not light.

All devices, equipment and machinery must be properly grounded. At the same time, it is recommended that wrist bands or anti-electrostatic gloves, anti-electrostatic containers be used when dealing with the LEDs.

使用注意事项 (2)

Precautions (2)

3. 设计建议:

Design Consideration

设计电路时，通过 LED 的电流不能超过规定的最大值，同时，还需使用保护电阻，否则，微小的电压变化将会引起较大的电流变化，可能导致产品损毁。

建议使用以下 (A) 电路，该电路能够很好的调节通过每个 LED 的电流；不推荐使用 (B) 电路，该电路在持续的电压驱动下，LED 的正向电压 (V_F) 发生变化，电流会随之而发生变化，可能使某些 LED 承受高于规定的电流值。

In designing a circuit, the current through each LED must not exceed the absolute maximum rating specified for each LED. In the meanwhile, resistors for protection should be applied, otherwise slight voltage shift will cause big current change, burn out may happen.

It is recommended to use Circuit A which regulates the current flowing through each LED rather than Circuit B. When driving LEDs with a constant voltage in Circuit B, the current through the LEDs may vary due to the variation in Forward Voltage (V_F) of the LEDs. In the worst case, some LED may be subjected to stresses in excess of the Absolute Maximum Rating.

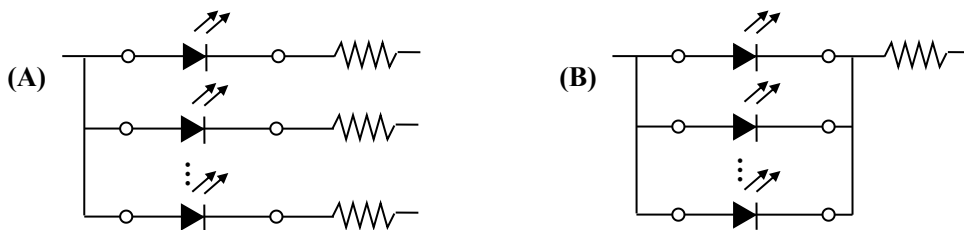

LED 的特性容易因为自身的发热和环境的温度的改变而发生改变。温度的升高会降低 LED 的发光效率、影响发光颜色等，所以在设计时应充分考虑散热的问题。

Thermal Design is paramount importance because heat generation may result in the Characteristics decline, such as brightness decreased, Color changed and so on. Please consider the heat generation of the LEDs when making the system design.

使用注意事项 (3)

Precautions (3)

4. 其他事项:

Others

直接用手拿取产品不但会污染封装树脂表面,也可能由于静电等因素导致产品性能的改变。过度的压力也可能直接影响封装内部的管芯和金线,因此请勿对产品施加过度压力,特别当产品处于高温状态下,例如在回流焊接过程中。

When handling the product, touching the encapsulant with bare hands will not only contaminate its surface, but also affect on its optical characteristics. Excessive force to the encapsulant might result in catastrophic failure of the LEDs due to die breakage or wire deformation. For this reason, please do not put excessive stress on LEDs, especially when the LEDs are heated such as during Reflow Soldering.

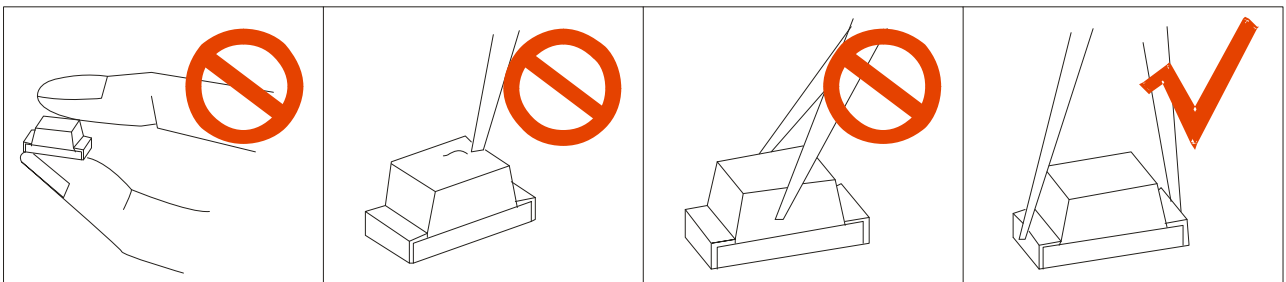

LED 的环氧树脂封装部分相当脆弱,请勿用坚硬、尖锐的物体刮、擦封装树脂部分。在用镊子夹取的时候也应当小心注意。

The epoxy resin of encapsulant is fragile, so please avoid scratch or friction over the epoxy resin surface. While handling the product with tweezers, do not hold by the epoxy resin, be careful.

5. 眼睛保护忠告:

Safety Advice For Human Eyes

LED 发光时,请勿直视发光光源,特别是对于一些光强较高的 LED,强光可能伤害你的眼睛。

Viewing direct to the light emitting center of the LEDs, especially those of great Luminous Intensity, will cause great hazard to human eyes. Please be careful.