

# SR220 THRU SR2200

## 2.0A Axial Leaded Schottky Barrier Rectifiers-20V-200V

### Features

- Metal silicon junction ,majority carrier conduction
- Guard ring for overvoltage protection
- Low power loss ,high efficiency
- High current capability ,Low forward voltage drop
- High surge capability
- For use in low voltage ,high frequency inverters, free wheeling ,and polarity protection applications
- High temperature soldering guaranteed:260°C/10 seconds at terminals
- Lead-free parts meet environmental standards of MIL-STD-19500 /228

### Mechanical data

- Epoxy : UL94-V0 rated flame retardant
- Case : Molded plastic, DO-15
- Lead : Axial leads, solderable per MIL-STD-202, Method 208 guaranteed
- Polarity: Color band denotes cathode end
- Mounting Position : Any

### Package outline

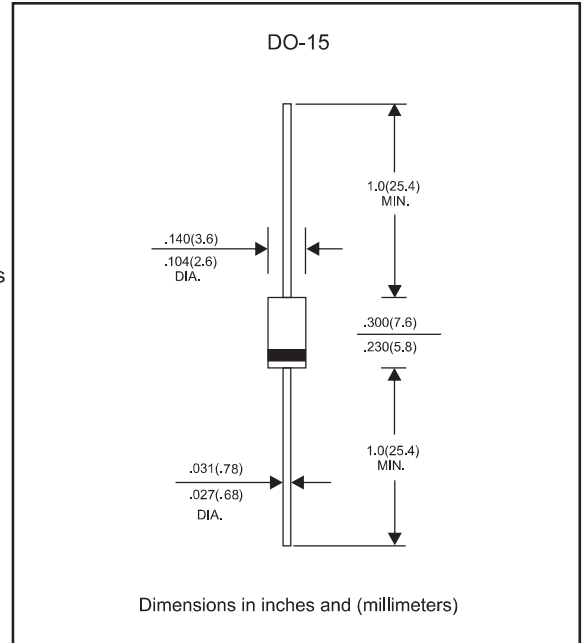

### Maximum ratings and Electrical Characteristics (AT T<sub>A</sub>=25°C unless otherwise noted)

PARAMETER	CONDITIONS	Symbol	MIN.	TYP.	MAX.	UNIT
Forward rectified current	See Fig.1	I <sub>O</sub>			2.0	A
Forward surge current	8.3ms single half sine-wave superimposed on rate load (JEDEC methode)	I <sub>FSM</sub>			50	A
Reverse current	V <sub>R</sub> = V <sub>RRM</sub> T <sub>J</sub> = 25°C	I <sub>R</sub>			0.5	mA
	V <sub>R</sub> = V <sub>RRM</sub> T <sub>J</sub> = 100°C				10	
Thermal resistance	Junction to ambient Note 1	R <sub>θJA</sub>		35		°C/W
Diode junction capacitance	f=1MHz and applied 4V DC reverse voltage	C <sub>J</sub>		170		pF
Storage temperature		T <sub>STG</sub>	-65		+175	°C

Note 1: Thermal resistance from junction to lead, and/or to ambient P. C. B. mounted with 0.375" (9.5mm) lead length with 1.5 X1.5"(38X38mm)copper pads

SYMBOLS	V <sub>RRM</sub> <sup>*1</sup> (V)	V <sub>RMS</sub> <sup>*2</sup> (V)	V <sub>R</sub> <sup>*3</sup> (V)	V <sub>F</sub> <sup>*4</sup> (V)	Operating temperature T <sub>J</sub> , (°C)
SR220	20	14	20	0.55	-55 to +125
SR230	30	21	30		
SR240	40	28	40		
SR250	50	35	50	0.70	-55 to +150
SR260	60	42	60		
SR280	80	56	80	0.85	
SR2100	100	70	100		
SR2150	150	105	150	0.90	
SR2200	200	140	200		

\*1 Repetitive peak reverse voltage

\*2 RMS voltage

\*3 Continuous reverse voltage

\*4 Maximum forward voltage@I<sub>F</sub>=2.0A

## Rating and characteristic curves (SR220 THRU SR2200)

FIG.1-TYPICAL FORWARD CURRENT DERATING CURVE

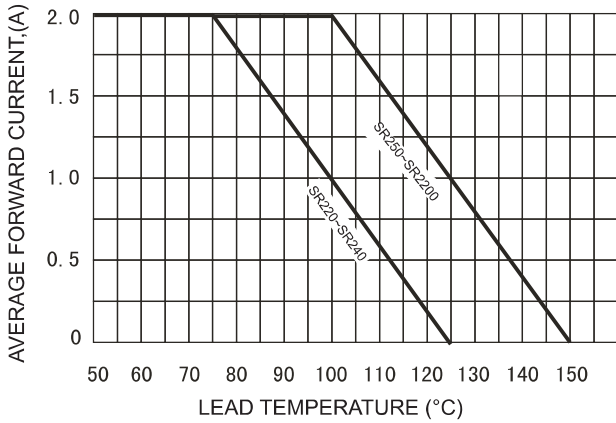

FIG.2-TYPICAL FORWARD CHARACTERISTICS

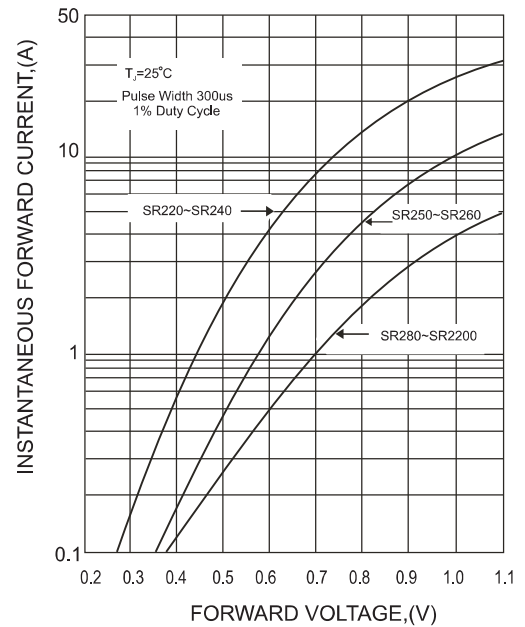

FIG.3-MAXIMUM NON-REPETITIVE FORWARD SURGE CURRENT

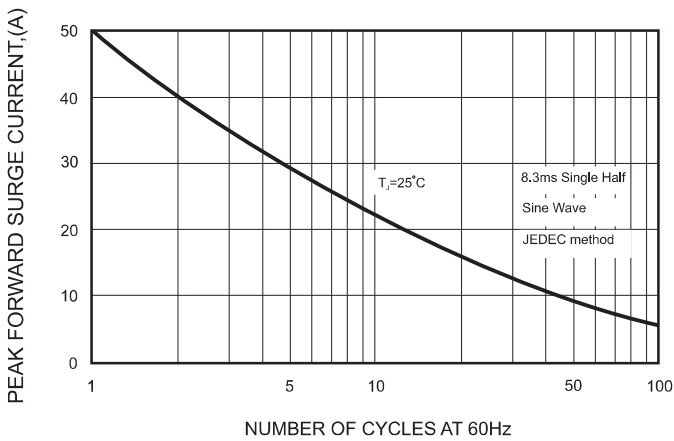

FIG.5 - TYPICAL REVERSE CHARACTERISTICS

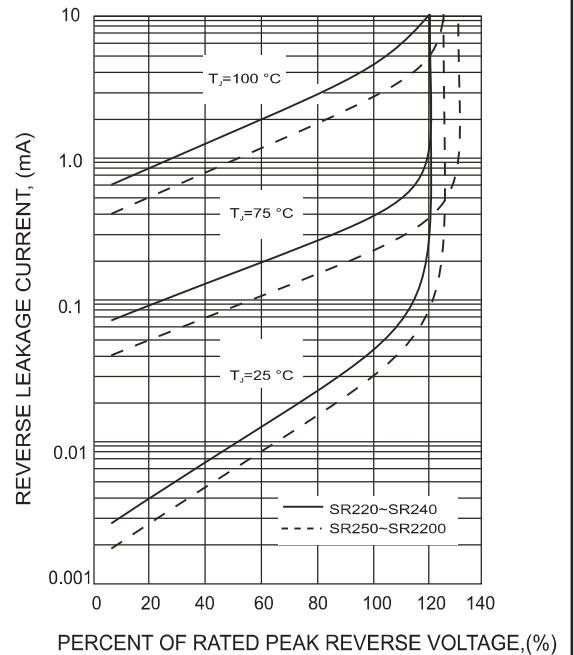
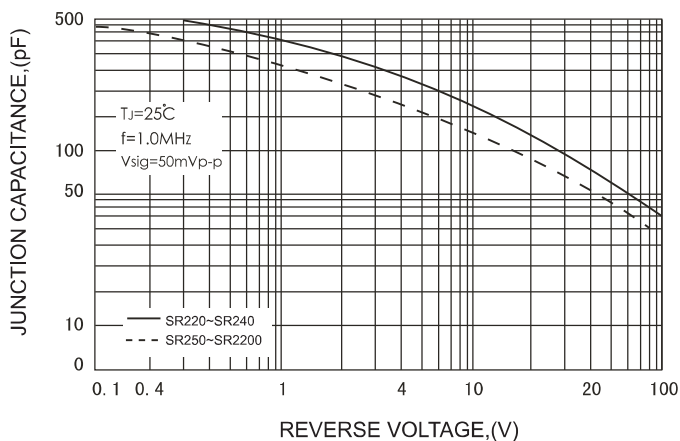



FIG.4-TYPICAL JUNCTION CAPACITANCE



# SR220 THRU SR2200

## Pinning information

Pin	Simplified outline	Symbol
Pin1 cathode Pin2 anode		

## Marking

Type number	Marking code
SR220	SR220
SR230	SR230
SR240	SR240
SR250	SR250
SR260	SR260
SR280	SR280
SR2100	SR2100
SR2150	SR2150
SR2200	SR2200

## Taping & bulk specifications for AXIAL devices

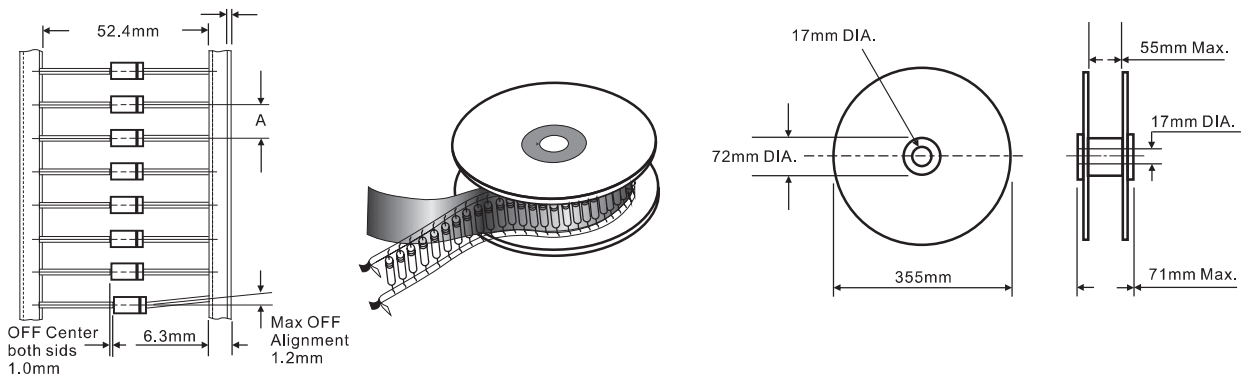

## AMMO PACKING

DEVICE CASE TYPE	Q'TY 1 (PCS / BOX)	INNER BOX SIZE (m/m)	CARTON SIZE (m/m)	Q'TY 2 (PCS / CARTON)	APPROX. CROSS WEIGHT(kg)
DO-15	3,000	260 * 83 * 160	440 * 270 * 340	30,000	14.3