

DESCRIPTION

XD54562 are eight-circuit output-sourcing Darlington transistor arrays. The circuits are made of PNP and NPN transistors. Both the semiconductor integrated circuits perform high-current driving with extremely low input-current supply.

FEATURES

- High breakdown voltage ($BV_{CEO} \geq 50V$)
- High-current driving ($I_o(max) = -500mA$)
- With output clamping diodes
- Driving available with PMOS IC output of 6 ~ 16V or with TTL output
- Wide operating temperature range ($T_a = -20$ to $+75^\circ C$)
- Output current-sourcing type

APPLICATION

Drives of relays, printers, LEDs, fluorescent display tubes and lamps, and interfaces between MOS-bipolar logic systems and relays, solenoids, or small motors

FUNCTION

The XD54562 each have eight circuits, which are made of input inverters and current-sourcing outputs. The outputs are made of PNP transistors and NPN Darlington transistors. The PNP transistor base current is constant. A spike-killer clamping diode is provided between each output and GND. V_s and GND are used commonly among the eight circuits.

The inputs have resistance of $8.5k\Omega$, and voltage of up to 30V is applicable. Output current is 500mA maximum. Supply voltage V_s is 50V maximum.

The XD54562 is enclosed in a molded small flat package, enabling space-saving design.

PIN CONFIGURATION

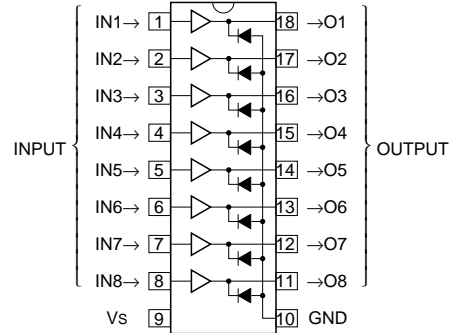

CIRCUIT DIAGRAM

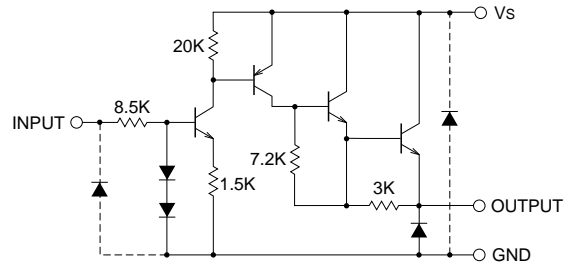

The eight circuits share the V_s and GND.

The diode, indicated with the dotted line, is parasitic, and cannot be used.

Unit : Ω

ABSOLUTE MAXIMUM RATINGS (Unless otherwise noted, Ta = -20 ~ +75°C)

Symbol	Parameter	Conditions	Ratings	Unit
V _{CEO} #	Collector-emitter voltage	Output, L	-0.5 ~ +50	V
V _S	Supply voltage		50	V
V _I	Input voltage		-0.5 ~ +30	V
I _O	Output current	Current per circuit output, H	-500	mA
I _F	Clamping diode forward current		-500	mA
V _R #	Clamping diode reverse voltage		50	V
P _d	Power dissipation	Ta = 25°C, when mounted on board	1.79(P)/1.10(FP)	W
T _{opr}	Operating temperature		-20 ~ +75	°C
T _{stg}	Storage temperature		-55 ~ +125	°C

: Unused I/O pins must be connected to GND.

RECOMMENDED OPERATING CONDITIONS (Unless otherwise noted, Ta = -20 ~ +75°C)

Symbol	Parameter	Limits			Unit	
		min	typ	max		
V _S	Supply voltage	0	—	50	V	
I _O	Output current (Current per 1 circuit when 8 circuits are coming on simultaneously)	Duty Cycle P : no more than 8% FP : no more than 5%	0	—	-350	mA
		Duty Cycle P : no more than 55% FP : no more than 30%	0	—	-100	
V _{IH}	"H" input voltage	2.4	5	30	V	
V _{IL}	"L" input voltage	0	—	0.2	V	

ELECTRICAL CHARACTERISTICS (Unless otherwise noted, Ta = -20 ~ +75°C)

Symbol	Parameter	Test conditions	Limits			Unit
			min	typ*	max	
I _S (leak) #	Supply leak current	V _S = 50V, V _I = 0.2V	—	—	100	μA
V _{CE} (sat)	Collector-emitter saturation voltage	V _S = 10V, V _I = 2.4V, I _O = -350mA	—	1.75	2.4	V
		V _S = 10V, V _I = 2.4V, I _O = -100mA	—	1.50	2.0	
I _I	Input current	V _I = 5V	—	0.48	0.75	mA
		V _I = 25V	—	2.8	4.7	
I _S	Supply current	V _S = 50V, V _I = 5V (all input)	—	5.6	15.0	mA
V _F	Clamping diode forward voltage	I _F = -350mA	—	-1.2	-2.4	V
I _R #	Clamping diode reverse current	V _R = 50V	—	—	100	μA

* : The typical values are those measured under ambient temperature (Ta) of 25°C. There is no guarantee that these values are obtained under any conditions.

: Unused I/O pins must be connected to GND.

SWITCHING CHARACTERISTICS (Unless otherwise noted, Ta = 25°C)

Symbol	Parameter	Test conditions	Limits			Unit
			min	typ	max	
t _{on}	Turn-on time	C _L = 15pF (note 1)	—	110	—	ns
t _{off}	Turn-off time		—	5200	—	ns

NOTE 1 TEST CIRCUIT

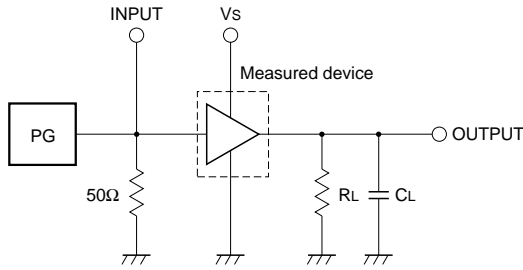

- (1) Pulse generator (PG) characteristics : PRR = 1kHz,
 $t_w = 10\mu s$, $t_r = 6ns$, $t_f = 6ns$, $Z_o = 50\Omega$
 $V_i = 0$ to $2.4V$
- (2) Input-output conditions : $R_L = 30\Omega$, $V_s = 10V$
- (3) Electrostatic capacity C_L includes floating capacitance at connections and input capacitance at probes

TIMING DIAGRAM

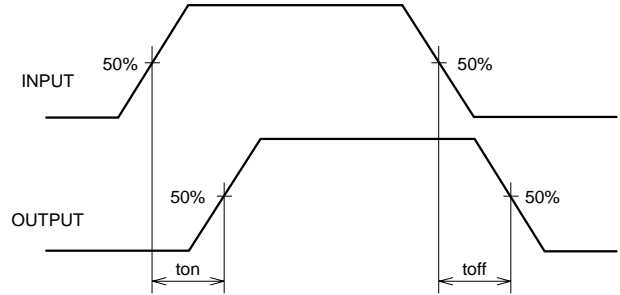

TYPICAL CHARACTERISTICS

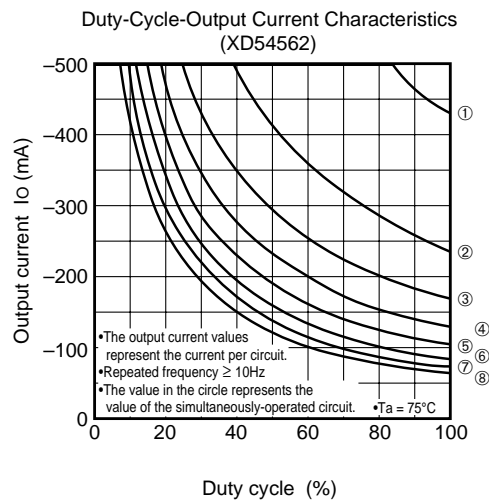
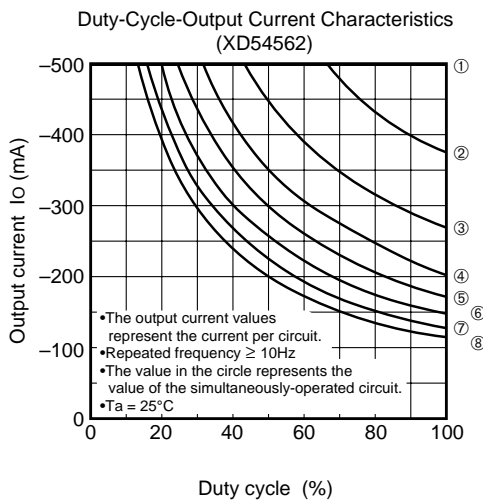
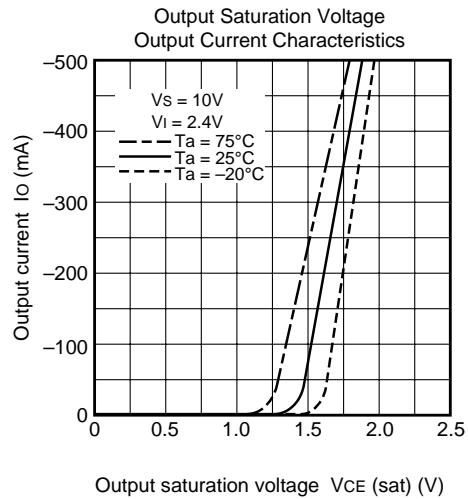
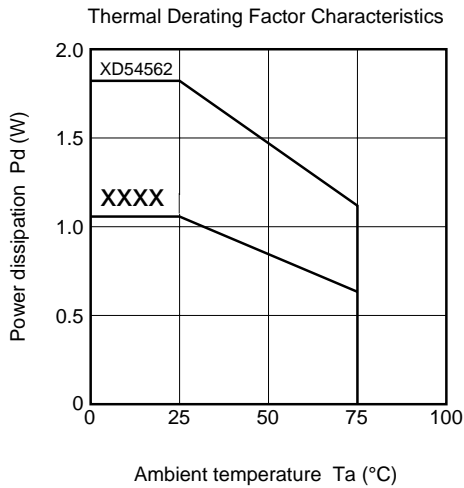

DIP

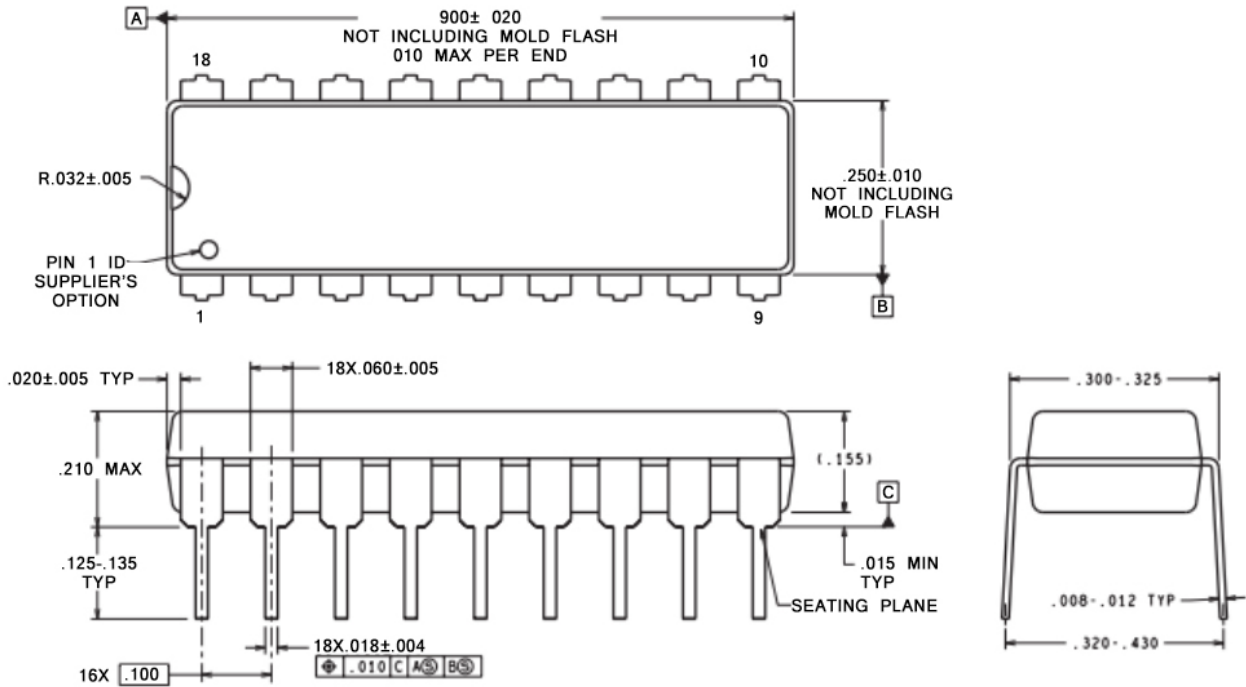

以上信息仅供参考. 如需帮助联系客服人员。谢谢 XINLU DA