

700V N-Channel MOSFET

FEATURES

- Fast switching
- 100% avalanche tested
- Improved dv/dt capability

APPLICATIONS

- Switch Mode Power Supply (SMPS)
- Uninterruptible Power Supply (UPS)
- Power Factor Correction (PFC)

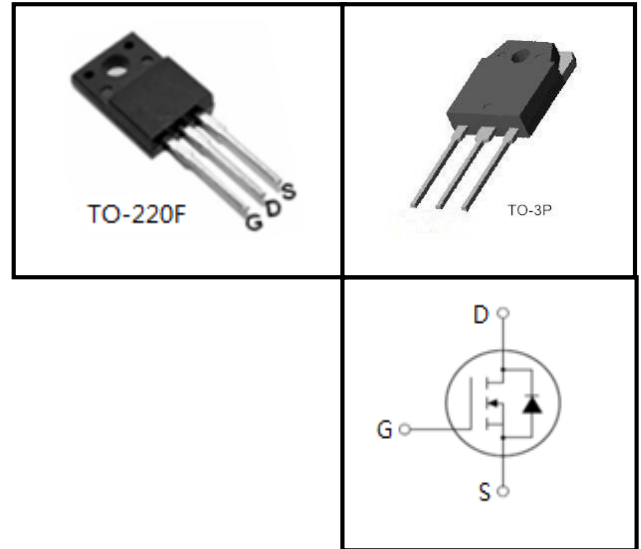

Device Marking and Package Information

Device	Package	Marking
CS18N70F	TO-220F	CS18N70F
CS18N70V	TO-3P	CS18N70V

Absolute Maximum Ratings $T_C = 25^\circ\text{C}$, unless otherwise noted

Parameter	Symbol	Value		Unit
		TO-220F	TO-3P	
Drain-Source Voltage ($V_{GS} = 0\text{V}$)	V_{DSS}	700		V
Continuous Drain Current	I_D	18		A
Pulsed Drain Current (note1)	I_{DM}	72		A
Gate-Source Voltage	V_{GSS}	± 30		V
Single Pulse Avalanche Energy (note2)	E_{AS}	352.8		mJ
Avalanche Current (note1)	I_{AR}	8.4		A
Repetitive Avalanche Energy (note1)	E_{AR}	211.68		mJ
Power Dissipation ($T_C = 25^\circ\text{C}$)	P_D	25	70	W
Operating Junction and Storage Temperature Range	T_J, T_{stg}	-55~+150		$^\circ\text{C}$

Thermal Resistance

Parameter	Symbol	Value		Unit
		TO-220F	TO-3P	
Thermal Resistance, Junction-to-Case	R_{thJC}	5	1.78	K/W
Thermal Resistance, Junction-to-Ambient	R_{thJA}	62.5	60	

Specifications $T_J = 25^\circ\text{C}$, unless otherwise noted						
Parameter	Symbol	Test Conditions	Value			Unit
			Min.	Typ.	Max.	
Static						
Drain-Source Breakdown Voltage	$V_{(BR)DSS}$	$V_{GS} = 0V, I_D = 250\mu\text{A}$	700	--	--	V
Zero Gate Voltage Drain Current	I_{DSS}	$V_{DS} = 700V, V_{GS} = 0V, T_J = 25^\circ\text{C}$	--	--	1	μA
Gate-Source Leakage	I_{GSS}	$V_{GS} = \pm 30V$	--	--	± 100	nA
Gate-Source Threshold Voltage	$V_{GS(th)}$	$V_{DS} = V_{GS}, I_D = 250\mu\text{A}$	3.0	--	4.0	V
Drain-Source On-Resistance (Note3)	$R_{DS(on)}$	$V_{GS} = 10V, I_D = 9A$	--	0.45	0.55	Ω
Dynamic						
Input Capacitance	C_{iss}	$V_{GS} = 0V,$ $V_{DS} = 25V,$ $f = 1.0\text{MHz}$	--	2589	--	pF
Output Capacitance	C_{oss}		--	233.5	--	
Reverse Transfer Capacitance	C_{rss}		--	28.6	--	
Total Gate Charge	Q_g	$V_{DD} = 560V, I_D = 18A,$ $V_{GS} = 10V$	--	73.5	--	nC
Gate-Source Charge	Q_{gs}		--	10.2	--	
Gate-Drain Charge	Q_{gd}		--	35	--	
Turn-on Delay Time	$t_{d(on)}$	$V_{DD} = 350V, I_D = 18A,$ $R_G = 25\Omega$	--	54	--	ns
Turn-on Rise Time	t_r		--	25.7	--	
Turn-off Delay Time	$t_{d(off)}$		--	334	--	
Turn-off Fall Time	t_f		--	57.7	--	
Drain-Source Body Diode Characteristics						
Continuous Body Diode Current	I_S	$T_C = 25^\circ\text{C}$	--	--	18	A
Pulsed Diode Forward Current	I_{SM}		--	--	72	
Body Diode Voltage	V_{SD}	$T_J = 25^\circ\text{C}, I_{SD} = 9A, V_{GS} = 0V$	--	--	1.4	V
Reverse Recovery Time	t_{rr}	$V_{GS} = 0V, I_S = 18A,$ $di_F/dt = 100A/\mu\text{s}$	--	770	--	ns
Reverse Recovery Charge	Q_{rr}		--	5.4	--	μC

Notes

1. Repetitive Rating: Pulse width limited by maximum junction temperature
2. $L = 10.0\text{mH}, V_{DD} = 50V, R_G = 25\Omega$, Starting $T_J = 25^\circ\text{C}$
3. Pulse Test: Pulse width $\leq 300\mu\text{s}$, Duty Cycle $\leq 1\%$

Typical Characteristics $T_J = 25^\circ\text{C}$, unless otherwise noted

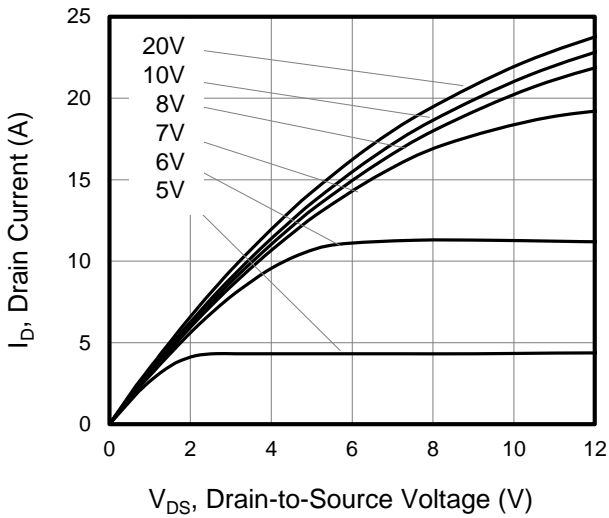
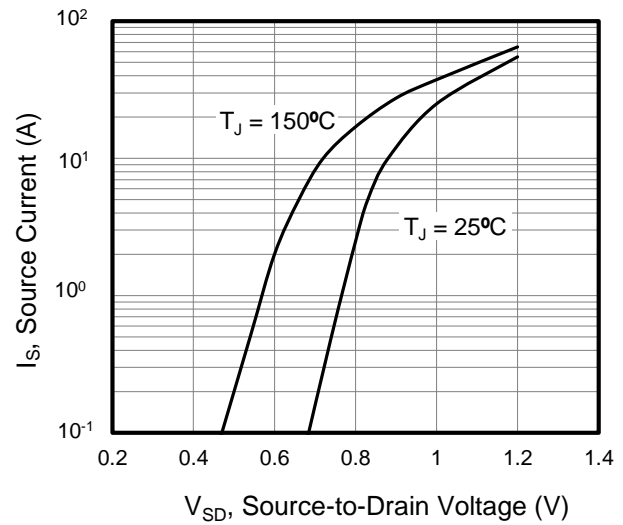
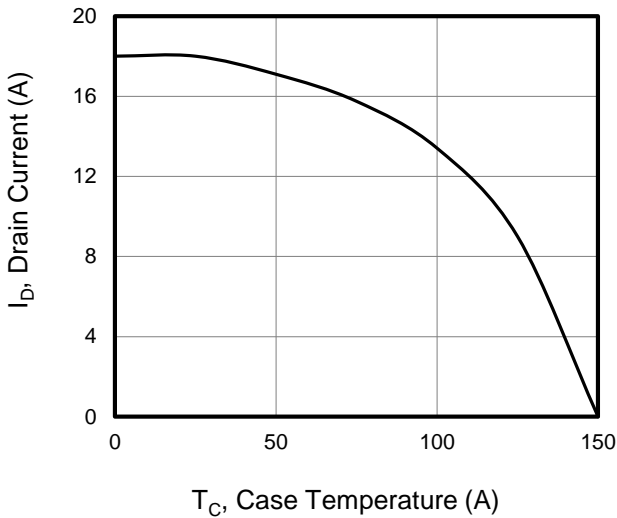
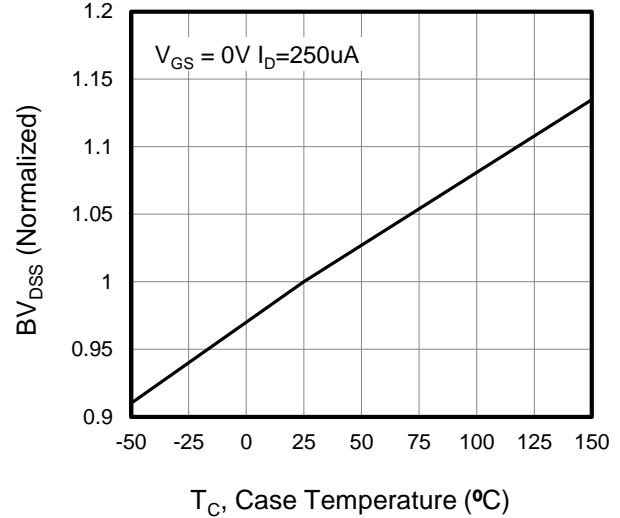
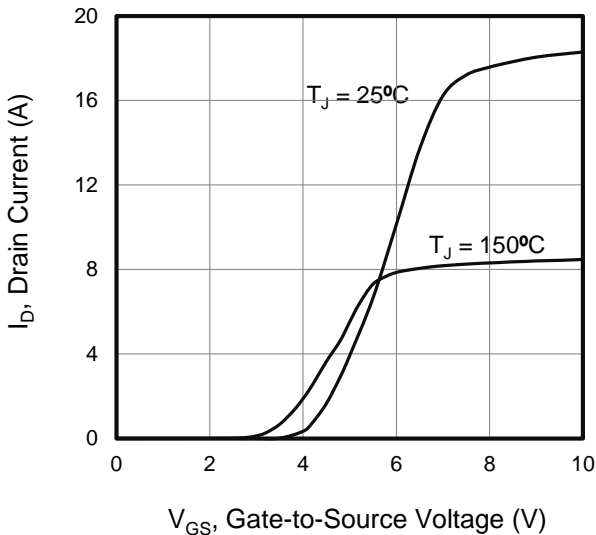
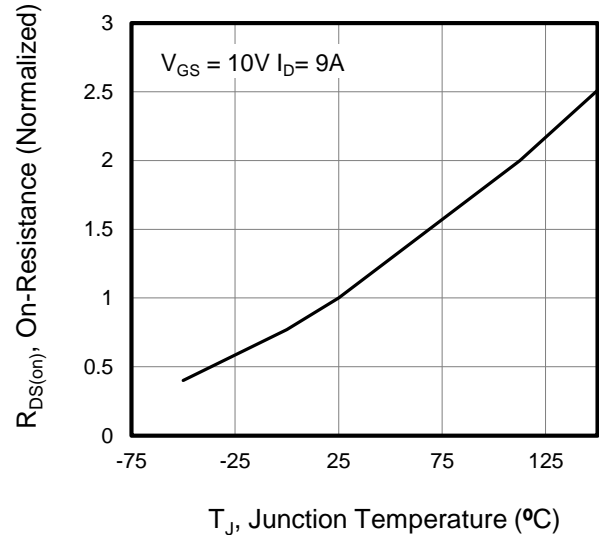
Figure 1. Output Characteristics ($T_J = 25^\circ\text{C}$)

Figure 2. Body Diode Forward Voltage

Figure 3. Drain Current vs. Temperature

Figure 4. BV_{DSS} Variation vs. Temperature

Figure 5. Transfer Characteristics

Figure 6. On-Resistance vs. Temperature

Typical Characteristics $T_J = 25^\circ\text{C}$, unless otherwise noted

Figure 7. Capacitance

Figure 8. Gate Charge

Figure 9. Transient Thermal Impedance TO-220F

Figure 10. Transient Thermal Impedance TO-3P

Figure A: Gate Charge Test Circuit and Waveform

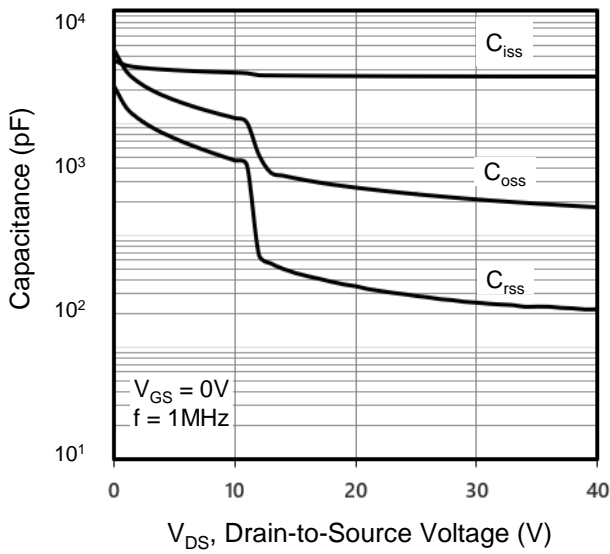
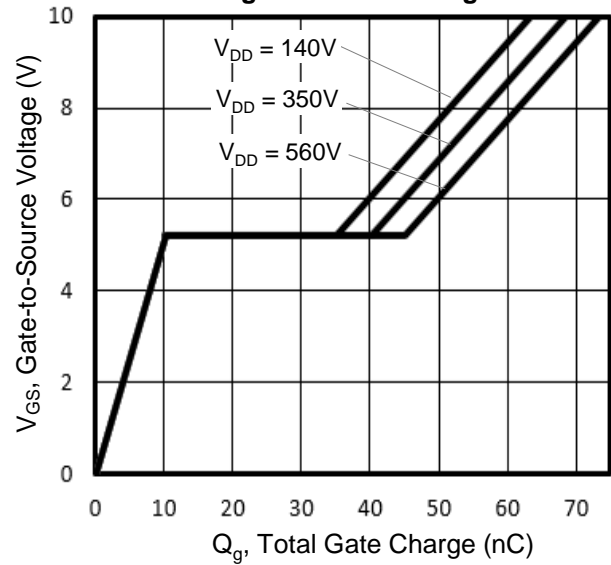
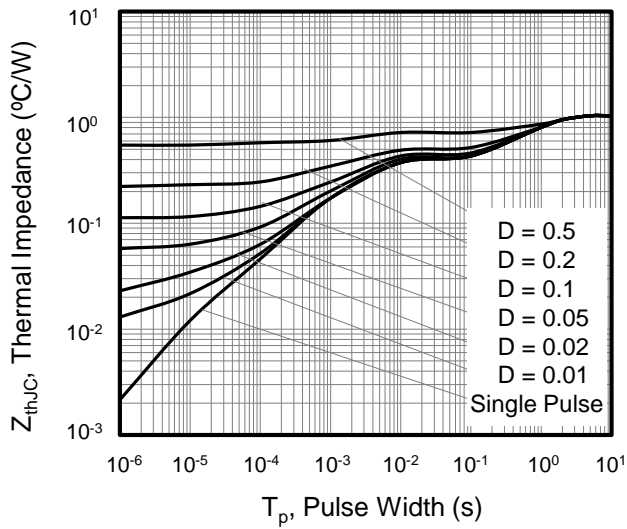
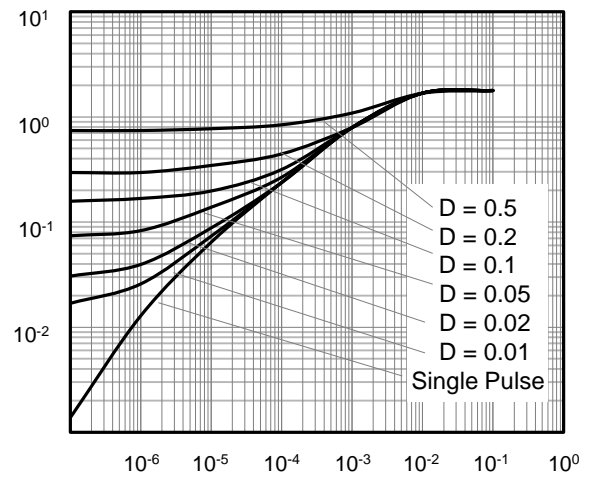
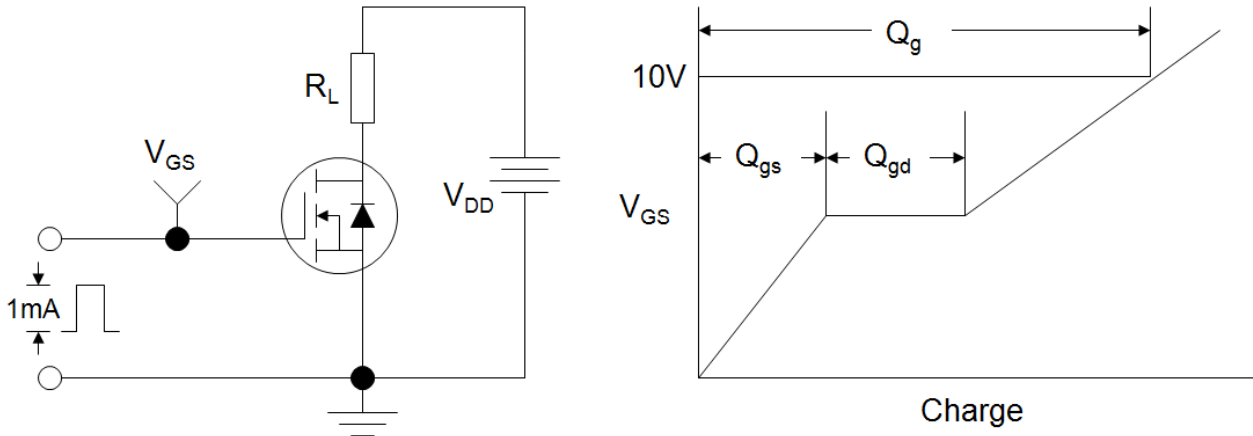
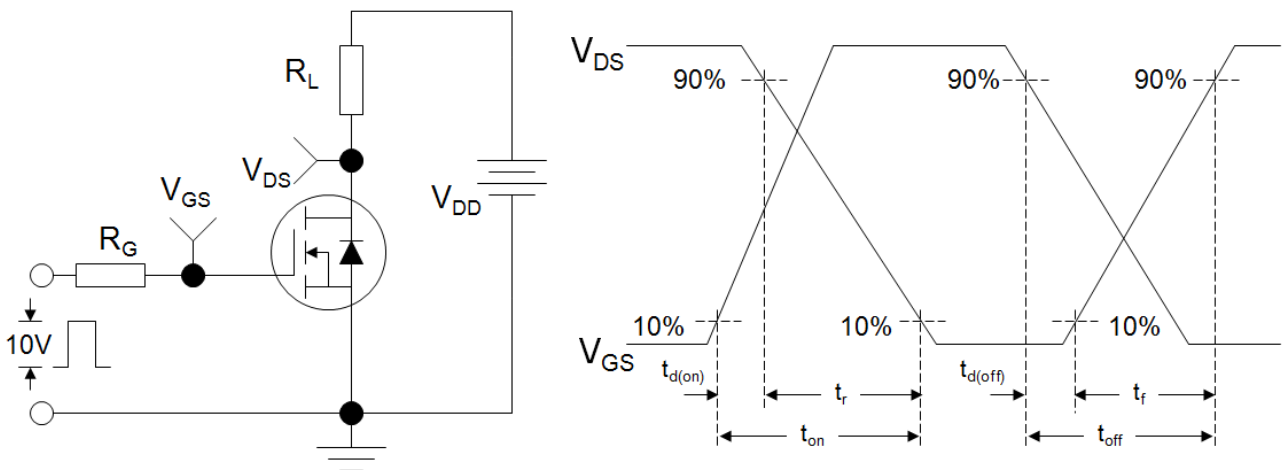
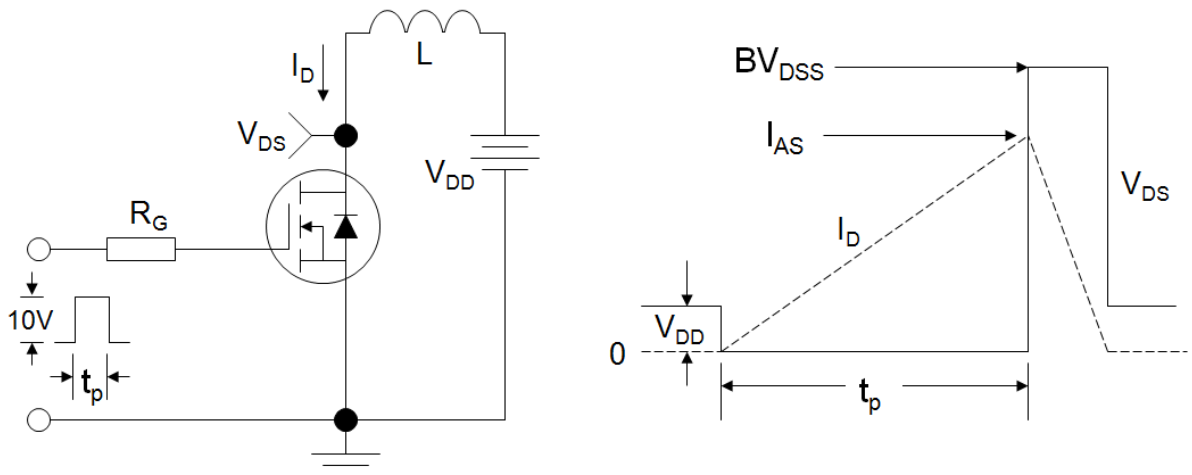
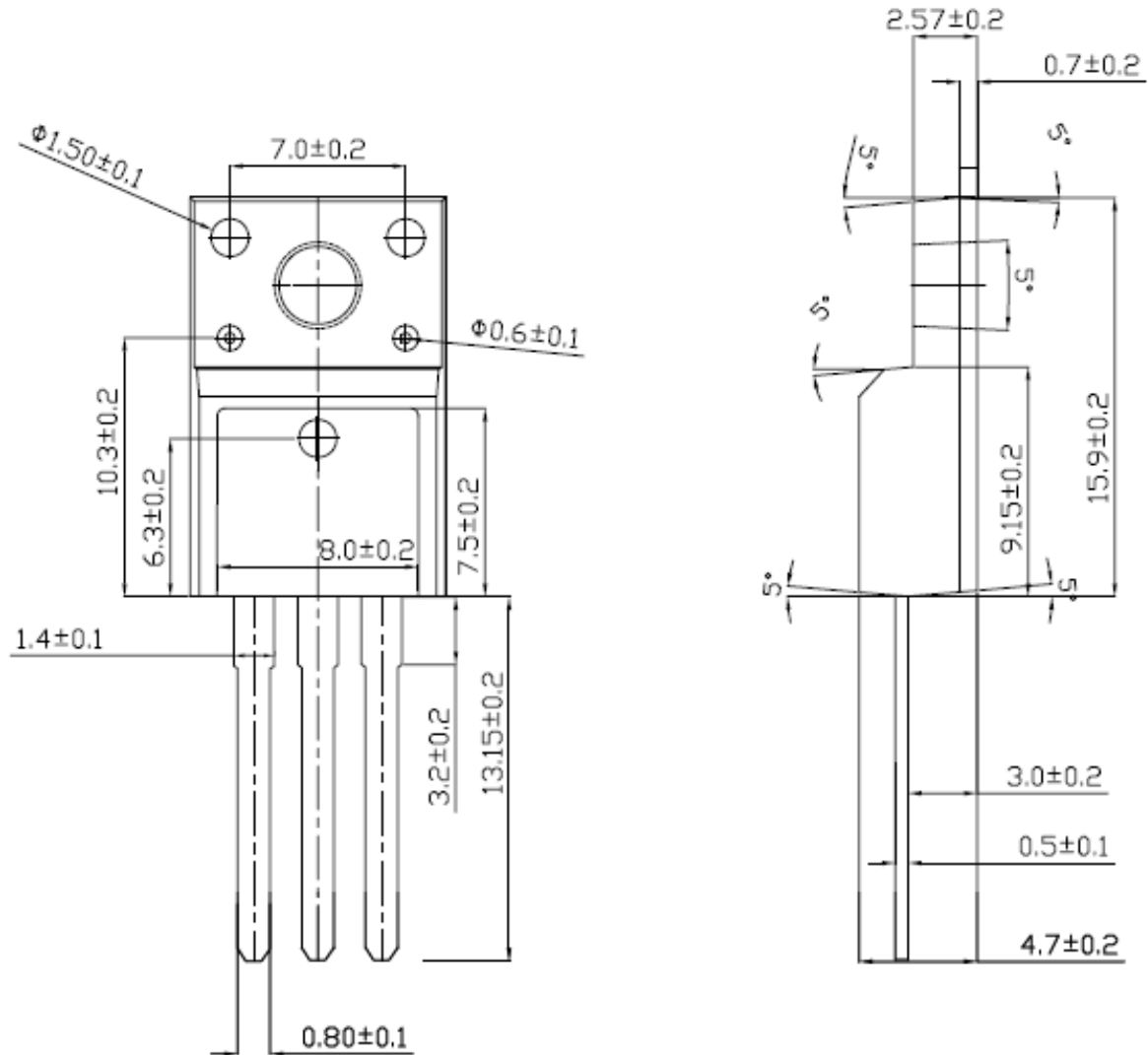
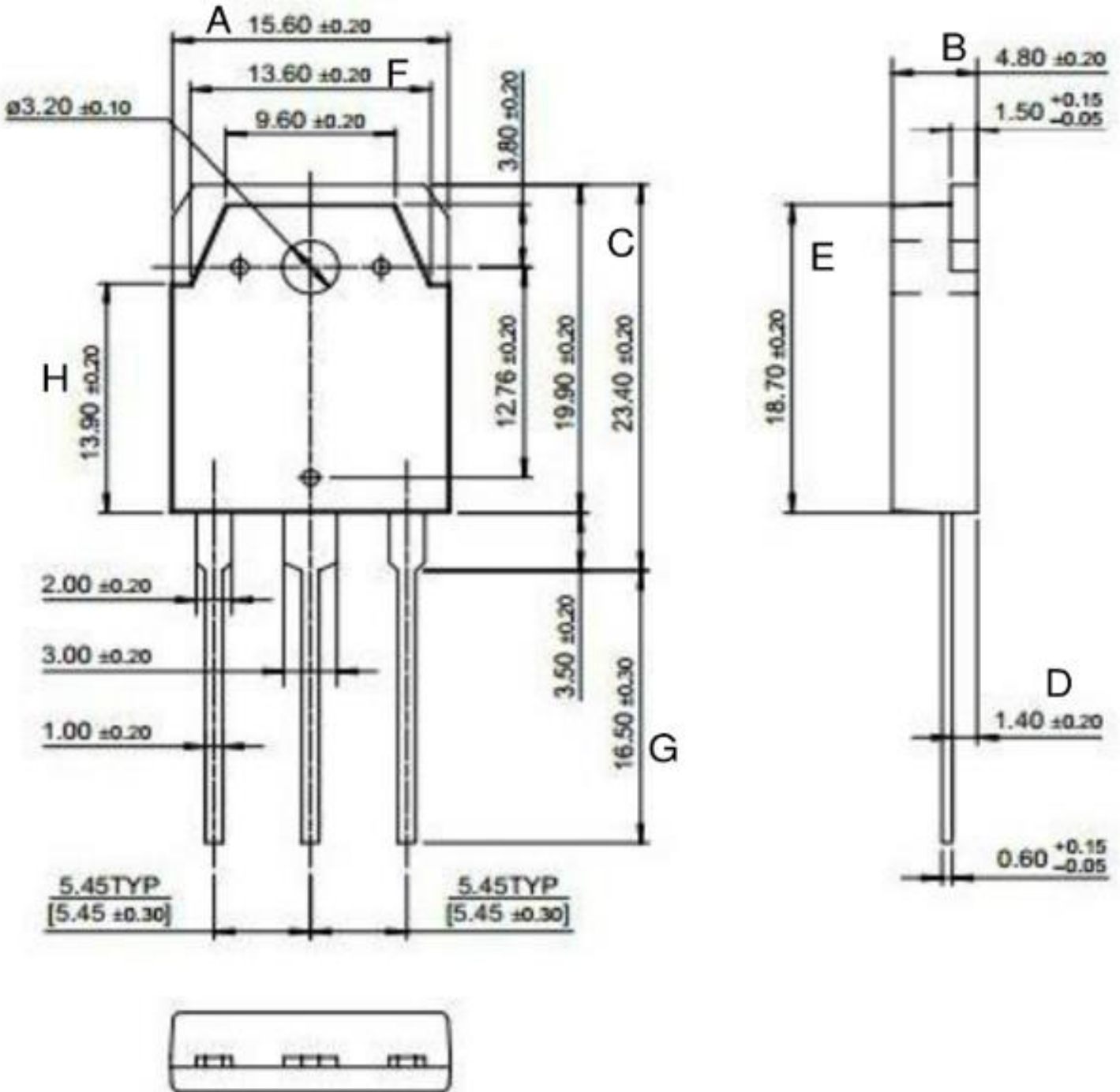
Figure B: Resistive Switching Test Circuit and Waveform

Figure C: Unclamped Inductive Switching Test Circuit and Waveform

TO-220F

TO-3P

Disclaimer

All product specifications and data are subject to change without notice.

For documents and material available from this datasheet, Suzhou Convert does not warrant or assume any legal liability or responsibility for the accuracy, completeness of any product or technology disclosed hereunder.

No license, express or implied, by estoppels or otherwise, to any intellectual property rights is granted by this document or by any conduct of Suzhou Convert.

The products shown herein are not designed for use in medical, life-saving, or life-sustaining applications unless. Customers using or selling Suzhou Convert products not expressly indicated for use in such applications do so entirely at their own risk and agree to fully indemnify Suzhou Convert for any damages arising or resulting from such use or sale.

Suzhou Convert disclaims any and all liability arising out of the use or application of any product described herein or of any information provided herein to the maximum extent permitted by law. The product specifications do not expand or otherwise modify Suzhou Convert's terms and conditions of purchase, including but not limited to the warranty expressed therein, which apply to these products.

Suzhou Convert SemiConductor CO., Ltd. strives to supply high-quality high-reliability products. However, any and all semiconductor products fail with some probability. It is possible that these probabilistic failures could give rise to accidents or events that could endanger human lives that could give rise to smoke or fire, or that could cause damage to other property. When designing equipment, adopt safety measures so that these kinds of accidents or events cannot occur. Such measures include but are not limited to protective circuits and error prevention circuits for safe design, redundant design, and structural design.

In the event that any or all Suzhou Convert products(including technical data, services) described or contained herein are controlled under any of applicable local export control laws and regulations, such products must not be exported without obtaining the export license from the authorities concerned in accordance with the above law.

Information (including circuit diagrams and circuit parameters) herein is for example only; it is not guaranteed for volume production. Suzhou Convert believes information herein is accurate and reliable, but no guarantees are made or implied regarding its use or any infringements of intellectual property rights or other rights of third parties.