

GMA	信阳市谷麦光电子科技有限公司 XINYANG CITY GMA OPTOELECTRONIC TECHNOLOGY LIMITED	规格书	
	LC-S01-WB-B22H 产品规格书	文件编号	GMA-XY-W-D-287B0
此文件为信阳市谷麦光电子科技有限公司的机密文件，未经许可，不能复制或发给外间机构		制定部门	开发科

3804 (白光) 产 品

规 格 书

型号 MODEL No.: LC-S01-WB-B22H
 尺寸 SIZE: L,3.8mm W,0.4mm H,0.9mm
 适用条件: 顺向电流IF=20mA

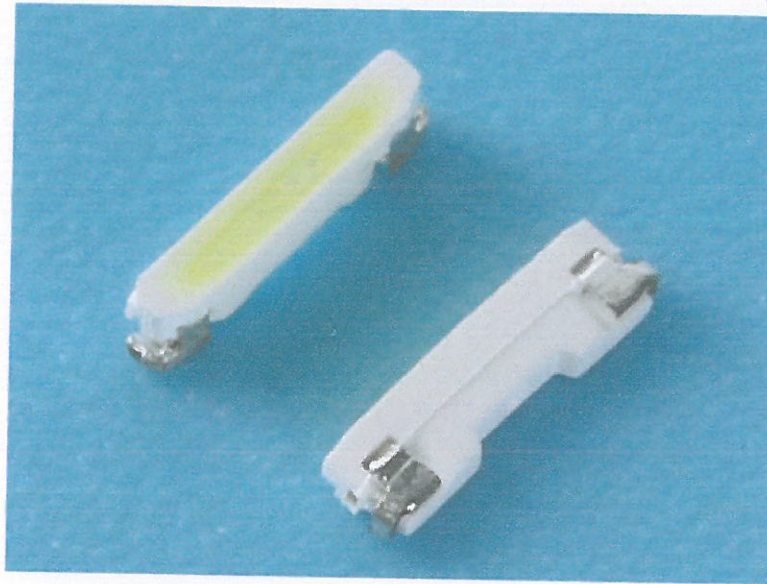

信阳市谷麦光电子科技有限公司
 XINYANG CITY GMA OPTOELECTRONIC TECHNOLOGY LIMITED

工厂地址: 广东省东莞市石排镇埔心工业区
 信阳市浉河区金牛产业集聚区富强路1号

Tel: 0769-81701999 Fax: 0769-81701699

核准:

张嘉光

审核:

张嘉光

制定: 周金玲

GMA	信阳市谷麦光电子科技有限公司 XINYANG CITY GMA OPTOELECTRONIC TECHNOLOGY LIMITED	规格书	
	LC-S01-WB-B22H 产品规格书	文件编号	GMA-XY-W-D-287B0
此文件为信阳市谷麦光电子科技有限公司的机密文件，未经许可，不能复制或发给外间机构		制定部门	开发科

目录 List

- 1.特性 Features
- 2.成品外观尺寸 Packing Dimensions
- 3.应用范围 Applications
- 4.光电特性参数 Electrical and Optical Characteristics
- 5.最大绝对标称值 Absolute Maximum Ratings
- 6.光电特性曲线 Optoelectronics Characteristics Typical Curves
- 7.编带规格 Tapping Specifications
- 8.包装方式 Way of Packing
- 9.包装规格及标签说明 Packing Specifications and Label
- 10.BIN级范围 Bin Code
- 11.信赖度测试及条件 Reliability Test
- 12.使用注意事项 Points for Attention



LC-S01-WB-B22H 产品规格书

文件编号

GMA-XY-W-D-287B0

制定部门

开发科

此文件为信阳市谷麦光电科技有限公司的机密文件，未经许可，不能复制或发给外间机构

● 特性 Features:

1. Emitted Color : White.
发光颜色: 白色
2. Suitable for all SMT assembly methods.
适合所有SMT组装方法
3. Compatible with infrared and vapor phase reflow solder process.
适合回流焊及红外焊
4. Compatible with automatic chip mounter.
适合自动贴片设备
5. Meet ROHS standard.
符合ROHS标准

● 成品外观尺寸 Packing Dimensions:

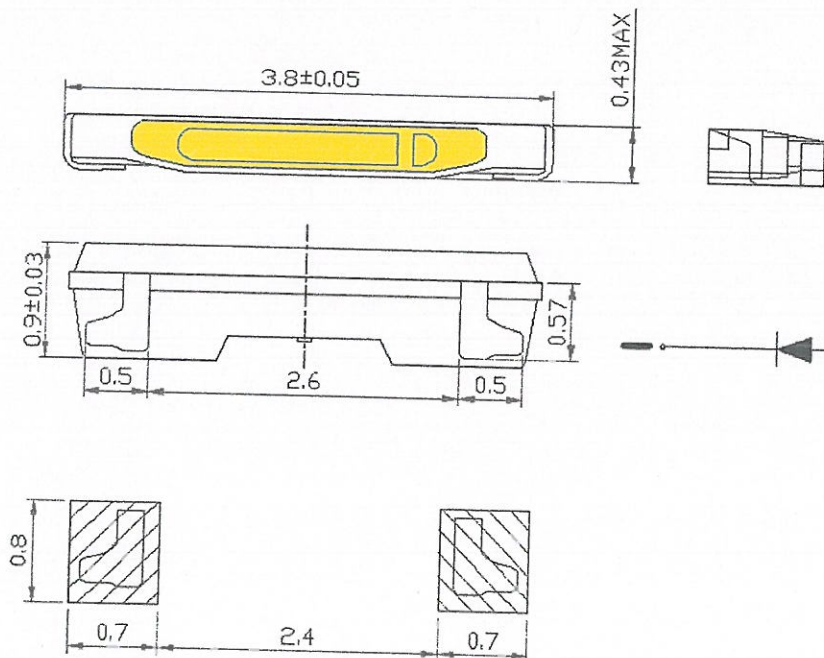

备注 NOTES:

1. All dimensions are in millimeters.
单位: 毫米
2. Tolerance is ± 0.10 mm unless otherwise specified.
无明确标注下, 公差均为 ± 0.05 mm

LC-S01-WB-B22H 产品规格书

文件编号 GMA-XY-W-D-287B0

制定部门 开发科

此文件为信阳市谷麦光电子科技有限公司的机密文件, 未经许可, 不能复制或发给外间机构

● 应用范围 Applications:

1. LCD back light for mobile phone,iPad,iPhone.

LCD背光手机、ipad、iphone等

2. LCD back light for digital product(MP3/MP4).

液晶背光源的数码产品(如MP3, MP4)

● 光电特性参数(环境温度=25℃) Electrical and optical characteristics(Ta=25℃)

参数Parameter	符号Symbol	条件Condition	最小值Min.	标称值Typ.	最大值Max.	单位Unit
电压Forward Voltage	VF	$I_F=20mA$	2.8		3.2	V
亮度Luminous Intensity	lv	$I_F=20mA$	3000		3600	mcd
色度坐标 Chromaticity Coordinates	x	$I_F=20mA$	0.2612		0.3072	-
	y	$I_F=20mA$	0.2345		0.3105	-
反向电流Reverse Current	IR	$V_r=5V$	0		1	uA
发光角度Viewing Angle	$2\theta_{1/2}$		-	120		Deg

● 最大绝对标称值(环境温度=25℃) Absolute Maximum Ratings(Ta=25℃)



参数Parameter	符号Symbol	标称值Rating	单位Unit
消耗功率Power Dissipation	Pd	100	mW
顺向电流Forward Current	I_F	30	mA
顺向峰值电流 *1 Peak Forward Current *1	I_{FP}	60	mA
使用温度Operating Temperature	Topr	-40℃~85℃	℃
储藏温度Storage Temperature	Tstg	-40℃~100℃	℃
焊接温度Soldering Temperature	Tsol	Reflow Soldering:260℃ for 10 secs Hand Soldering:350℃ for 3 secs	

I_{FP} 条件: 脉宽 $\leq 0.1msec$, 周期 $\leq 1/10$, Condition for I_{FP} is pulse of 1/10 duty and 30 msec width.

LC-S01-WB-B22H 产品规格书

文件编号 GMA-XY-W-D-287B0
制定部门 开发科

此文件为信阳市谷麦光电子科技有限公司的机密文件，未经许可，不能复制或发给外间机构

● 光电特性曲线 Typical Electro-Optical Characteristics Curves

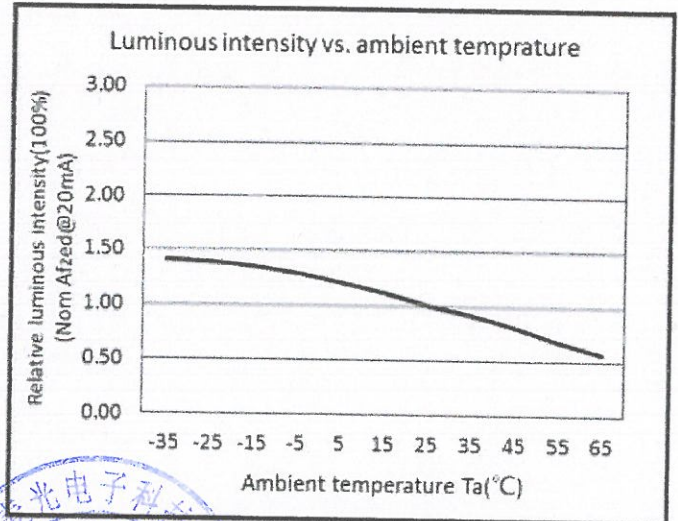
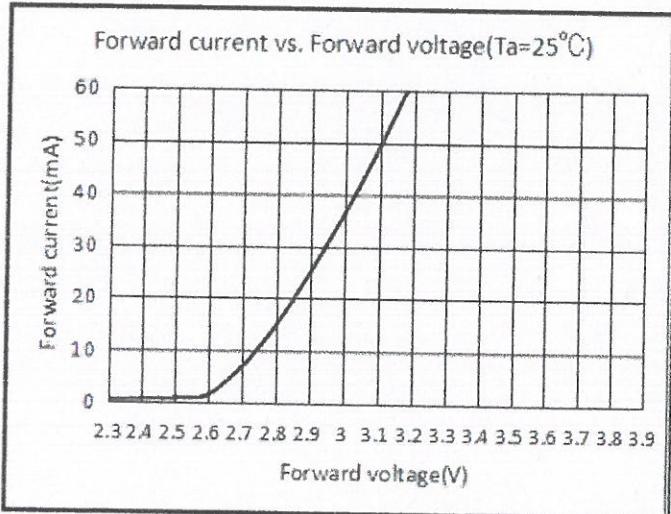
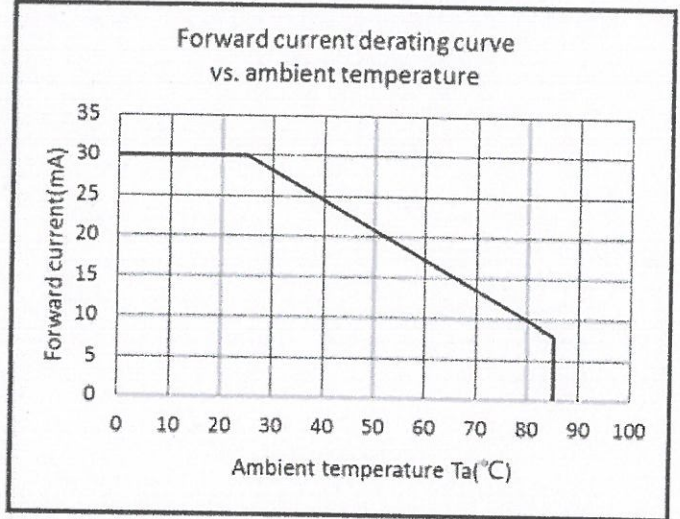
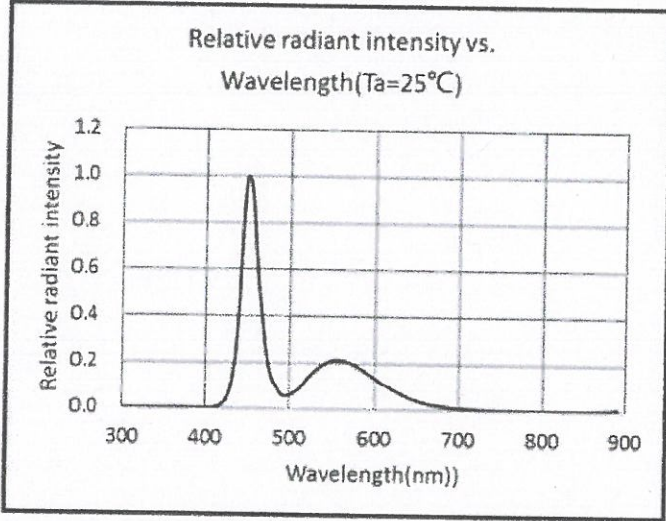

注：IV曲线取样为2.8V的中心电压。取样条件 (IF:20mA)

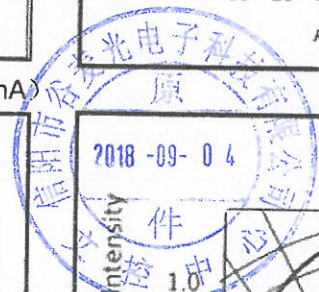
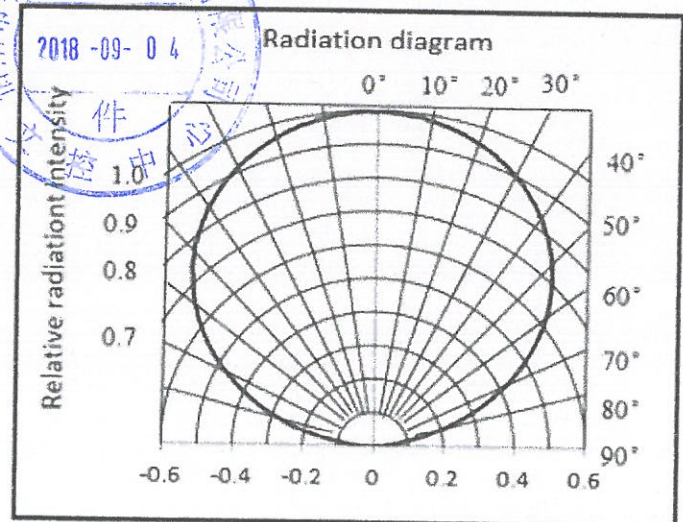
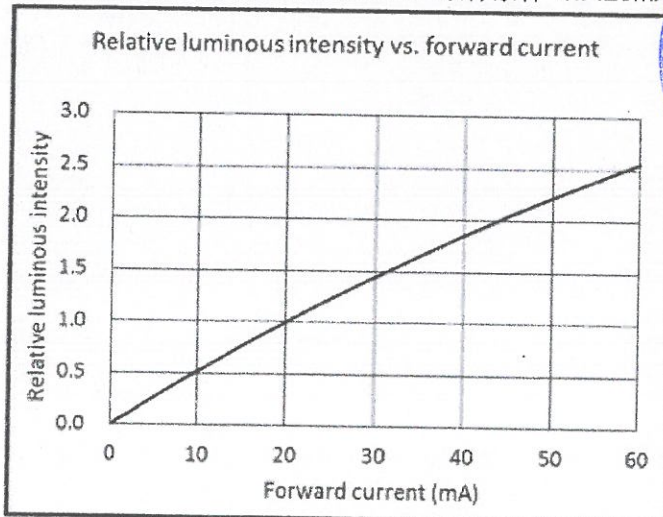

LC-S01-WB-B22H 产品规格书

文件编号 GMA-XY-W-D-287B0

制定部门 开发科

此文件为信阳市谷麦光电子科技有限公司的机密文件，未经许可，不能复制或发给外间机构

● 编带规格 (单位: mm) Tapping specifications (Units: mm)

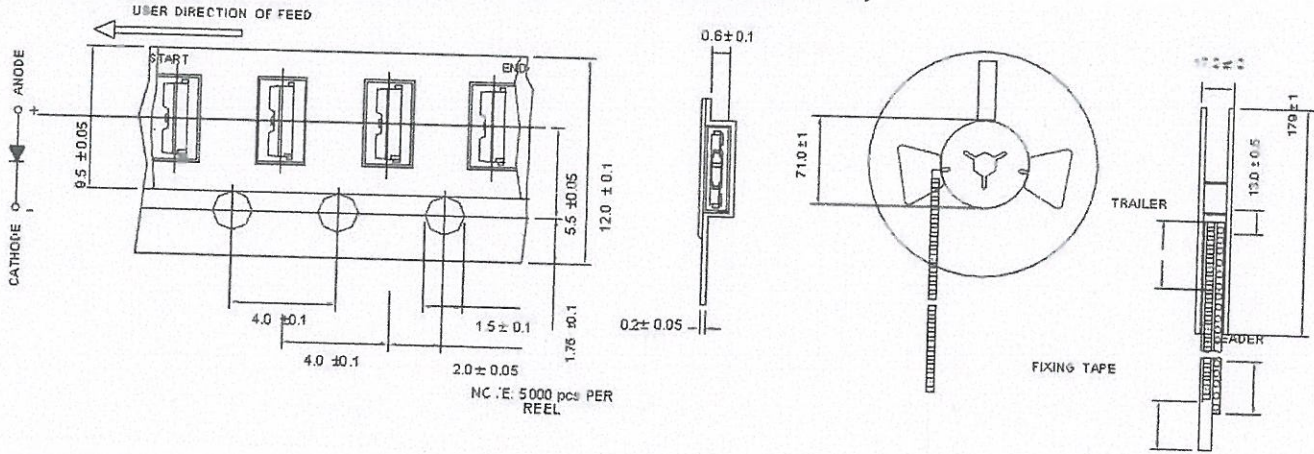

● 包装方式:(单位:mm) Package Method:(unit:mm)

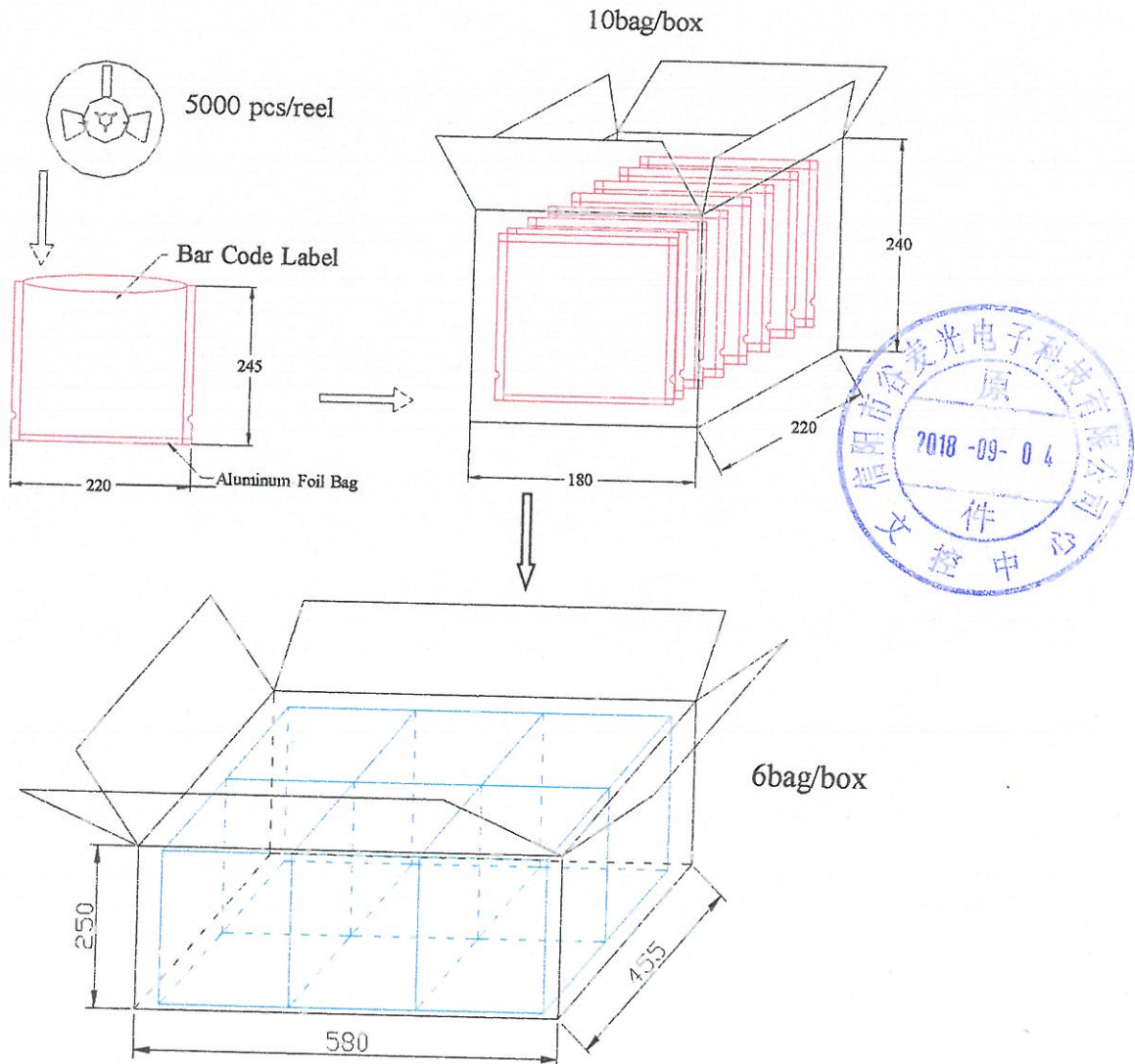

LC-S01-WB-B22H 产品规格书

文件编号 GMA-XY-W-D-287B0

制定部门 开发科

此文件为信阳市谷麦光电子科技有限公司的机密文件，未经许可，不能复制或发给外间机构

色度坐标图 Color map(I_f=20mA)

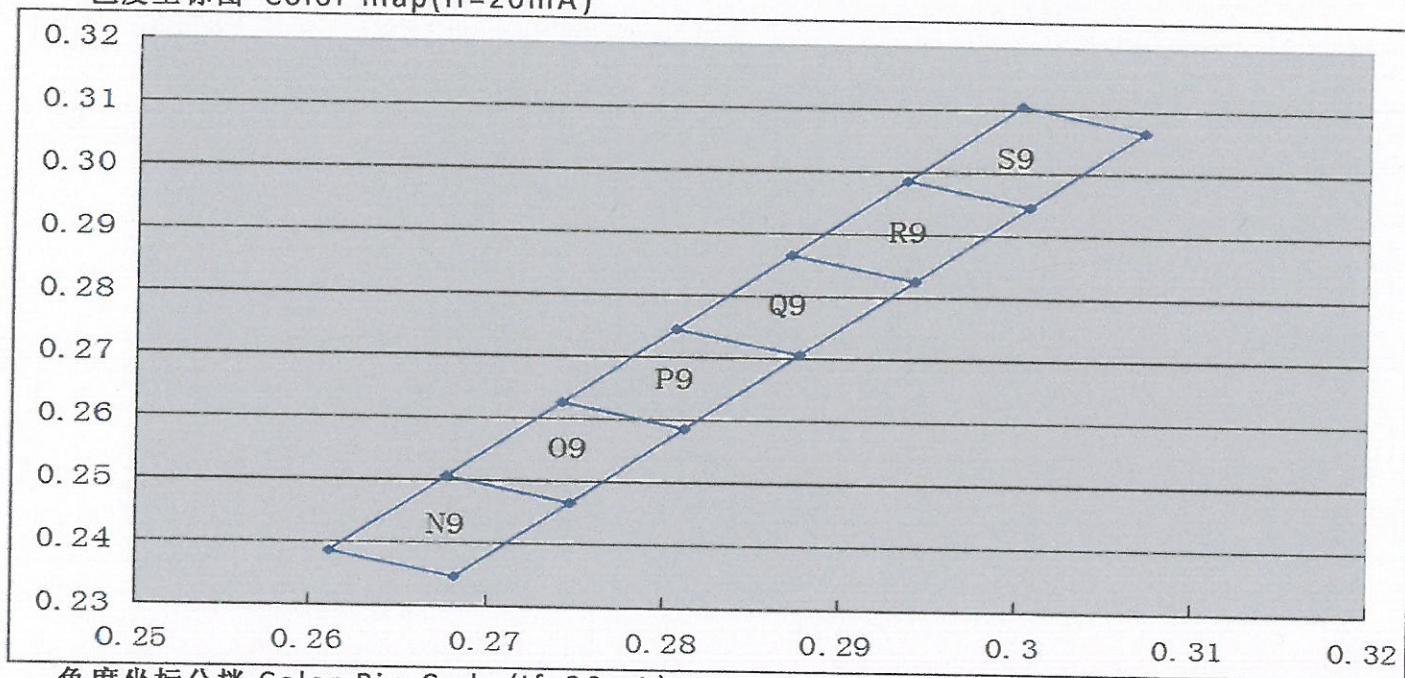

色度坐标分档 Color Bin Code (I_f=20mA)

color no	X1	Y1	X2	Y2	X3	Y3	X4	Y4
N9	0.2747	0.2465	0.2677	0.2505	0.2612	0.2385	0.2682	0.2345
O9	0.2812	0.2585	0.2742	0.2625	0.2677	0.2505	0.2747	0.2465
P9	0.2877	0.2705	0.2807	0.2745	0.2742	0.2625	0.2812	0.2585
Q9	0.2942	0.2825	0.2872	0.2865	0.2807	0.2745	0.2877	0.2705
R9	0.3007	0.2945	0.2937	0.2985	0.2872	0.2865	0.2942	0.2825
S9	0.3072	0.3065	0.3002	0.3105	0.2937	0.2985	0.3007	0.2945

● 信赖度测试项目及条件 Reliability Test

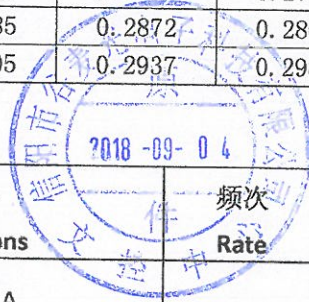

NO.	测试项目 Test Item	测试条件 Test Conditions	频次 Rate	允许破坏数 Number of Damaged
1	寿命测试 Operation Life	测试电流:20mA 温度: 25°C	1000hrs	0/20
2	高温高湿 High Temperature High Humidity Storage	湿度:90%RH 温度: 65°C	240hrs	0/20
3	高温储存 High Temperature Storage	高温温度: 100°C	1000hrs	0/20
4	低温储存 Low Temperature Storage	低温温度: -40°C	1000hrs	0/20

LC-S01-WB-B22H 产品规格书

文件编号 GMA-XY-W-D-287B0

制定部门 开发科

此文件为信阳市谷麦光电子科技有限公司的机密文件，未经许可，不能复制或发给外间机构

5	冷热冲击 Thermal Shock	-40°C~+100°C 20min 10S 20min	100cycle	0/20
6	回流焊 Reflow	预热温度:150°C-180°C,不到2分钟. 操作加热温度:220°C不超过60秒, 260°C(Max)不超过10秒	2times	0/20
7	静电测试 ESD(HBM)	<p>- R1:10MΩ, R2:1.5kΩ, C:100pF</p>	20	0/20

信赖度实验不合格判定标准 Reliability test is not qualified standard:

IV: 衰减超过30%
IV: attenuation above 30%

VF: 变化超过20%
VF: changes above 20%

●使用注意事项 Points for Attention



1. 焊接 Soldering

- LED 封装胶较软，外力易损坏发光面及塑料壳，焊接时要轻拿轻放。
LED encapsulation adhesive force is soft, light and the plastic shell is easy to damage, lightly move it when welding.
- 建议使用免洗型的助焊剂，依照回流曲线条件进行焊接，回流次数最多两次，确保LED发光面干净。
Recommend using a leave-in flux, processing according to reflow soldering conditions (curve). Max reflow twice, ensuring a clean LED light-emitting surface.
- 建议使用25W防静电烙铁进行手动焊接，镊子、焊头不可碰及发光面和塑料件，且焊接时间不超过3秒。
Recommend manual welding with 25W antistatic soldering iron, do not touch the light-emitting surface and the plastic parts with tweezers and the weld head, welding time can not beyond 3 seconds.
- 焊接及实验过程中，不可用力扭曲LED，后果会造成死灯。
When soldering or testing, the LED can not be twisted forcibly, or there will have the dead light.
- 不要在同一单元板上焊接不同BIN级产品，否则会产生色差。
Do not weld with different BIN products on one unit plate, if not, may cause the color difference

2. 回流焊条件 The reflow conditions

- 预热: 150°C~180°C±5°C, 时间两分钟内。
Preheating: 150°C~180°C±5°C, within 2 minutes.
- 焊接条件: 220°C 持续60秒 (max); 260°C(Max)持续10秒(Max); 逐渐冷却 (避免淬火)。
Operation heating: 220°C over time 60 sec max; 260°C (Max.) within 10 sec. (Max) Gradual Cooling (Avoid quenching).
如下图所示:

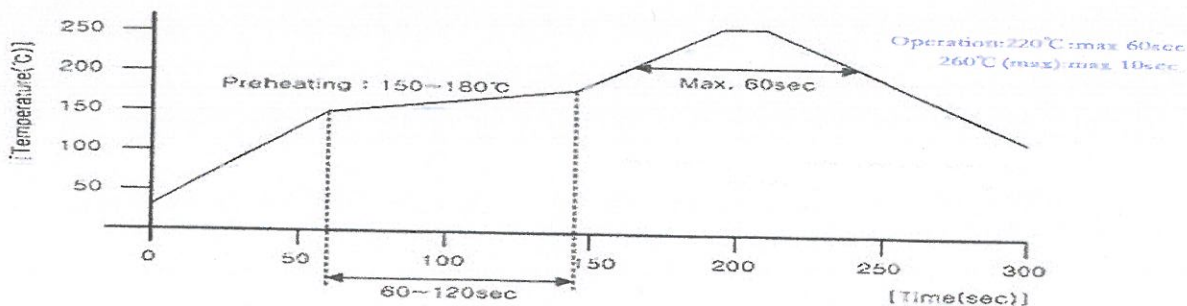

GMA	信阳市谷麦光电子科技有限公司 XINYANG CITY GMA OPTOELECTRONIC TECHNOLOGY LIMITED	规格书	
	LC-S01-WB-B22H 产品规格书	文件编号	GMA-XY-W-D-287B0
此文件为信阳市谷麦光电子科技有限公司的机密文件, 未经许可, 不能复制或发给外间机构		制定部门	开发科

3.测试 Test

a.LED要在额定电流下驱动, 同时电路中需要加限流电阻保护, 否则, 轻微的电压变化就会引起较大的电流变化, 从而破坏LED.

To drive LED at rated current, the circuit need to add resistance protection, current limit, otherwise, Slightly changes of voltage will cause great changes of current, thus the LED will be destroyed.

b.在电路导通或关闭情况下, 要避免瞬间浪涌电压的产生, 否则, LED可能会被烧坏。

Under the conditions of the circuit is on or off, avoid the instant surge voltage, or the LED will burn out.

c.点亮或测试LED时, 加在LED两端的反向电压不得高于5V, 否则容易损伤LED。

When light or test LED, the reverse voltage on two LED ends shall not exceed 5V, otherwise it is easy to damage the LED.

4.储存 Storage

a.打开包装前, LED应储存在温度30°C或以下, 相对湿度在60%RH以下, 一年内使用。

Before opening the package, LED should be stored below the temperature of 30 °C, the relative humidity is below 60%RH, to use within one year.

b.打开包装后, LED在温度30°C或以下, 相对湿度在30%RH或以下, 使用时间为3天; 在室温, 相对湿度大于35%RH的环境下, 使用时间为4天;

After opening the package, LED at a temperature of 30 DEG C or below, the relative humidity in 30%RH or below, to use within 3 days; At room temperature, the relative humidity is greater than the 35%RH, to use within 4 days;

c.LED受潮后, 回流焊时可能裂胶, 此时请进行去潮处理 (对于卷装品: 烘烤70±5°C, 12小时; 对于散装品: 烘烤105±5°C, 1小时), 而后用铝防潮袋密封后保存。

After LED damped, when reflow, the gum may crack, so the damped LEDs need to dry (roll packing: baking 70 ± 5 °C, 12 hours; bulk packing : baking 105 ± 5 °C, 1 hours), and sealed with aluminum moisture proof bag.

5.特别说明 Special description

a.亮度偏差允许 ± 3%

Iv : Tolerance for each Bin Code is ± 3 %

b.色度坐标偏差允许±0.005

Color : Tolerance for each Bin Code is ±0.005

c.电压偏差允许±0.05V

VF: Tolerance for each Bin Code is ±0.05

d.客户在使用过程中, 为避免因批次不同, 或客户的存货累计批次不同, 而导致的颜色差异等情况, 请留意标签上的Part No、Lot No、BIN的内容。

Customers in the use process, in order to avoid because of the different batches, or customer inventory accumulative batch is different, due to the color difference, etc., please pay attention to the Part No on the label, Lot No, the content of the BIN.

e.在生产相同批次的订单时, 尽量使用同色区等级、同亮度等级、同电压等级的灯珠。

In the production of the same batch order, use the same color as far as possible level, with the brightness level, with voltage grade lamp bead.

f. 以上说明, 客户注意使用可尽量减小颜色的差异, 但白光的特殊性, 以及客户使用过程中的变差, 并不能确保客户使用过程中不会因为其他差异导致色差产生, 具体视使用情况而定。

Above shows that the customer pay attention to use can minimize the color difference, but the particularity of white light, and the variation in the process of customers to use, and can't ensure that the customer won't because other differences result in color difference in use process, the specific depending on usage.

g. 装配及使用过程中, 禁止挤压到LED胶面。

It is forbidden to press into LED glue during assembly and use.

